

MAINE DEPARTMENT OF INLAND FISHERIES AND WILDLIFE
Chandler E. Woodcock, Commissioner

Research & Management Report

2013



TABLE OF CONTENTS

GREETINGS	3
BUREAU OF RESOURCE MANAGEMENT	4
FUNDING WILDLIFE AND HABITAT STEWARDSHIP	5
THE RESEARCH AND ASSESSMENT SECTION: AN IFW SOURCE FOR SCIENTIFIC INFORMATION	6
ENDANGERED AND THREATENED SPECIES CONSERVATION	7
Second Chances for “Species at Risk”...As Well As for MDIFW’s Conservation Program	7
Bald Eagles - They’re back!.....	8
INFORMATION FOR HABITAT CONSERVATION AND MANAGEMENT.....	10
Beyond Mapping - GIS analyses for Fish and Wildlife	10
Knowing is Half the Battle - Fact Sheets for Fish and Wildlife Datasets	11
Pre-application Screening and Environmental Review.....	12
Oil Spill Response	12
Emerging Technologies.....	12
BIRD CONSERVATION AND MANAGEMENT.....	13
New Avenues for Bird Conservation Funding and Data Collection	14
Habitat Selection and Nest Predation of Rusty Blackbirds in Maine’s Working Forest	15
IFW’s Raptor Program Takes a New Turn	16
Game Birds.....	17
Researchers Investigate Common Eider Survival Rates.....	19
MAMMAL CONSERVATION AND MANAGEMENT	20
White-tailed Deer.....	21
Disease Monitoring in Deer and Moose	24
Moose.....	27
Black Bear	29
Canada Lynx	32
Furbearers and Small Game Mammals.....	33
Bats and White-Nose Syndrome	35
New England Cottontail.....	35
REPTILE, AMPHIBIAN, AND INVERTEBRATE CONSERVATION AND MANAGEMENT.....	37
Amphibians and Reptiles.....	37
Invertebrates.....	39
Special Habitats for Reptiles, Amphibians, and Invertebrates.....	43
FISH CONSERVATION AND MANAGEMENT	44
Brook Trout Stream Habitat: It’s All About Access and Diversity	44
REGIONAL FISHERIES MANAGEMENT	47
ILLEGAL INTRODUCTION OF LARGEMOUTH BASS IN THE ST. CROIX RIVER DRAINAGE.....	47
HABITAT VARIABLES INFLUENCING THE RETURNS OF HATCHERY-REARED FALL-YEARLING BROOK TROUT IN MAINE LAKES.....	48
NEW DRY MILLS HATCHERY EDUCATION BUILDING WILL FASCINATE AND INFORM VISITORS OF ALL AGES.....	49
REGIONAL WILDLIFE MANAGEMENT.....	50
WILDLIFE MONITORING AND MANAGEMENT	50
WILDLIFE HABITAT ACQUISITION AND MANAGEMENT.....	50
ENVIRONMENTAL REVIEW.....	50
TECHNICAL ASSISTANCE AND PUBLIC OUTREACH.....	51
MANAGING MAINE’S WILD TURKEYS	51
PUBLIC VALUES CONSERVED BY THE DEPARTMENT OF INLAND FISHERIES AND WILDLIFE	52
TURKEY VIRUSES IN MAINE’S WILD TURKEY POPULATION.....	54

Cover Images: Bald eagle carrying stick, photo by Sharon Fiedler.
Eagle nest in tree, photo by Erynn Call.





STATE OF MAINE Department of Inland Fisheries and Wildlife



Our Main Number: 1-207-287-8000



Greetings,

This 2013 Research and Management Report highlights many of the projects the Department is engaged in and is the evidence of countless hours of effort on the part of the professional research and management staff at the Maine Department of Inland Fisheries and Wildlife (MDIFW). Our biologists assist the decision-makers of MDIFW in fulfilling our mission to preserve, protect, and enhance our fisheries and wildlife resources.

Maine is fortunate to have such exceptional biologists, and I want to thank them for their work and dedication to our mission. The work that we do here in Maine is often used as a model by others to effectively manage regions outside Maine.

Enjoy the materials contained within. If you have any questions, please contact MDIFW. Thank you.

Chandler Woodcock
Commissioner

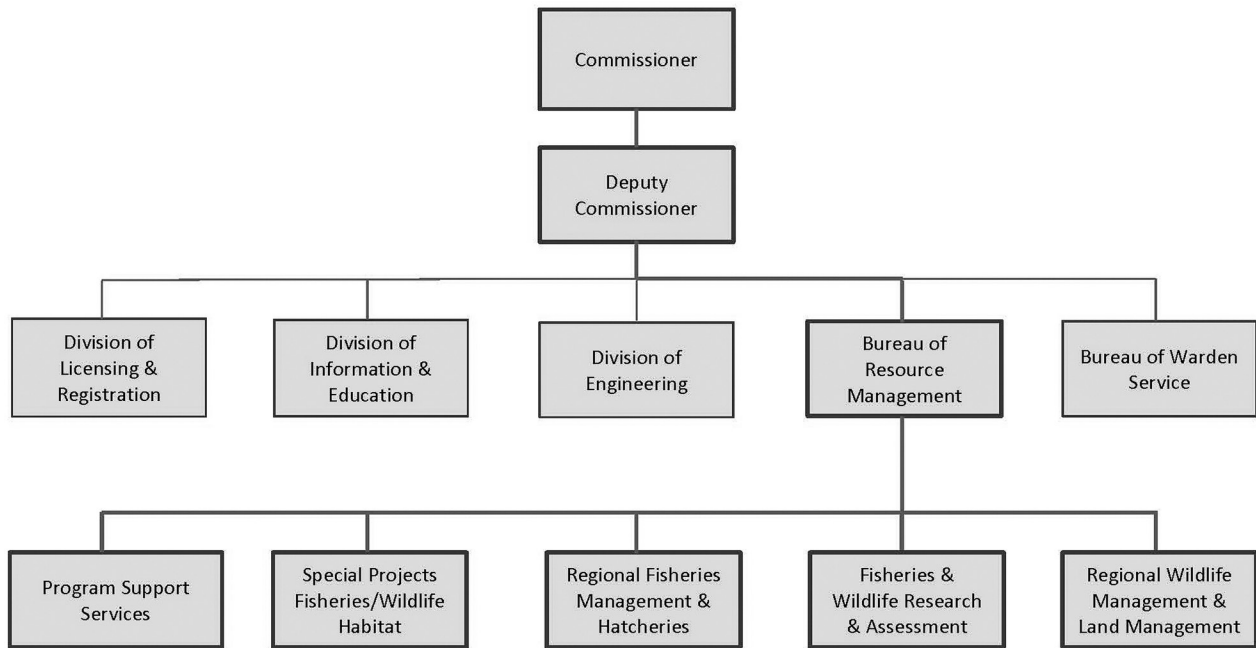

These studies are financed in part through Federal Aid in Wildlife Restoration Funds under Projects 81D, 82R, and 83C, and through the Endangered Species Conservation Act.

The Department of Inland Fisheries and Wildlife receives Federal funds from the U.S. Department of the Interior. Accordingly, all Department programs and activities must be operated free from discrimination in regard to race, color, national origin, age or handicap. Any person who believes that he or she has been discriminated against should write to The Office of Equal Opportunity, U.S. Department of the Interior, Washington, D.C.



BUREAU OF RESOURCE MANAGEMENT

Maine is a land rich in contrasts between the boreal and temperate, freshwater and saltwater, upland and wetland, and alpine and lowlands. The state has enormous natural variety and owes its biological wealth to its:

- 21.3 million acres – State of Maine,
- 17.5 million acres of vast forests & rugged mountains,
- nearly 6,000 lakes and ponds,
- 5,000,000 acres of wetlands,
- 36,000 miles of rivers and streams,
- 4,100 miles of bold coastline, and
- 4,613 coastal islands and ledges.

This mosaic of diverse physical settings supports a wide diversity of wildlife that can be equaled in few other states. Maine is also a transition area, and its wildlife resources represent a blending of species that are at or approaching the northern or southern limit of their ranges;

- 292 bird species (~40 species can be hunted),
- 58 non-marine mammal species (20 can be hunted/trapped; caribou, puma, and wolf populations are considered locally extinct [extirpated]),
- 20 reptile species,
- 18 amphibian species,
- 56 inland fish species,
- 313 marine chordate, fish, and mammal species
- >16,000 invertebrate species,
- 2,100 plant species,
- 310 phytoplankton species,
- 271 macrophyte (aquatic plant) species, and
- 3,500 fungi species.
- (These have been documented, but experts believe many times these numbers actually exist.)

With such an abundance of resources, why does the State need to manage them?

During the 1800s, there was uncontrolled taking of wildlife, leading to significant population declines with several species. Fourteen species have been extirpated from the State, and 44 species are currently on the State's Threatened and Endangered Species list.

Today, we have many groups competing for these public resources: hunters, trappers, wildlife viewing, eco-tourism, other recreational activities, and private development. As such, the Department is focused on the protection and enhancement of the state's inland fisheries and wildlife, while at the same time providing for the wise use of these resources.

In addition, assuring the conservation and use of these resources is vital to the state's economy. Fish and wildlife continue to be highly valued by Maine people and to the hundreds of thousands of people who come to Maine each year. Direct economic impacts attributable to the use of these resources amount to over \$2.4 billion dollars annually and play a major role in the State's economy.

Which resources do we manage for, and how?

Detailed studies of the status and needs of fish and wildlife began by the Department in the 1940s to help guide their management. Armed with better information, the Department's species planning effort began in 1968. Recognizing that many species' survival depends on an appropriate supply of quality habitat, our Beginning with Habitat program was initiated in 2000. This program has a history of public involvement and collaboration among conservation partners, working together to improve planned development and conservation efforts. More recently, Maine's Comprehensive Wildlife Conservation Strategy was developed in 2005, which went a step further to provide a vision for Maine and guide us toward that vision. This written Strategy now needs updating over the course of the next year; we'll get to thoroughly assess how well we have been doing, what's working, and what is not.

This annual Research and Management Report presents a glimpse at the significant amount of work the Bureau of Resource Management staff do for you and our resources. As explained in more detail later on, the Bureau is made up of our regional fishery and wildlife staff that serve as your local experts and our research & assessment staff that serve as the state's species experts. The Bureau has a Program Support Section and a Special Projects biologist, who exist to help others and enact other important projects, crucial to functioning of our game and fish and wildlife diversity programs.

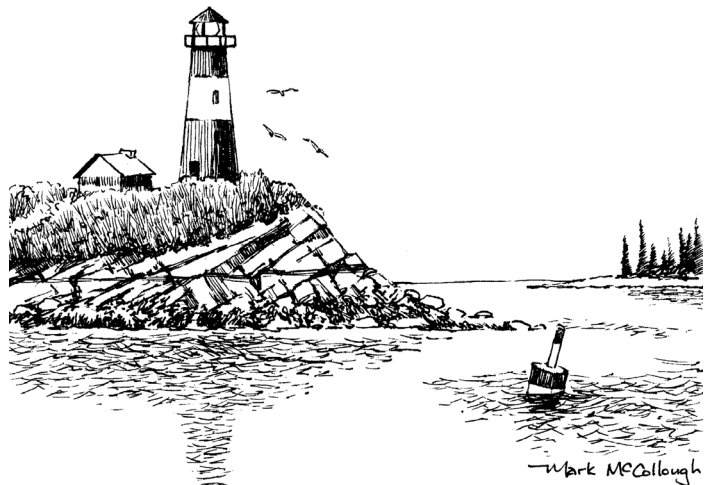

FUNDING WILDLIFE AND HABITAT STEWARDSHIP

Many staff salaries and most of the administrative costs of the Wildlife Division's conservation and management programs for birds and mammals are funded by federal Pittman-Robertson Funds [FY13 \$3,272,274]. Pittman-Robertson (PR) Funds are derived from an 11% federal excise tax on sporting arms, ammunition, and archery equipment, and a 10% excise tax on handguns. Pittman-Robertson Funds require state matching dollars at a ratio of 1:3 in our favor, which come from a portion of the hunting license revenues [FY13 \$1,359,428].



The Wildlife Division also receives federal funding for the management of species of greatest conservation need in the form of State Wildlife Grants (SWG), originating from royalty payments made by petroleum industry operating on federal lands [FY13 \$477,284]. Also, there is the so-called "Section 6" funds from the U.S. Fish and Wildlife Service for the recovery of threatened and endangered species or to help recover a species before it becomes 'listed' under the federal Endangered Species Act [FY13 \$26,000].

Volunteer contributions to the dedicated Endangered and Nongame Wildlife Fund via the tax-form "Chickadee-Checkoff" and purchases of Loon Conservation License Plates provide the core State funding for Maine's nongame and endangered species programs [FY13 \$315,145]. All donated money is deposited into the dedicated Maine Endangered and Nongame Wildlife Fund, which is a special, interest-bearing account from which money can only be spent for the conservation of Maine's nongame wildlife that includes rare, threatened, or endangered species (Table 1). This dedicated Fund is used to match and spend the federal SWG grants, just as revenues from hunting licenses and tags are used to match and leverage PR-grant \$s for the conservation and management of birds and mammals.



The Maine Outdoor Heritage Fund, derived from the sale of conservation instant-scratch lottery tickets, can also provide an important source of "State" funding for Maine's wildlife conservation programs. The Division also receives funding from the Oil Spill Conveyance Fund [FY13 \$21,506], which is used for oil spill preparedness and response.

Throughout the pages of the 2013 Research & Management Report is a summary of last year's accomplishments with much help from our conservation partners. You will see how efficiently we can assess fish and wildlife resources and habitats using cooperative partnerships, volunteer assistance, and new technologies. There is always need to do more.

Table 1. A history of income derived from the "Chickadee Check-off," Loon Plate, and Maine Outdoor Heritage Fund to benefit wildlife programs.

Year	Chickadee Check-off				Loon License Plate		Maine Outdoor Heritage Fund	
	Total Given	Number of Givers	Average Donation	% of Taxpayers Giving	Income to MDIFW	Number of Registrations	Income to MDIFW	Number of Projects Funded
1985	\$129,122	29,200	\$4.42	6.0%				
1986	\$112,319	26,904	\$4.17	5.4%				
1987	\$114,353	26,554	\$4.31	5.2%				
1988	\$103,682	24,972	\$4.15	4.8%				
1989	\$93,803	20,322	\$4.62	3.6%				
1990	\$88,078	18,332	\$4.80	3.2%				
1991	\$92,632	19,247	\$4.81	3.4%				
1992	\$95,533	18,423	\$5.18	3.2%				
1993	\$82,842	15,943	\$5.20	2.8%				
1994	\$84,676	10,863	\$7.79	2.0%	\$335,042	59,829		
1995	\$81,775	10,014	\$8.17	1.8%	\$457,307	81,662		
1996	\$90,939	11,024	\$8.25	2.0%	\$535,679	95,657	\$112,232	3
1997	\$77,511	8,686	\$8.92	1.5%	\$588,364	105,065	\$133,971	5
1998	\$48,189	4,065	\$11.85	0.7%	\$617,484	110,265	\$184,109	7
1999	\$47,908	3,775	\$12.69	0.7%	\$569,610	101,716	\$121,436	5
2000	\$44,496	3,297	\$13.50	0.6%	\$499,486	89,194	\$323,884	11
2001	\$49,348	3,713	\$13.29	0.6%	\$458,057	81,796	\$148,408	5
2002	\$50,412	3,661	\$13.77	0.6%	\$446,342	79,704	\$172,191	8
2003	\$55,348	3,792	\$14.60	0.6%	\$425,147	75,919	\$184,129	5
2004	\$43,158	3,234	\$13.35	0.6%	\$402,695	69,615	\$234,126	10
2005	\$36,769	2,931	\$12.54	0.5%	\$381,948	67,814	\$154,656	7
2006	\$36,865	2,924	\$12.60	0.5%	\$367,791	65,677	\$116,121	6
2007	\$37,209	2,852	\$13.04	0.5%	\$355,180	63,425	\$141,526	6
2008	\$34,929	2,757	\$12.67	0.4%	\$333,536	59,560	\$141,059	7
2009	\$33,751	2,688	\$12.56	0.4%	\$316,148	56,455	\$56,128	3
2010	\$31,466	2,423	\$12.99	0.4%	\$303,121	54,237	\$10,906	2
2011	\$29,454	2,357	\$12.50	0.4%	\$282,005	50,358	\$88,398	8
2012	\$38,623	3,021	\$12.78	0.5%	\$277,207	48,072	\$26,500	2

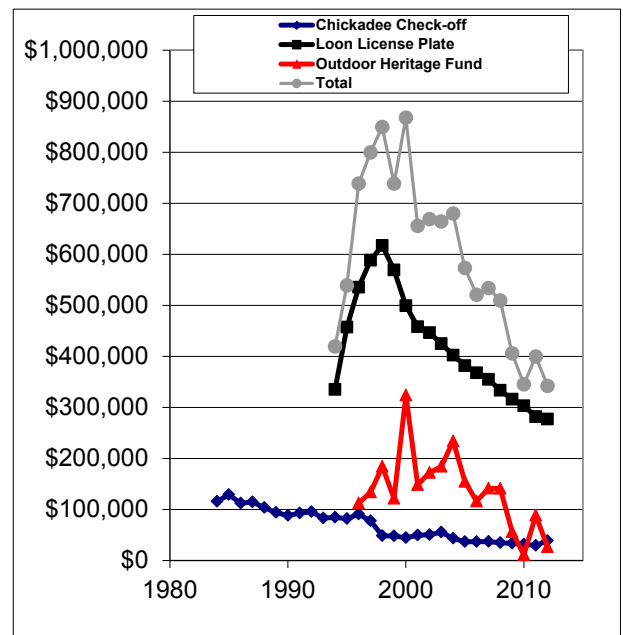

THE RESEARCH AND ASSESSMENT SECTION: AN IFW SOURCE FOR SCIENTIFIC INFORMATION

The past couple of years I have used this space to help introduce this Section of MDIFW to the reader. I have previously described for the reader who we are and, generally, the roles that this Section of IFW plays, in that we try to seek, document, and disseminate reliable information to those who wish to have it. The fish and wildlife of Maine are public resources held and managed by your State in trust. As your public-resource trust managers, it is our duty to make sure that you know how your resources are doing to our best ability. This annual report is one attempt at that, but feel free to give us a shout anytime you cannot find the information that you desire. Here are a few details about what we've been up to this past year.

We have a new website, and it's pretty cool. It was a lot of work, but I think you will find that it serves you better. One thing you will find on our home-page is a link to annual reports to the Legislature, including our annual report on Maine's dedicated Endangered and Nongame Wildlife Fund. While the report reads pretty bleak, we are working on it and have convened an internal working group to brain-storm ideas for recovering contributions into the Fund. We use the Fund as match to federal grants towards conservation efforts for Maine's species of greatest conservation need. The good news: we put out a request for increased donations to the Chickadee-Checkoff last spring, and folks responded with a one-time 31% increase. If this level of contributions can be maintained, the Checkoff will be saved. Many thanks from us to you.

In January 2010, we reported back to the Legislature's IFW Joint Standing Committee on a resolve to ensure transparency in the funding of certain programs within the Department. We try to do that in this report in a couple ways. In the front of the report, we describe our wildlife funding sources at the grant level. Later in the report, you can read how each project is funded following our described activities. I hope this helps resolve any concern that we spend too much hunting revenue on research and management efforts for our nongame and threatened species...enough on funding.

Our Information and Education Division has spent a good deal of time posting informational bits and production pieces to YouTube. There is a piece celebrating our storied Maine Warden Service. You can find other IFW-produced videos such as: "*A Wicked Good Deal for Maine*", "*Maine: a World-Class Fishery*", "*The Maine Black Bear: a Symbol of the Wild, an Icon of Our State*", and "*Maine: from Moose to Mayflies*". It's that last one I'd like to reflect on a bit.

Exciting news: the 125th Legislature created a dedicated moose research and management fund that draws from nonresident moose hunting permits (no, we're not increasing nonresident chances of winning). We're looking into conducting some field research on moose with questions looming about moose survival at the southern extent of its range in North America. There could potentially be some negative influences from longer growing seasons and increased prevalence and activity of pathogens and parasites, as seen elsewhere in the Lower-48 states.

We have a new deer biologist and with the help of Regional Wildlife Biologists in the Wildlife Division's Management Section, there will be Any-Deer permits in Wildlife Management Districts 3 & 6 for the first time in many years. See what a couple fairly mild winters can do for a healthy deer herd? We just wrapped up a 12-year field study of the elusive Canada lynx, and, as it turns out, not only do we have a breeding population in northern Maine, but they are doing great – expanding in both abundance and range. We're turning about 35 years of field experience in bear research into a modern management system with the help of some University researchers. We're kicking off a new research effort for marten too.

Bald eagles are back in a big way...from about 30 nesting pairs in the mid-1970s to well over 600 in 2013! We've been busy monitoring colony-nesting herons, banding geese for harvest and survival estimation, and sampling turkeys for disease surveillance. We are involved with research on the locally rare rusty blackbird in northern forest-wetlands and research into the resilience of coastal saltmarsh habitats and the songbirds that they support. We lend a hand to piping plovers nesting on Maine's southern coastal sand beaches.

We have written a couple dozen Incidental Take Permits for landowners in southern Maine who are willing to work cooperatively with us and our partners to create and perpetuate habitats for Maine's only endangered mammal – the New England cottontail rabbit. We are expecting a similar 3-way federal-state-private agreement soon, just in case the rabbit becomes federally listed too. The Penobscot River Restoration Project is very exciting, improving fish passage in the Penobscot River by creating a free-flowing river from Old Town to the ocean. We worked with the Trust that oversees the project to permit the taking of rare and State-listed mussels, as long as they try to save as many as possible, which has been done. And finally, we work through our environmental review process to protect rare mayflies that can be threatened by access roads and development in a few high-elevation areas. But hey, you can learn about it all from the real experts in the pages that follow. Enjoy.

--Shawn Haskell, Ph.D.
Research and Assessment Section Supervisor

ENDANGERED AND THREATENED SPECIES CONSERVATION

Second Chances for “Species at Risk”...As Well As for MDIFW’s Conservation Program

Within MDIFW, staffs have witnessed major changes in fish and wildlife management in this agency over the last 25–35 years. What’s so different? Have you noticed?

- A philosophical shift by MDIFW greatly expanded capacity to address conservation of so-called “nongame” species well beyond the limits of scant state funds for this topic. Game management has also benefitted from more focus toward habitat management, land conservation, and environmental reviews that are often an emphasis of nongame specialists.
- There is much less division of assignments in MDIFW (game versus non-game management). Biologists, wardens, and the entire staff can participate over the full range of species “from mayflies to moose.” We can see the synergy of combined missions that can focus on species guilds and special habitats.
- After decades of scrutiny and limited budgets, efforts to conserve Maine’s endangered or threatened species, as well as other species “at risk”, are widely valued. Maine’s Endangered Species Act (1975) has stood the test of time and seemingly with fewer rancors than its federal counterpart. 2013 marks the 40th year anniversary of the U.S. Endangered Species Act.
- Since 2001, “State Wildlife Grants” provide from \$1 to \$3 of federal funds to match each dollar of state spending for species at risk. Federal aid programs have long boosted state programs for management of fisheries (since 1950) and birds and mammals (since 1937) based upon excise taxes of equipment principally purchased by sportsmen.

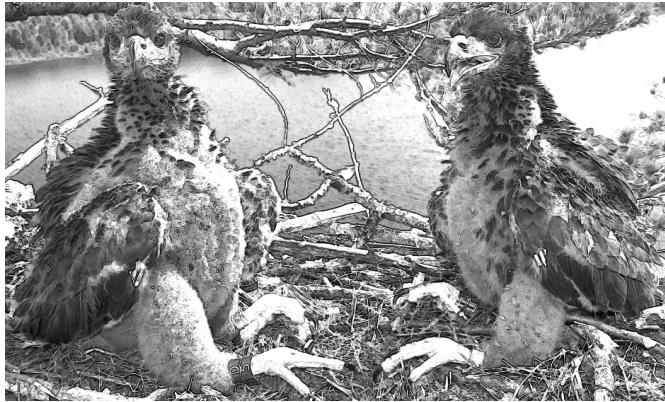

Photo Credit: Bill Hanson

Does this approach to the conservation and management of fish and wildlife diversity really work? It can, but a simple or quick fix is not to be expected. Species “at risk” typically face an array of challenges and need sustained attention over time. You can learn more in some of our featured species accounts in other sections of this report. Consider some of our successes:

- The program has steadily broadened in scope to new taxa over the decades with limited change in overall staffing. Citizen science is blossoming into a functional support role. Land conservation by agencies and partners has secured many priority locations via purchase or easement.
- Bald eagles numbered only 31 nesting pairs in 1975 before MDIFW involvement. A viable, remnant population was evident only Downeast. The species was listed as “Endangered” or “Threatened” in Maine from 1978 to 2009. An inventory of the recovered eagle population identified at least 630 nesting pairs statewide in 2013.
- Piping plovers and least terns persist in southern Maine coastal beach environments despite persistent, extreme, and varied threats. Like other species with severe limitations set by habitat or range, partnerships and local stewardship are invaluable.
- Concerns for the New England cottontail across its entire range now focus on recovery in Maine using unique agreements with private landowners to improve habitat conditions. This is a state-listed endangered species and under review for federal designation.
- Peregrine falcons were restored to Maine following a 25-year absence in the state. Maine’s breeding population ranks as the second largest amongst New England states.
- MDIFW worked with partners to develop a program that is a major outreach initiative to Maine communities to consider special habitats and encourage landscape-scale planning at the towns’ own desire.

There are notable deficiencies and outstanding needs. Most are directly or indirectly related to the lack of any stable funding.

- Voluntary donations are the only source of state funding to “at risk” fish and wildlife conservation efforts in Maine. Over time, donations have dwindled and now potentially leave us short of the ability to match federal aid for which the program is eligible.

- The Maine Endangered and Nongame Wildlife Fund is a dedicated fund for this program. Some of the best ways to support this fund is to:
 - buy a conservation registration “Loon Plate” for your vehicle,
 - donate via the “Chickadee-Checkoff” on your state income tax return (Schedule CP), or
 - make charitable contributions directly to the Fund.
- Few or no state dollars have been allocated from the general fund in the 31-year history of IFW’s nongame program. We can always redirect more resources to promoting these efforts and broaden program support, but most would rather focus on critical needs of vulnerable fish or wildlife species. One way or another, it is crucial that the constituency that values these special resources helps to subsidize a conservation effort.
- New challenges like invasive species and climate change constantly emerge and compound risks for some species. After long-lasting concerns for many bat species at or near their range limits in Maine, it is hard to fathom that such concerns have been trumped by the sudden and drastic impact of “white-nose syndrome” on little brown bats: previously our most common bat species and a keystone in nature’s balance, now possibly facing extinction.
- Our long-awaited “State Wildlife Grants” (SWG) remain vulnerable, with annual appropriation in Congress. Organizations and businesses can help leverage sustainable funding by joining Maine’s Teaming with Wildlife coalition; see <http://www.teaming.com/content/join-coalition>. The current (July) House budget has SWG zeroed-out; we’ll see.

State Wildlife Grants are intended to pre-empt critical levels of jeopardy for species and minimize the need to rely on regulatory aspects of endangered species policy. MDIFW biologists will begin the update to Maine’s list of Endangered and Threatened Species later this year. Predictably, the list will grow.

If you simply enjoy knowing that Maine’s rich fish and wildlife heritage is secure, if you are passionate about the risks to biodiversity in our state, or you relish related outdoor recreational pursuits...please consider a contribution to this program and support efforts for more broad-based funding. We can match even small gifts with federal grants, but a broader base of contributors is essential. Most agree these species deserve a “second chance.” I hope you agree that our program’s core funding does as well.

Bald Eagles – They’re Back!

A statewide survey of nesting bald eagles during 2013 revealed the continuation of a steady, broad comeback across Maine. Numbers soared to a minimum count of 630 nesting pairs. The last comparable effort was in 2008, which tallied 477 pairs. Annual growth rates since that time slightly exceed 6% and are virtually unchanged from yearly increases that fuelled population growth during the height of species recovery.

MDIFW began active surveys, research, and management of bald eagles in 1976. Prior to this involvement, only 31 nesting pairs could be found in Maine; only 5 were left in areas outside of the remnant stronghold in Downeast Maine.

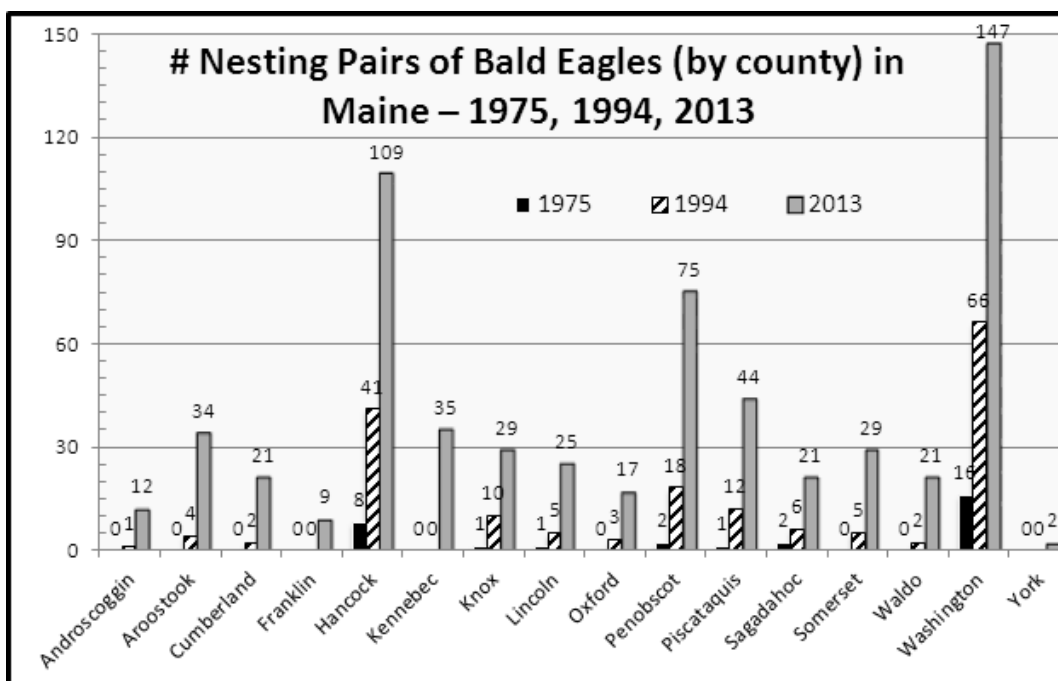

Many landowners voluntarily protected nests. MDIFW applied Essential Habitat rules for 19 years to bolster those safeguards and worked cooperatively with private landowners to conserve and recover this national symbol. Substantial gains by 1994 were still localized in eastern Maine: >71% of the population was in Washington, Hancock, or Penobscot County.

The dramatic range expansion since, into other regions of Maine, now safeguards the population from local risks. Numbers and density of eagle nests continue to rise Downeast, but the recovery is quickening elsewhere. The 13 counties combined, which had only 5 eagle pairs in 1975, now support nearly half of the statewide population. Recovery of endangered species is always a prolonged effort, especially when regional extirpation and significant loss of range are factors. After 31 years of recognition under the Maine Endangered Species Act, bald eagles were removed from Maine's list in 2009.

Wildlife biologists and Warden Service pilots at MDIFW conducted 190 hours of low-level aerial surveys to monitor eagles in 2013. Agency personnel have amassed >12,000 hours of aerial surveillance of the population since 1976. Warden pilots Durward Humphrey, Charlie Later, and Dan Dufault are uniquely experienced for these missions and are also keen eagle observers. Tom Schaeffer, Allen Starr, Brad Allen and I were lead observers. A host of biologists completed the 3-person crews: Rich Bard, Erynn Call, Mark Caron, Danielle D'Auria, Kendall Marden, Amy Meehan, Cory Stearns, and Brad Zitske.

We monitored nests for eagle residency and breeding activity from mid-March to early-May. Occupied nests were rechecked in June and early-July to evaluate nesting success and numbers of fledgling eaglets. Nesting productivity statewide during 2013 still exceeds 0.8 fledglings per nesting pair: an indication that diminished regulatory protection after delisting has not handicapped eagle reproduction in Maine.

Staff checked the vicinity of all 1,637 individual nest locations found during a 50-year monitoring effort in Maine; these were in 689 different nesting territories. A total of 153 new nests were located in 2013 while searching other suitable habitats. Forty-one were in new nesting territories, and 112 others were alternate nest locations of established pairs that shifted locations since previous monitoring 1–5 years earlier.

Plots of all 768 nests found to be intact during 2013 can be viewed via an internet mapping service hosted by the U.S. Fish and Wildlife Service – Maine Field Office. MDIFW mapped the nests, and USFWS provides consults. See <http://fws.maps.arcgis.com/explorer/?open=5aa77d8ff7bc419f82a1a26d5712262b>.

A federal law, the Bald Eagle – Golden Eagle Protection Act, now serves as the primary legal standard for bald eagles in Maine. National Management Guidelines and suggestions for avoiding disturbance to eagles are available at this weblink: <http://www.fws.gov/northeast/EcologicalServices/eagle.html>.

MDIFW staff will continue to provide technical assistance to landowners and conservation partners. Agencies and cooperators now own or hold easements to protect at least 250 eagle nest territories across Maine. This “safety net” helps to defend some eagles from constant threats on shoreline habitats that can be related to weather, aging nest trees, or human-impacts. For additional information on life history, nesting ecology, and research updates of Maine's bald eagles, see the MDIFW website at: <http://www.maine.gov/ifw/wildlife/species/birds/baldeagle.html>.

Operational costs for the 2013 eagle survey work were fully covered via contract with the USFWS' Maine Field Office. MDIFW personnel time is supported by federal aid funds from the Pittman–Robertson program for wildlife restoration and federal State Wildlife Grants for conservation of species “at risk”, as well as state revenues from the Loon Conservation Plate and Chickadee-Checkoff funds.

--Charlie Todd
Endangered and Threatened Species Coordinator

“The last word in ignorance is the man who says of an animal or plant, “What good is it?” If the land mechanism as a whole is good, then every part is good, whether we understand it or not. If the biota, in the course of aeons, has built something we like but do not understand, then who but a fool would discard seemingly useless parts? To keep every cog and wheel is the first precaution of intelligent tinkering.”

— Aldo Leopold (Round River, 1953, published posthumously)

HABITAT GROUP

We use Geographic Information System (GIS) software to map observations of wildlife and habitats. These data are used for developing species assessments and management plans, habitat conservation, and oil spill response planning. Most of these wildlife habitats are defined and protected by state or federal law. Some datasets change or grow as new observations are collected during field surveys. Mapping new data is a significant part of the daily work of Habitat Group staff. Other datasets change little between major upgrades, which occur when there are legislative or policy changes that require different mapping or when new technologies allow a significant increase in mapping resolution. The availability and quality of aerial photos has improved dramatically in recent years and provides an opportunity to upgrade some of our wildlife habitat maps. These statewide upgrades are intensive and can take years to complete. Currently we are updating inland wetland habitats in northern Maine and salt marshes and mudflats along the coast.

Donald Katnik, Ph.D., Habitat Group Leader - Supervises Group activities and coordinates habitat-related projects with other Department staff and other State and Federal agencies.

Jason Czapiga, GIS Coordinator - Develops, maintains, and analyzes databases of wildlife observations and habitat. Provides assistance to other Division biologists to assess species' habitats on a statewide basis.

Amy Meehan, Wildlife Biologist and GIS Specialist - Collects wildlife habitat data from Regional Wildlife Biologists and others. Creates and maintains computer databases. Conducts field inventories of wildlife habitat and provides Geographic Information Systems (GIS) support for a variety of projects.

MaryEllen Wickett, Ph.D., Wildlife Biologist and Programmer/Analyst - Develops computer applications to facilitate access to habitat data by MDIFW staff and other users. Provides technical support and habitat data analyses for landscape planning efforts and development of species' habitat models.

Vacant, Oil Spill Biologist - Coordinates oil spill response planning efforts for the Department including identifying and prioritizing sensitive areas, developing wildlife spill response plans, rehabilitation of oiled wildlife, and training.

INFORMATION FOR HABITAT CONSERVATION AND MANAGEMENT

Beyond Mapping – GIS Analyses for Fish and Wildlife

London, 1854. A massive cholera outbreak is underway and a physician named John Snow has plotted the locations of the victims on a map of the London streets. He notices a pattern emerging, in that most of the victims live near or have had reason to access a water pump on Broad Street. This eventually leads him to conclude that the cholera outbreak has resulted from a contaminated well, and not from "bad air", as was the thought at that time. This is also possibly the first known instance of spatial analysis.

Had Snow had access to a GIS, he could have assigned attributes to each point on the map, such that one point could have represented one victim, or an entire household. Then using the GIS, he could have had the computer conduct a statistical analysis known as a "Hotspot Analysis", to statistically determine where the most cases of cholera were occurring. As it was, he did use statistics and what is now known as a "Voronoi diagram" to make his case that the cholera was coming from a contaminated well.

Today, GIS analyses are used in many, many different fields from emergency management, to development planning to wildlife management. In wildlife management, however, our points might represent lynx or bear locations instead of cholera victims, and instead of overlaying those points on a street map of London, we overlay them on a map of forest or habitat types in northern Maine. We can then use the GIS to perform analyses of habitat preferences of lynx, and discover that statistically, lynx prefer to use sapling-stage conifer forests far more than mature hardwood areas. Or we can estimate the size and overlap of lynx home ranges, to help us determine not only how much area a lynx needs to thrive, but also to calculate estimates of potential population size and density (i.e. how many lynx per square mile). As one can see, a GIS is not merely a computer system for making maps, although it can do that. But a GIS is an analytical tool that allows one to identify relationships between spatial features. There are 5 basic questions a GIS can answer about spatial data:

1. Location, or What features are at a particular location?
2. Condition, or Where do certain conditions exist?
3. Trends, or What has changed since...?
4. Patterns, or What spatial patterns exist?
5. Modeling, or What if this happens...?

As wildlife researchers, we frequently need answers to all of these questions, and this is where the advanced functionality of GIS comes in.

This year, MDIFW biologists worked with Warden Service pilots to conduct a statewide survey of Bald Eagles to determine population numbers, occupancy rates, and nesting success. We have been using hand-held Global Positioning System (GPS) units in the plane to record our flight tracks, which we then plot in the GIS. This enables us to keep track of the areas that have been searched and areas that still need to be searched.

We will then plot the nest locations and can use these locations to determine nest densities, such as nests per square mile or nests per mile of shoreline, in different areas of the state and compare these densities over time to track population recovery. The eagle nest layer in our GIS is linked to a database that tracks nest productivity, allowing us to also determine which geographic areas might be more or less productive, and by linking this to habitat features, we can determine why one region might be more productive than another.

There are many other examples of our use of GIS analyses ranging from bear density estimates, to the use of habitat by rare black racer snakes, to the movement patterns of golden eagles. All of them illustrate how GIS has become an indispensable tool for the management and conservation of wildlife species in Maine.

--Amy Meehan



Knowing is Half the Battle — Fact Sheets for Fish and Wildlife Datasets

The Maine Department of Inland Fisheries and Wildlife (MDIFW) Geographic Information System (GIS) includes a variety of habitat datasets that encompass numerous diverse applications. These applications include, but are not limited to, species assessment and management, conservation planning, habitat protection/restoration outreach, and regulation. Many of the datasets are driven by laws including the Natural Resource Protection Act with its defined Significant Wildlife Habitats and the Maine Endangered Species Act with its defined Essential Habitats.

Because of the complexity of the datasets and the limited knowledge on how to access GIS metadata, which tells much more about each species observation or mapped polygon, we created “fact sheets” to explain each dataset and deliver it in an accessible format. These fact sheets provide users with a detailed description of each dataset by presenting details about the history, purpose, limitations, geographic extent, accuracy, and update status of each dataset. By empowering users with better access to detailed information about our data, we hope to promote appropriate and productive use of these valuable data and broaden the public knowledge of the MDIFW GIS datasets. The fact sheets will be available via our website...look for them soon!

This work is supported by federal State Wildlife Grants, the federal Pittman-Robertson Funds program, and state revenues from the Loon Conservation Plate and Chickadee Check-off Funds.

--Jason Czapiga

Pre-application Screening and Environmental Review

Many state agencies, including MDIFW, conduct “permit reviews” relative to the resources they are mandated to protect. These reviews first determine whether any permits are needed for the proposed activity (“pre-application screening”). Each agency then recommends how the applicant may best avoid, minimize, or mitigate for specific resource loss according to Maine law. Environmental Review tracking—recording the status, habitat concerns, and recommendations for each project—is important for ensuring consistency and transparency in the process and for monitoring cumulative impacts. We now have an Environmental Review database that stores information for each project including the applicant, project type, habitat concerns, issues and recommendations raised by species’ specialists and regional biologists, and the final agency recommendation. The database can be searched for previous recommendations made on similar projects and to analyze spatial trends. A report can be generated to show the current status of every ongoing review. Cumulative impacts to specific habitat resources can be assessed. The Environmental Review database uses a GIS Search Tool that automatically overlays project footprints with habitat data, summarizes the results in a detailed report, creates a map, and writes the initial draft response letter for the appropriate biologists to review; it runs at night with results ready to go in the morning.

This work is supported by federal State Wildlife Grants, the federal Pittman-Robertson Funds program, and state revenues from the Loon Conservation Plate and Chickadee Check-off Funds.

--Don Katnik

Oil Spill Response

As a state Natural Resource Trustee, MDIFW is obligated to respond to oil spills that affect wildlife or wildlife habitat. Fortunately, we had no significant spills that impacted wildlife or wildlife habitats this past year. Knowing where the most vulnerable wildlife resources occur is critical to effective spill response. During the initial hours of an incident, responders would implement predetermined “geographic response strategies” that depict specific boom deployments to protect coastal resources. Habitats differ in their sensitivity to being oiled, ability to be restored, and irreplaceability. Besides mapping locations of wildlife resources at risk, the Habitat Group also has been working with the Maine Department of Environmental Protection and the Department of Marine Resources to prioritize habitat areas for protection.

This work is supported by the Maine Coastal & Inland Surface Oil Clean-up Fund.

--Don Katnik

Emerging Technologies

Light Detection and Ranging (LIDAR) is a relatively new method of remote sensing used to examine the surface of the Earth. LIDAR uses a pulsed laser to measure the “range,” or distance from the sensor (usually in an aircraft) to the Earth’s surface. As the sensor moves over the Earth, literally millions of data points are collected, creating a rich, three-dimensional image. LIDAR data can be used to generate maps of the Earth’s topography at much higher resolution than was possible using previous technologies. Of significant importance to mapping wildlife habitats, LIDAR data also reveal the heights of different layers of vegetation above the ground. Habitat Group did some preliminary work with LIDAR data to assess its potential for mapping wetland footprints, coastal mudflats, and shrub heights in early successional habitats. The vast quantities of information collected by LIDAR are still a struggle for most computer software to handle efficiently. Timing of the collection relative to annual seasons (leaf-off versus leaf-on) and tide levels is critical to its usefulness for mapping certain habitats. Nonetheless, we expect that this emerging technology will dramatically affect our ability to map wildlife habitats in the future.

This work is supported by federal State Wildlife Grants, the federal Pittman-Robertson Funds program, and state revenues from the Loon Conservation Plate and Chickadee Check-off Funds.

--Don Katnik



BIRD GROUP

The breadth of the Bird Group's programmatic responsibilities involve stewardship of 223 bird species that nest in Maine and many more that migrate through or winter in Maine. Several of Maine's birds occur statewide, but others occur only in portions of the state. Maine has a very diverse landscape and, consequently, a myriad of habitats suitable for various bird species. At least 29 inland species of birds reach the northern limits of their breeding distribution in Maine, 28 species at their southern limits, and 2 species at their eastern limits. In addition, many of Maine's island-nesting seabirds reach their southern breeding terminus on Maine's islands, like Atlantic puffins and razorbills. The peregrine falcon and wild turkey have been reintroduced in Maine. The peregrine population is slowly increasing, and the wild turkey has expanded into areas beyond our expectations. Other species, such as the turkey vulture, blue-winged warbler, evening grosbeak, American oystercatcher, sandhill crane, and several species of wading birds have expanded their breeding range into Maine at various times over the past century.



Brad Allen, Bird Group Leader – Brad oversees group activities and budgets and currently is finishing up a common eider survival study. Brad also coordinates Department interests in seabird research and management activities which included a coast-wide gull and cormorant survey this past spring.

Erynn Call, Wildlife Biologist – Erynn is the newest member of the Bird Group and is now the Department's Raptor Specialist. Erynn has a high level of experience and training in bird research, collaborative work with others in the conservation field, writing skills, and bird surveys. Erynn is currently in the final stages of completing her Ph.D. at the University of Maine at Orono where she is monitoring the long-term responses of river birds to dam removal in the Penobscot River.

Danielle D'Auria, Wildlife Biologist – Danielle is the Department's species expert on marsh birds, wading birds, common loons, and black terns. Over the past three years, she has also devoted a great deal of effort to heron surveys and coordination of a volunteer heron monitoring program. Her other field-related duties include marsh bird surveys and research, black tern surveys, and inland seabird surveys.

Thomas Hodgman, Wildlife Biologist – Tom develops and implements programs and surveys to assess the status of songbirds in Maine and coordinates several priority bird research programs. Tom's recent focus is working with two graduate students studying saltmarsh sharp-tailed sparrows and rusty blackbirds. Tom routinely provides technical assistance and advice to the Wildlife Management Section regarding bird migration and the ever-expanding windpower development.

Kelsey Sullivan, Wildlife Biologist – Kelsey coordinates IFW's waterfowl banding programs, surveys, and research to assess the status of game bird populations in Maine. Game bird species that Kelsey is responsible for include ruffed grouse, American woodcock, wild turkeys, ducks, and Canada geese. He is Maine's representative on the Atlantic Flyway Council Technical Section.

Lindsay Tudor, Wildlife Biologist – Lindsay coordinates the Department's shorebird program with current emphasis on shorebird habitat protection under the Natural Resources Protection Act and piping plover and least tern management. Lindsay's current research involves shorebird movements within the Gulf of Maine, and her primary survey responsibilities include coastal shorebirds and harlequin ducks.

The Bird Group would like to thank the following dedicated individuals who have assisted us with our bird conservation and management tasks over the last year: Diane Winn and Marc Payne, Avian Haven; Maine Warden Service pilots: Durwood Humphrey, Charlie Later, and Dan Dufault; USFWS pilot/biologist Mark Koneff; Shannon Buckley, Kate Ruskin, Mo Correll, Kate O'Brien, Lauren Gilpatrick, Douglas Haislet, Patrick Haislet, Landon Knittweiss, John Morgan, Todd Jackson, Connor Jackson, Pete Caron, Jase Caron, Bret Caron, Bill Carle, Soren Siren, Brian Lewia, Courtney Hagenaaars, Brad Shepard, Tom Berube, Dave Hentosh, Allen Milton, Gary Milton, Glen Mittelhauser, John Drury, Dave Hiltz, Chris West, Don McDougal, Jim Dyer; Bill Hanson, Brookfield Power; Chris DeSorbo, Rick Gray, Wing Goodale, Lucas Savoy, Bruce Connery, Lesley Rowse; Joe Wiley, Bureau of Parks and Lands; Margo Knight, Don Mairs, Ron Joseph, Patrick Keenan, Bill Johnson, Bill Sheehan, Thomas Cochran; Susan Gallo, Maine Audubon; Don Reimer, Scott Kenniston, Dick Hutchinson, Libby Mojica, John Sewell, Sharon Fiedler, Ed Friedman, many Heron Observation Network volunteers, many River Bird Project volunteers, many private landowners who have granted us access to their property for surveys and monitoring, and IFW regional staff.

BIRD CONSERVATION AND MANAGEMENT

New Avenues for Bird Conservation Funding and Data Collection

Get “Banded” with the Maine Birder Band

Funding nongame programs is perpetually a concern of our Department. About 90% of Maine’s 292 bird species fall into this category. Five years ago, IFW launched the Maine Birder Band program through which individuals can donate to a fund dedicated to bird conservation in Maine. In exchange for a \$20 donation, contributors get “banded” and receive a bird band with a unique identifying number that is registered with our Department. The bird band is the size of a band used to tag a Canada goose or wild turkey and is meant to fit onto a binocular or camera strap. If the band is lost, the finder can call IFW to reunite the band and the item to which it is attached to its rightful owner. To date, nearly 1,000 bands have been sold to individuals in 27 states or provinces, generating approximately \$20,000 in revenue that will go directly to bird conservation efforts in Maine, including research and monitoring. As a non-federal source of funding, Maine Birder Band funds are in reality worth even more. They can be used as a match to federal funding sources, such as the USFWS’ State Wildlife Grant program and leverage up to three times their worth.

Some of the projects that have been partially funded by Maine Birder Bands include:

- Launch and maintenance of the Maine eBird Portal (which leveraged an additional \$2,500)
- Grasshopper sparrow survey at Kennebunk Plains and the former Brunswick Naval Air Station (which leveraged an additional \$975)
- Research examining saltmarsh sparrow nesting success in sites with and without tidal restrictions (which leveraged an additional \$11,550)
- Southern Maine shorebird monitoring focused on sanderlings, red knots, black-bellied plovers, and ruddy turnstones (which leveraged an additional \$2,500)

In addition to the lasting benefits that the Maine Birder Band can provide to IFW’s bird conservation efforts, it has also helped a few individuals locate their lost binoculars and even a set of lost keys!



Birders Contribute through the Maine eBird Portal

Web-based applications that allow amateur naturalists to record field sightings are rapidly growing in popularity and are helping to reconnect the on-line community with the natural world. Cornell University’s eBird application was one of the first websites that allowed birders of all expertise to enter their sightings into a map-based database and contribute directly to scientific understanding of bird populations and species distributions. In 2011, Maine joined other New England states in launching a state-specific eBird portal. Maine’s site is one of four in the country that is supported by the State wildlife agency. As a result, IFW acts as the website administrator and controls the interface that hundreds of birders currently use daily to submit bird-sightings data. eBird provides direct access to birders’ observations and enhances IFW’s ability to monitor species and develop conservation programs throughout the state. In 2012, over 24,000 individual bird checklists representing data for 408 species were submitted by birders, compared to only half as many checklists in 2010, the year prior to the launch of the Maine eBird Portal.

Maine eBird offers a variety of functions allowing users to submit and explore data. The primary functions include:

- Birding News and Features: provides users with information regarding MDIFW activities, birding events, and rare species sightings.
- Submit Observations: uses a Google maps application to create a birding location to record associated bird sightings.
- Explore Data: allows user to search maps for specific species, discover recent rare bird sightings, and track seasonal movements of birds.
- My eBird: once registered as a user, eBird stores all records on a “My eBird” page so that users can review sightings, maintain an online “life list,” and receive species alerts.

The data are currently in use by IFW, helping us to better inform conservation planning efforts for the following avian Species of Greatest Conservation Need identified in Maine’s Wildlife Action Plan:

- Barrow’s goldeneye: eBird data used to pick up sightings missed by survey efforts, and to understand distribution and abundance in neighboring states.
- American kestrel: eBird data used to look at statewide distribution and habitat use.
- Shorebirds: volunteer shorebird surveys (ISS/PRISM and Enhanced monitoring program) are being entered through eBird.
- Red knot: eBird data used to identify all records of occurrence and to identify most important areas.

The Maine eBird site can be accessed directly from IFW’s home page: www.maine.gov/ifw/. As the popularity of Maine eBird grows, we expect that the awareness of and support for our nongame conservation work will also expand among Maine birders.

Sale of HERON Sticker to Fuel 2015 Aerial Survey

IFW’s Heron Observation Network of Maine (HERON) has partnered with Burly Bird (a Maine-based conservation sticker company) to help raise funds for an important statewide aerial survey for nesting great blue herons scheduled for 2015.

Members of the public can support HERON in its efforts by purchasing a UV-coated vinyl sticker that shows a black and white silhouette of a great blue heron. The HERON sticker can be placed anywhere, including on car bumpers and windows, house windows to help prevent bird-to-glass collisions, water bottles, coffee mugs, laptops, or bikes. HERON is a volunteer adopt-a-colony program started by IFW in 2009 in order to gain a better understanding of the great blue heron's status within Maine. In addition to the data collected by volunteers, it is important to periodically do a statewide aerial survey to find new heron colonies that may have recently popped up.

The stickers can now be purchased for \$4 each through IFW's online store (www.mefishwildlife.com) or from the Burly Bird website (www.burlybird.com). Seventy-five percent of the proceeds will go directly to heron research and monitoring in Maine, and will help leverage additional federal funding through Maine's State Wildlife Grant program.

For more information about the Heron Observation Network of Maine, visit www.maineheron.wordpress.com, or contact Danielle D'Auria at danielle.dauria@maine.gov or (207) 941-4478.

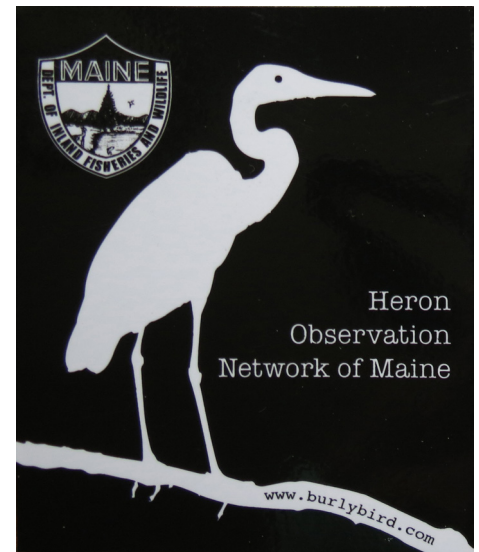

Financial support for this work was provided by the federal State Wildlife Grants program and state revenues from the Loon Conservation late and Chickadee Check-off funds.

--Danielle D'Auria

Habitat Selection and Nest Predation of Rusty Blackbirds in Maine's Working Forest

The rusty blackbird (*Euphagus carolinus*) is a wetland breeding songbird of the northern forest. They occupy small wetlands and flowages that provide shallow water for foraging and dense conifers nearby for nesting. Rusty blackbirds are considered a species of high conservation concern (Special Concern in Maine), as the population has plummeted by an estimated 80–90% in the last 50 years. IFW partnered with a student at SUNY College of Environmental Science and Forestry to study nest habitat selection and nest predation of rusty blackbirds at multiple spatial scales, and examine how these processes might be influenced by forest management in northern Maine.

Previous work in Maine indicated that this species may be suffering from an “ecological trap,” where they preferentially nest in regenerating clear cuts, but experience higher nest predation and lower nest success in these habitats compared to uncut areas. Although red squirrels were the primary suspect, the specific predator species responsible for depredating rusty blackbird nests remained unknown.

To better understand why rusty blackbirds have failed to recover from their long decline and what management actions might aid conservation efforts, we chose to: 1) determine which species are the primary predators on rusty blackbird eggs and nestlings; 2) examine nest habitat selection at multiple spatial scales; 3) relate nest success to habitat features at multiple spatial scales; and 4) identify potential linkages between predation, habitat, and cone cycles.

During May and June of 2011 and 2012, we conducted call/response surveys for rusty blackbirds using an adult call that we broadcast from a handheld mp3 player at wetlands throughout the Moosehead Lake region. We located a total of 26 rusty blackbird nests and monitored 21 of these with passive infrared-triggered cameras. We also made repeat visits to nests to monitor nestling survival and development. After the nesting cycle was complete, we measured vegetation and habitat characteristics around each nest, as well as in nearby control plots. To measure squirrel abundance, we conducted call/response surveys at both nest locations and in select mature softwood stands.

Habitat Selection

At the larger home-range scale, percent cover of wetlands and percent cover of young softwoods was most-closely associated with presence of rusty blackbirds. At the smaller “nest-patch” scale, the amount of small conifers and canopy cover around the nest were important habitat features. Density of small softwoods had a positive effect on probability of selection, while canopy cover had a negative effect, indicating that birds preferred locations with short, dense conifers and a lack of tall trees.

Nest Predators and Nest Survival

We documented eight predation events on camera (2 in 2011, 6 in 2012), and identified four species of nest predators: red squirrel, white-tailed deer, an accipiter (i.e., sharp-shinned or Cooper's hawk), and blue jay. Red squirrels were the most frequent predator observed at rusty blackbird nests, but only in 2012, accounting for 66% of all recorded predation events that year.

Both the spruce-fir cone crop and the red squirrel population changed significantly during our study. Cones were much more abundant in 2011, relative to 2012. Squirrel detections were relatively scarce in 2011, but increased significantly in 2012. Patterns of rusty blackbird nest survival reflected this increase in the squirrel population. In 2011, the year with low squirrel abundance, nest success was 59%. In 2012, when squirrels were abundant, nest success plummeted to 30%. Overall rusty blackbird nest success (including all sites and both years) was 47% which is consistent with other recent studies in Maine and Alaska.

At the home-range scale, nest survival was most influenced by year (i.e., high vs. low squirrel abundance) and distance to road. Nest survival increased with increasing distance to a road in 2011, but not in 2012. In the absence of squirrels, edge-associated species may be important predators of rusty blackbird nests.

Nest survival at the nest-patch scale was best predicted by total basal area, suggesting that an increase in vegetation density around the nest increased nest survival. Harvest history of the nest-patch was not an important predictor of nest survival, and nests in regenerating clearcuts experienced similar nest predation rates relative to nests in unharvested stands.

In conclusion, we found that young softwoods were an important influence on habitat selection at all spatial scales. Almost 90% of nests were in harvested stands, and nest survival did not appear to be lower in harvested habitats. Despite the challenges associated with camera monitoring in forested habitat, we successfully photographed eight predation events. Red squirrels were the primary nest predators, but only in 2012 after an abundant cone crop in 2011. Nest predation was much higher in 2012, suggesting that fluctuating predator populations in response to cone cycles is driving nest predation rates in rusty blackbirds in the Moosehead Region.

Financial support was provided by the federal State Wildlife Grants program, as well as the Loon Conservation Plate, Chickadee Checkoff Fund, Maine Outdoor Heritage Fund, Garden Club of North America, The State University of New York – College of Environmental Science and Forestry, and the Edna B. Sussman Fund.

--Thomas Hodgman

IFW's Raptor Program Takes a New Turn

I feel fortunate to follow in the footsteps of Charlie Todd, who after nearly 40 years of focusing his efforts on Maine's bald eagle population, accepted the Endangered and Threatened Species Coordinator position within our Department. Charlie's encyclopedic knowledge and devotion to the recovery of this raptor is an example for other biologists, like me, that one person can make a difference. I hope to apply what I learn from Charlie's experiences, and the knowledge I've acquired in my career, to guide future raptor research.

River Raptors

My current research focuses on river-associated birds, including bald eagles and ospreys, and will likely shape some of the topics I pursue in this position. Rivers represent a valuable resource to Maine's citizens and wildlife, and they are forever challenged by issues associated with water quality, land development, and dams. Birds are tightly linked to the river, as they feed at multiple levels of the food chain and thus are a good way to track change in this system. Dramatic declines in anadromous fishes may have led to shifts in nesting locations and foraging behavior of fish-eating raptors with ramifications rippling all the way to seabird nesting islands. With fewer fishes, competition between eagles and osprey intensify, with the latter getting pushed off to nest further away from the river. With fewer fish on the menu, bald eagles now appear to have a greater appetite for birds. Seabirds, such as great cormorants and common eiders, now receive frequent and unwanted eagle visits on the nesting islands resulting in their direct or stress-induced mortality.

I hope to work with regional biologists, non-profits, and universities to develop a research program that demonstrates the importance of anadromous fishes to raptors, with an emphasis on alewives. These data will support the need to focus management efforts on improving fish passage, pursuing dam removal, and promoting land stewardship of riparian habitat. I also will continue to coordinate the Maine River Bird Project, which focuses on all bird species (including raptors) that rely on the river at some point in their life cycle.

American Kestrel

While not listed in Maine, American kestrel populations have been on the decline across North America, with the Northeast experiencing an 88% drop since 1966. One of the contributing factors may be associated with the loss of nest cavities after Dutch Elm disease eliminated old trees with these amenities. The availability of fewer nesting sites may cause an increase in competition with another cavity-nester, the European starling. Loss of large (> 250 ha) agricultural and open field habitat patches, an increase in kestrel predators, such as the Cooper's hawk, and the presence of environmental toxins are also likely contributors to their decline.



Photo Credit: Sharon Fiedler

The American Kestrel Partnership is a research and conservation project designed to investigate the causes of their population decline and devoted to improving the kestrel's plight. It is my goal to tie into this effort in Maine and to further examine the causes of kestrel decline and pursue monitoring efforts that will involve the expertise of fellow biologists, universities, falconers, birders, non-profits, and interested members of the public.

This work is supported by the federal State Wildlife Grants program and state revenues from the Loon Conservation Plate and Chickadee Check-off Funds.

--Erynn Call



Photo Credit: Paul Cyr

Game Birds

Migratory Game Birds

IFW collaborates with USFWS in assessing migratory game bird populations and harvests. To assess populations, several surveys are conducted throughout the year that target specific migratory bird species groups such as sea ducks and dabbling ducks. Following each migratory bird hunting season, harvest is measured using: 1) the Harvest Information Program (HIP), with data on total estimated harvest, an estimate of the number of active hunters, and the estimated number of days afield; 2) the Wing-collection Survey, where hunters contribute one wing from each harvested bird (this serves as a measure of productivity from the past spring); and, 3) analysis of band recoveries from numbered metal bands placed on birds prior to the fall hunting season that provide estimates of harvest rates and overall survivorship of a species.

American Woodcock

American woodcock are managed on the basis of two regions or populations, referred to as the Eastern and Central Regions. These woodcock populations are basically located east and west of the Appalachian Mountains. Maine is one of the most important states for breeding woodcock within the Eastern Management Region.

Each spring, beginning in 1968, a coordinated survey called the Singing-ground Survey (SGS) is conducted in all states with woodcock populations. Each survey participant records the number of singing male woodcock they hear in the spring along specific routes distributed throughout Maine. Forty-five routes were conducted in Maine in 2013 by IFW staff, USFWS staff, and a number of volunteers. The long-term trend (1968 to 2013) indicates an overall decline in American woodcock numbers across their range; however 2013 is the tenth year in a row that the population in the east appears unchanged, based on survey results. This long-term decline is believed to be caused by an overall loss in woodcock habitat in the east. In 2013, the average number of males heard on Maine's SGS routes was 3.74; these data are preliminary. Last year, the average number of males heard on Maine survey routes was 3.77. The 10-year average is 3.75 males/route.



Woodcock hunting season

Based on data from HIP, approximately 3,400 woodcock hunters harvested an estimated 9,600 woodcock in Maine in 2012. This was a decrease in harvest compared to the previous year. The recruitment index of 1.6 immature (young of the year) to one adult female in the 2012 harvest was close to the long-term average of 1.7 young/adult female (1963–2012). The recruitment index is a measure of the ratio of immature woodcock per adult female derived from the Wing-collection Survey described above. Maine hunters provided 1,296 woodcock wings from the 2012 hunting season for that survey.

Waterfowl

Waterfowl harvest metrics are also derived from the Harvest Information Program. Harvest estimates for the 2005 to 2012 waterfowl seasons are listed below in Table 2.

Table 2. Maine Waterfowl Harvest 2005-2012.

Species	2005	2006	2007	2008	2009	2010	2011	2012
American Black Duck	7,623	5,387	5,000	4,683	5,364	3,377	2,133	3,300
Mallard	16,855	12,231	12,700	11,265	12,711	8,379	7,441	14,000
Green-Winged Teal	3,077	4,309	6,100	7,872	4,923	3,189	2,042	2,300
Wood Duck	6,224	5,577	5,400	3,461	7,641	8,567	5,989	6,700
Ring-necked Duck	699	1,300	300	747	1,763	1,688	454	600
Common Goldeneye	3,777	2,091	1,600	2,307	1,469	313	318	600
Total (all regular ducks included)	38,255	29,895	31,100	30,335	33,871	39,100	31,500	39,900
Canada Goose	7,826	9,800	9,100	13,800	4,700	9,194	3,717	9,500
Sea Ducks								
Common Eider	10,842	18,133	13,100	11,143	4,355	4,505	6,400	5,200
Long-tailed Duck	690	1,779	1,000	4,305	656	2,321	2,695	No Data
Scoter	2,168	2,288	1,700	4,052	890	1,092	674	3,200
Total Sea Duck Harvest	13,700	22,200	15,800	19,500	5,901	7,918	9,769	8,400
Total Waterfowl Harvest	59,781	61,895	56,000	63,635	44,472	42,625	44,986	57,800

Resident Game Birds

Wild turkeys and ruffed grouse are two species of game birds that spend their annual life cycle within the State of Maine. For this reason, all management authority and responsibility remain within IFW.

Wild Turkey

The spring wild turkey hunting season is the season of choice for the majority of turkey hunters. During the spring, male turkeys are particularly responsive to hunters' calls. Although spring wild turkey hunting license sales have declined somewhat in recent years, the harvest success rate remains high at over 30%. Interest in fall turkey hunting remains somewhat low in Maine, and fall harvests remain low. Noteworthy was the harvest spike in 2007 when IFW established a week-long shotgun season in addition to the bow hunting season, in certain WMDs (Table 3).

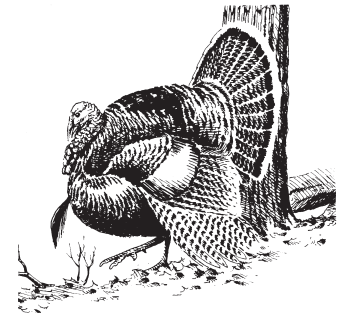

Table 3. Wild Turkey Spring (2000-2012) and Fall (2002-2012) Registered Harvests.

Season	2000	2001	2002	2003	2004	2005	2006	2007	2008	2009	2010	2011	2012
Spring	1,559	2,544	3,391	3,994	4,839	6,236	5,931	5,984	6,348	6,043	6,077	5,445	6,079
Fall	NA	NA	151	246	204	157	198	1,843	685	712	1,205	667	958

The 2013 spring wild turkey hunting season marked the fourth year that hunters could purchase a combination spring/fall wild turkey hunting permit. This permit allows the holder to take one bearded bird in the spring and one bird of either sex in the fall. Hunters may choose to take an additional bearded bird in the spring if they purchase a second tag. Youth hunters with a valid junior hunting permit are not required to purchase a separate wild turkey hunting permit. The spring 2012 turkey harvest of 6,079 was higher than the 2011 harvest of 5,445. In addition, the 2012 spring harvest resulted in 826 hunters registering two birds. While the results are preliminary, it appears that hunters in the spring 2013 turkey season registered over 6,000 birds again. Hunters should be aware of pending rule changes for turkeys; if this happens there will be a press release with more information on our website.

Ruffed Grouse

Beginning in 1994, moose hunters are asked to report the number of grouse (partridge) they and their party see or shoot during the moose hunting season. Data are compiled by geographic region, and MDIFW calculates the number of grouse seen per 100 hours of moose hunting effort (Table 4). Based on survey results and hunter reports, the northwest region again continues to have excellent grouse numbers. Be sure to check the 2013-14 Hunting Laws and Rules booklet for a new labeling requirement that could affect you while hunting grouse and staying in an unorganized township.

Table 4. Grouse Seen or Harvested/100 hours of Moose Hunter Effort in Maine for the last 15 years (1998-2012).

Location	1998	1999	2000	2001	2002	2003	2004	2005	2006	2007	2008	2009	2010	2011	2012
Northeast	42	41	30	53	23	35	27	11	26	37	31	48	47	59	44
Northwest	48	47	50	55	43	50	56	24	45	44	51	101	101	81	93
Eastern Lowlands	27	30	25	55	29	29	24	8	20	53	23	34	34	30	34
West & Mountains	41	29	28	30	25	26	30	13	25	44	19	36	36	32	50
Downeast	-	-	-	-	13	21	20	9	22	19	28	30	29	15	13
Statewide	43	37	33	48	31	34	33	13	24	39	27	47	46	43	42

This work is supported by the federal Pittman-Robertson Fund, revenue from the sales of hunting licenses, and from volunteer assistance.

--Kelsey Sullivan

Researchers Investigate Common Eider Survival Rates

Bird Group Leader Brad Allen, working with colleagues Dan McAuley-USGS and Guthrie Zimmerman-USFWS are interested in comparing current common eider (*Somateria mollissima dresseri*) survival rates with those reported in the 1990s. A lot has changed since eider numbers peaked along the Maine coast in the late 1980s.

Population growth of long-lived species that delay maturity, such as the common eider, is highly sensitive to alteration in adult survival. Eiders in the northeastern United States and eastern Canada are the most-hunted sea duck on the east coast of North America. Consequently, over-harvest is a concern and may be responsible for reduced abundance that is evident today.

Banding efforts for common eiders in the northeast have not been constant over time. Until recently, survival and recovery rates had only been available for adult females, and there was a need for information on the other sex-age classes. During the 1970s to mid-1980s there was an effort to band female eiders nesting on islands in Maine. Numbers of adult females banded per year ranged from 120 to 609. Since then, but prior to this investigation, 0–50 females have been banded each year. Other researchers analyzed banding data for the Atlantic coast population of common eiders but only had sufficient data for the years 1976–1986. For this population they found recovery rates were low (1%) and annual survival was high (87%). Maine female eider survival rates were a bit higher at 90%. Because 1) these estimates are more than 25 years-old and are only for adult females, 2) harvests of eiders were increasing, and 3) recruitment rate (the production of young) is declining, there was a need to obtain better estimates of survival and recovery rates for the current eider population. Further, we developed a technique to capture a significant number of molting male eiders at two coastal island sites. We have never been able to estimate survival rates of male eiders until this study. Survival and recovery of eiders were determined by using band recovery data. Similarly, using recapture procedures designed by Jolly-Seber Models, we recorded live recaptures of nesting female eiders to generate a second survival estimate.

Our results indicate that female survival rates have not changed since the earlier study (1986 = 90%; 2012 = 89%). Adult female survival rates may be functionally fixed and at present, adult survival may be relatively unresponsive to environmental or management perturbations. Hunting pressure and harvests have changed considerably over the time frame of these two investigations. In addition, the population has declined from the apparent high number of nesting females in the late 1980s. These results indicate that the cause of this population decline is more than just adult mortality and may be exacerbated by very poor recruitment of young-of-the-year eiders. This needs further study.

Male eider survival rates were lower than that of females, at 84%. One significant mortality factor for eiders is hunting mortality. Harvest of common eiders in the eastern U.S. is male biased at 2.24 males per female. The sex ratio of harvested eiders in the U.S. between 1984 and 1996 was 1.64 and the sex ratio from 1997 to 2010 was 2.33. The sex ratio of the overall adult common eider population appears to be near 50:50 based on annual observations taken during the Midwinter Waterfowl Survey. This male harvest bias is likely due to hunter selectivity for males and may partially explain the lower male survival rate.

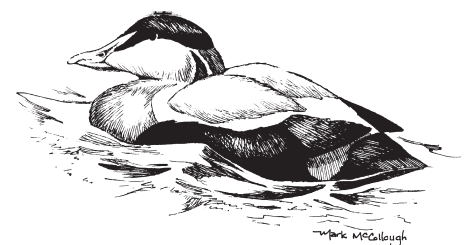

This work is supported by the federal Pittman-Robertson Funds program and revenue from the sales of hunting licenses.

--Brad Allen

MAMMAL GROUP

The Mammal Group is one of 5 groups in the Research and Assessment Section (RAS) in the Bangor Office. We develop and oversee the implementation of all management systems for Maine's mammals, conduct surveys, and collect a variety of biological information. We address public and departmental informational needs through the development of research programs, monitoring protocols, species assessments, and public presentations. Finally, we assist in the formulation of harvest regulations by analyzing biological data, meeting with regional biologists in the Wildlife Management Section, and by making harvest recommendations to the Wildlife Division Director.



Wally Jakubas, Ph.D., Mammal Group Leader – Supervises mammal group personnel, oversees all group activities, writes grant proposals, manages the group's budgets, serves as the lead biologist for New England cottontail, represents the Department on the technical and executive committees for the Regional New England Cottontail Initiative, and is an external member of the graduate faculties for the University of Maine and University of New Hampshire. Wally is the departmental spokesperson on New England cottontail, wolf, and cougar issues.

Randy Cross, Wildlife Biologist – Supervises bear field crews in radiocollaring bears and collecting biological information, assists in analyzing bear data, oversees the processing and aging of moose, deer, and bear teeth, and gives numerous talks to the public during bear den visits. Randy is a highly experienced field biologist who has worked for the Department for over 30 years. During this time, he has shared his enthusiasm and knowledge of bears and bear management with many students, legislators, and members of the general public.

John DePue, Wildlife Biologist – Oversees the management of furbearers and small mammals. John reviews and proposes changes to Maine's trapping regulations, designs small mammal and furbearer surveys, writes grant proposals, monitors white-nose syndrome in bats, assesses the impact windpower projects have on mammals, and serves as departmental spokesperson on furbearer and small mammal issues. John is one of the principal responders for releasing lynx that have been incidentally trapped. He is currently collaborating on marten research with the University of Maine Cooperative Unit, and with Maine Audubon on monitoring Maine's bat populations.

Lee Kantar, Wildlife Biologist – Oversees the management of Maine's moose population – the largest moose population in any state south of our Canadian neighbors. Lee's work includes developing and conducting aerial surveys, collecting biological data, leading a team of biologists in making annual recommendations on moose hunting permits, organizing IFW's monitoring effort for chronic wasting disease, writing grant proposals, and serving as departmental spokesperson on moose issues. Lee is interested in the diseases and parasites that affect moose and deer and is the Department's representative on the new Northeast Wildlife Disease Cooperative.

Kyle Ravana, Wildlife Biologist – Oversees the management of Maine's white-tailed deer population. This is Kyle's first year as Maine's Deer Biologist. Kyle is taking a fresh look at our data collection methods, investigating new population models for deer management, and is becoming familiar with the staff and habitats in each of IFW's management regions. Kyle works closely with a team of regional biologists in making annual recommendations on the allocation of Any-deer permits, collects biological data on deer, assists in conducting deer population surveys, and serves as the departmental spokesperson on white-tailed deer issues.

Jennifer Vashon, Wildlife Biologist – Oversees the management of black bear and lynx. Jen collects and analyzes biological data, writes grant proposals, makes annual recommendations for harvesting black bears, provides technical support on nuisance bear issues, and is the departmental spokesperson on lynx and bear issues. Jen oversees the Department's efforts to release lynx that are incidentally caught by trappers and is the primary responder to these captures.

2012-13 Contract Workers & Volunteers – Bat Project: Lisa McKinney, Dana Johnson; **Bear Project:** Phillip Adams, Christina Basnar, Lisa Bates, Jake Feener, Mitch Jackson, Dan Wagner, John Wood; **Deer Project:** Holly Bates, Lisa Bates, Philip Dumond, Wendall Harvey, Eldon McLean, Matt O'Neal, Kyle Ravana; **Lynx Project:** Lisa Bates; **Moose Project:** Lisa Bates, Scott Belair, Tracie Bellinger, Nicole Bellerose, Darryl Ann Girardin, Kyle Ravana, Joe Roy, John Wood; **New England cottontail Project:** Tom Esson, Toni Mikula.

We deeply appreciate the dedication and hard work we receive from our contract workers and volunteers!

MAMMAL CONSERVATION AND MANAGEMENT

White-tailed Deer

2012 Deer Harvest

Season Dates and Structure

Maine Deer hunters could hunt white-tailed deer for 79 days within the structure of five different hunting seasons during 2012; expanded and regular (October) archery, rifle, muzzleloader, and youth day.

2012 Doe Quotas, Any-Deer Permits, and Applicants

The Department distributed 34,160 Any-deer Permits amongst 13 WMDs in order to meet its doe harvest objective of 4,398 does in 2012. Because the doe harvest is not a one-to-one relationship with the number of permits issued, the state applies an expansion factor to its doe quotas at the WMD level resulting in more permits issued than does expected to be harvested. As such, 2012 permit allocations ranged from zero in 17 WMDs (1-11, 14, 18, 19, 27, and 28), to 7,659 permits in WMD 21. The top 5 WMDs receiving Any-deer Permits on a per 100 mi² basis were WMD 21 (1,591 permits),

WMD 24 (1,118 permits), WMD 20 (1,042 permits), WMD 22 (473 permits), and WMD 23 (442 permits). Maine residents drew 23,519 permits (68%), landowners (comprised of residents and non-residents) drew 8,543 permits (25%), nonresidents drew 1,656 Any-deer Permits (4%), and Superpack permittees won 442 permits (1%). Overall, 67,632 people applied for Any-deer Permits for the 2012 hunting season (62,954

Table 5. Statewide sex and age composition of the 2012 deer harvest in Maine by season type and week. Records were corrected and/or adjusted to account for registration errors.

Season	Sex/Age Class				Total Deer	Total Antlerless Deer	Percent by Season and Week		
	Adult		Fawn				Total	Buck	Antlerless
	Buck	Doe	Buck	Doe					
Archery	744	864	137	168	1,913	1,169	9%	5%	19%
Expanded	537	728	114	145	1,524	987	7%	3%	16%
October	207	136	23	23	389	182	2%	1%	3%
Youth Day	226	225	60	59	570	344	3%	1%	6%
Regular Firearms	13,799	2,972	714	586	18,071	4,272	84%	90%	70%
Opening Saturday	1,352	330	81	70	1,833	481	9%	9%	8%
Oct 29-Nov 3	3,092	703	175	145	4,115	1,023	19%	20%	17%
November 5-10	3,210	646	157	122	4,135	925	19%	21%	15%
November 12-17	3,011	496	124	98	3,729	718	17%	20%	12%
November 19-24	3,134	797	177	151	4,259	1,125	20%	20%	18%
Muzzleloader	604	226	47	40	917	313	4%	4%	5%
Nov 26-Dec 1	392	92	22	17	523	131	2%	3%	2%
December 3-8	212	134	25	23	394	182	2%	1%	3%
Crossbow ¹	12	15	5		32	20			
Unknown					82				
Total	15,385	4,302	963	853	21,553	6,118	100%	100%	100%

¹ Deer taken by crossbow were taken by special allowance during the expanded archery, archery, and/or the regular firearms seasons.

residents 8,736 landowners; 4,678 nonresidents and 1,535 Superpack; Superpack were all counted as part of resident applicants).

Statewide Statistics for 2012

21,553 deer were registered during the 2012 hunting season, of which 1,524, 389, 570, 18,071, and 917 were taken during the expanded archery and regular archery, youth day, regular firearms, and muzzleloader seasons, respectively (Table 5). There were 2,713 more deer harvested in 2012 than in 2011, representing a 14% increase over the 2011 hunting season.

Buck Harvest

The 2012 statewide harvest of 15,385 antlered bucks is a 23% increase from the 2011 hunting season,

Table 6. Sex and age composition of the 2012 deer harvest in Maine by Wildlife Management District¹.

Wildlife Management District	Sex/Age Class				Total Deer	Total Antlerless Deer	Harvest Per 100 Adult Bucks		Harvest Per 100 Sq. Miles Habitat		
	Adult		Fawn				All Deer	All Adult Bucks	All Miles Habitat		
	Buck	Doe	Buck	Doe							
1	138	0	0	0	0	138	0	10	10	0	
2	107	0	0	0	0	107	0	9	9	0	
3	200	0	3	0	3	203	0	23	23	0	
4	139	0	0	0	0	139	0	7	7	0	
5	176	1	0	0	1	177	1	12	12	0	
6	341	2	2	0	4	345	1	24	24	0	
7	400	13	7	3	23	423	3	29	30	1	
8	283	3	4	0	7	290	1	14	15	0	
9	115	0	0	0	0	115	0	13	13	0	
10	88	1	4	0	5	93	1	9	10	0	
11	303	2	4	0	6	309	1	18	19	0	
12	519	48	18	12	78	597	9	57	65	5	
13	397	68	17	16	101	498	17	70	88	12	
14	313	6	5	2	13	326	2	43	44	1	
15	1,024	390	85	75	550	1,574	38	110	169	42	
16	974	368	91	76	535	1,509	38	126	195	48	
17	1,878	491	98	89	678	2,556	26	140	191	37	
18	277	8	7	4	19	296	3	22	24	1	
19	118	0	0	0	0	118	0	10	10	0	
20	1,124	577	113	117	807	1,931	51	194	333	99	
21	1,018	624	127	123	874	1,892	61	211	393	130	
22	786	235	56	43	334	1,120	30	181	259	54	
23	1,246	381	100	83	564	1,810	31	160	232	49	
24	493	326	55	57	438	931	66	225	425	149	
25	916	227	44	40	311	1,227	25	130	175	32	
26	1,109	246	45	47	338	1,447	22	123	161	27	
27	369	2	5	0	7	376	1	50	51	0	
28	220	3	1	0	4	224	1	20	21	0	
29	404	265	54	58	377	781	66	278	538	182	
Statewide	15,475	4,287	945	845	6,077	21,552	28	39	54	75	15

¹Sex/age data were corrected for errors in the deer registrations

in which hunters registered 12,862 adult bucks (Table 6). Indeed, the 2012 season resulted in the number of bucks harvested per 100mi² of habitat often exceeding the 10-year average across WMDs (Figure 1). Excluding WMD 29, the top 5 buck-producing (per mi² basis) WMDs in 2012 were (in descending order), districts 24, 21, 20, 22, and 23. Among antlered bucks taken in 2012, approximately 7,846 (51% of harvested adult bucks) were 1½ year-old deer sporting their first set of antlers. Maine experienced a reduction in the frequency of yearling males in the harvest by approximately 3% from 2011.

A higher buck harvest in 2012, coupled with fewer yearling bucks represented in the harvest, indicates an increased harvest of older more mature animals. Yearling male frequency (YMF) is also used as an estimate of annual all-cause buck mortality (i.e., hunting mortality, road-kill, natural mortality, etc.). The relatively low YMF in Maine indicates that the state's deer population should have a relatively healthy age structure.

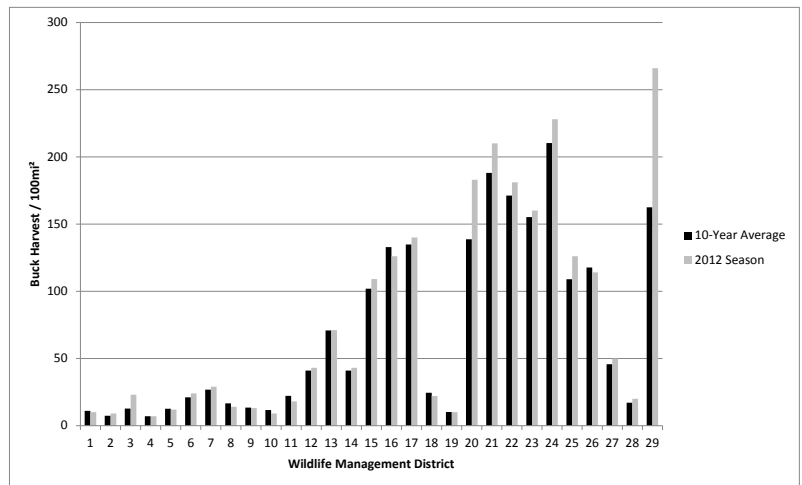

Figure 1. Following the winters of 2007-08 and 2008-09, Maine's deer population experienced a precipitous decline, however, as can be seen, buck harvests are now generally at or above the state's 10-year average.

Table 7. Statewide deer registrations, in Maine, by season type and residence.

Season and Week	Residents	Nonresidents	Total	Percent by Residents
Archery	1,790	59	1,849	97%
Expanded	1,433	43	1,476	97%
October	357	16	373	96%
Youth Day	561	9	570	98%
Regular Firearms	16,490	1,580	18,070	91%
Opening Saturday	1,833		1,833	100%
Oct 29-Nov 3	3,818	297	4,115	93%
November 5-10	3,712	422	4,134	90%
November 12-17	3,221	508	3,729	86%
November 19-24	3,906	353	4,259	92%
Muzzleloader	880	37	917	96%
Nov 26-Dec 1	491	32	523	94%
December 3-8	389	5	394	99%
Unknown ¹			147	
Total	19,721	1,685	21,553	

¹ Missing records due to incomplete information

more than 11%. Youth day took place on Saturday, October 20th, resulting in the harvest of 226 adult bucks, and 344 antlerless deer. Overall, Maine's youth experienced an increase in their deer harvest by approximately 6% over the 2011 hunting season. Due to the impacts from the severe winters of 2007-08 and 2008-09, youth hunters remained relegated to bucks-only hunting within buck-only WMDs but maintained either-sex opportunity in WMDs where Any-deer Permits were allocated.

Harvest by Hunter Residency

Residents tagged 92% of the total harvest during 2012 (Table 7). Among seasons, the proportion of the harvest registered by Maine residents was highest for archery (97%) and youth day (98%), followed by muzzleloader (96%), and firearms (91%). Regional differences occurred in the distribution of the harvest by residents and visitors to Maine (Table 8). In the more populous central

Antlerless Deer Harvest

The statewide harvest of adult (yearling and older) does during 2012 was 4,287 individuals, bringing the harvest to within 2.5% of the Department's projected doe harvest of approximately 4,398 animals, excluding WMD 29. During 2012, Any-deer permittees also tagged 1,790 fawns, while archers and youth day hunters tagged 305 young of the year. Overall, 6,077 antlerless deer were registered by hunters during the 2012 season.

Harvest by Season and Week

Approximately 84% of the total deer harvest occurred during the 4-week firearms season (Table 5). Total archery harvest remained virtually unchanged from 2011, while the muzzleloader harvest increased by slightly

Table 8. Deer registrations by hunter residence and county of kill in Maine, during the 2012 hunting season.

County of Kill	County Residents	Resident Transient ¹	Nonresidents	Total	% by County Residents
Androscoggin	887	242	18	1,147	77
Aroostook	790	156	128	1,074	74
Cumberland	1,649	450	65	2,164	76
Franklin	513	197	117	827	62
Hancock	837	157	48	1,042	80
Kennebec	1,462	196	74	1,732	84
Knox	638	180	30	848	75
Lincoln	457	81	12	550	83
Oxford	1,043	352	228	1,623	64
Penobscot	1,765	312	168	2,245	79
Piscataquis	379	355	218	952	40
Sagadahoc	499	173	10	682	73
Somerset	1,202	467	268	1,937	62
Waldo	929	379	145	1,453	64
Washington	561	59	38	658	85
York	2,334	164	120	2,618	89
Statewide	15,945	3,920	1,687	21,552²	74%

¹ Non-resident transients are residents of the State of Maine who harvested a deer in a WMD in which they do not reside within

² One missing record due to incomplete registration information

and southern WMDs, most successful deer hunters were generally Maine residents (Table 9).

Hunter Participation and Success Rate

During 2012, 209,990 licenses that permit deer hunting were sold in Maine; of these greater than 12% were bought by non-residents, resulting in a slight increase over 2011 (Figure 2). Statewide hunter participation is estimated at approximately 175,000 hunters; therefore, hunter density averaged approximately six hunters per square mile of available deer habitat. The Department estimates these hunters expended an estimated 1.31 million hunter-days of effort pursuing deer, representing a decrease in overall effort of approximately 2%.

Compared to the regular firearms season, which attracted over 150,000 participants in 2012 (estimated by license sales and the Department's Hunter Effort Survey), the expanded archery and special muzzleloading seasons attract far fewer hunters. In its 16th year, the expanded archery season once again attracted nearly 10,000 participants (over 90% residents). Participation in the special muzzleloading season continues to be strong with the sale of 15,603 permits, representing a slight increase over the 2011 muzzleloading season (~3% increase).

Table 9. Deer registrations by Wildlife Management District and hunter residence, 2012.

Wildlife Management District	Residents		Resident Transient ¹		Nonresidents		Total
	Number	Percent	Number	Percent	Number	Percent	
1	10	7.2%	93	67%	35	25%	138
2	28	26.2%	56	52%	23	21%	107
3	140	69.0%	61	30%	2	1%	203
4		0.0%	79	57%	60	43%	139
5	17	9.6%	114	64%	46	26%	177
6	272	78.8%	55	16%	18	5%	345
7	11	2.6%	274	65%	138	33%	423
8	41	14.1%	136	47%	113	39%	290
9	30	26.1%	55	48%	30	26%	115
10	35	38.0%	37	40%	20	22%	92
11	154	49.8%	100	32%	55	18%	309
12	397	66.5%	136	23%	64	11%	597
13	280	56.2%	154	31%	64	13%	498
14	92	28.2%	149	46%	85	26%	326
15	1099	69.8%	329	21%	146	9%	1574
16	1136	75.3%	314	21%	59	4%	1509
17	1722	67.4%	615	24%	219	9%	2556
18	183	61.8%	81	27%	32	11%	296
19	52	44.1%	41	35%	25	21%	118
20	1578	81.7%	255	13%	98	5%	1931
21	1342	70.9%	515	27%	35	2%	1892
22	903	80.6%	201	18%	16	1%	1120
23	1206	66.6%	449	25%	155	9%	1810
24	562	60.4%	359	39%	10	1%	931
25	1053	85.8%	138	11%	36	3%	1227
26	1178	81.4%	228	16%	41	3%	1447
27	330	87.8%	39	10%	7	2%	376
28	113	50.4%	100	45%	11	5%	224
29	354	45.3%	383	49%	44	6%	781
Statewide	14,318	52%	5,546	34%	1,683	14%	21,551 ²

¹ Resident Transient residents of the state of Maine whom harvest a deer from a WMD in which they do not reside

² Two missing records due to incomplete information

Deer hunting success (based on total number of estimated hunters and registered harvest) in Maine during the regular firearms season was estimated at 14% in 2012. The success rate for hunters who drew an Any-deer Permit (range = 20%–48%) is typically higher than for hunters who were restricted to “bucks-only” during the regular firearms season (range = 7%–22%).

Prospects for the 2013 Deer Season

In 2013, the Department will again offer 5 separate deer hunting seasons in Maine. The expanded archery season will open September 7th and run through December 14th. This season is limited to WMDs 24 and 29 as well as 10 other locations, primarily in residential-suburban areas with firearms discharge ordinances. Hunters with a valid archery license may purchase multiple antlerless permits for \$12.00 each and one buck permit for \$32.00. The purpose of the expanded archery season is aimed at increasing the harvest of does and fawns in and around urban areas in order to meet population density objectives for areas that are difficult to access via the October archery and regular firearms hunting seasons. In the expanded archery zone, deer populations can only be reduced if the limited number of archers that can gain access to huntable land are each able to harvest a substantial number of deer; hence the unlimited availability of doe tags.

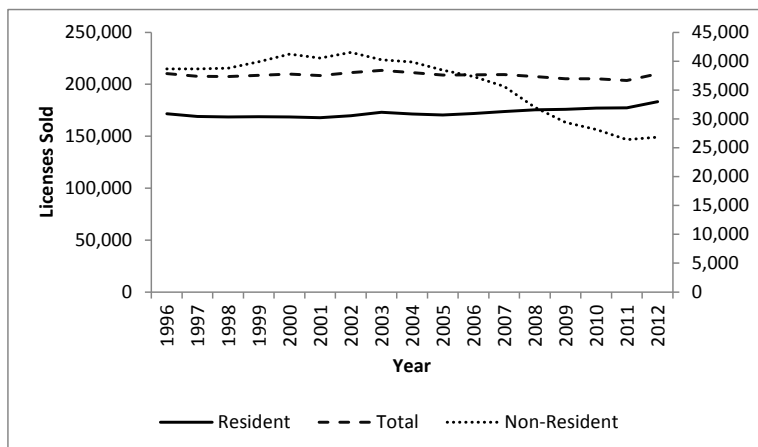

Figure 2. Until recently, Maine's sale of hunting licenses has been declining, which may be attributable to the decline in the number of non-resident hunters beginning around 2001 (right-side scale on graph). However, resident license sales have continued to increase during recent times, perhaps indicating a renewed interest in the sport (left-side scale on graph).

The regular (statewide) archery season will run from October 3rd - November 1st (25 days). Youth day will be Saturday, October 26th, and is reserved for hunters between 10 and 15 years old who are accompanied by a licensed adult. The Department asks you to

please remember that youth hunters are limited to bucks-only in WMDs that have not been allocated a doe quota by Any-deer Permits. The 25-day regular firearms season opens for Maine residents on Saturday, November 2nd, and for nonresidents the following Monday. This season ends Saturday, November 30th. Finally, the muzzleloader season will begin in all WMDs on December 2nd, but will end on December 7th (6 days) in WMDs 1–11, 14, 19, 27 and 28. Elsewhere, the muzzleloading season will continue remain open from December 9th–14th. *Crossbow archery season will coincide with modern firearms and during the archery season for special situations. Please review your Maine State Hunting Regulations, or contact your local game warden, for questions about use of crossbows.*

Availability of Any-deer Permits among our 29 WMDs is directly related to our deer management objectives. We are continuing conservative doe harvests in most eastern and northern WMDs where we are trying to increase deer densities. In contrast, does must be more heavily harvested in WMDs where current objectives are to stabilize deer abundance to 15 or 20 deer / mi². Maine's deer density goals are publicly derived goals providing a compromise between the interests of hunting and viewing opportunities, while minimizing negative impacts to the public caused by whitetails (e.g., ornamental plant and crop damage).

To accomplish deer management objectives in 2013, we have set doe harvest quotas ranging from 0 to 1,000 animals among our 29 WMDs. Totaling 5,700 does statewide, the 2013 doe quota is 32% above the doe harvest we achieved in 2012. What is more, the Department has issued doe permits in WMDs 3 and 6 for the first times since 2000 and 2007, respectively. The increased doe quota in 2013 reflects yet another mild winter working successfully with the state's recent history of lowered Any-deer Permit allocations to regrow Maine's deer population. A total of 46,710 Any-deer Permits will be issued statewide ranging from 50 permits in WMD 3 to 9,700 in WMD 20. No permits will be allocated in WMDs 1, 2, 4, 5, 8–11, 14, 18, 19, 27 and 28.

The allocation of 46,710 Any-deer Permits, along with the archery and youth seasons, should result in the statewide harvest of roughly 5,700 does and an additional 2,985 fawns in 2013. Antlered buck harvests should approximate 16,845, which is approximately a 6% increase from the 2012 buck kill of 15,835. If normal hunting conditions and hunter effort take place, the statewide deer harvest in Maine should be in the vicinity of 25,778 deer.

Disease Monitoring in Maine's Deer and Moose

Chronic Wasting Disease

Chronic Wasting Disease (CWD) is a fatal disease of the nervous system for members of the deer family, including white-tailed deer, elk, moose, and potentially caribou. The disease belongs to a family of diseases known as transmissible spongiform encephalopathies (TSEs). Other TSEs include scrapie in sheep, BSE or Mad Cow Disease in cattle, transmissible mink encephalopathy (TME) in captive mink, Feline spongiform encephalopathy (FSE) in cats, Creutzfeldt-Jakob disease (CJD) in humans, and variant CJD in humans (i.e., associated with Mad Cow Disease). Although similar in some respects, there is no known causal relationship between chronic wasting disease and any other TSE of animals or people.

CWD has been found in free-ranging deer and elk in portions of Colorado, Illinois, Kansas, Maryland, Minnesota, Missouri, Nebraska, New Mexico, New York, North Dakota, Pennsylvania, South Dakota, Texas, Utah, Virginia, West Virginia, Wisconsin, Wyoming, Alberta, and Saskatchewan. In addition, CWD has been found in captive/farmed elk or white-tailed deer herds in Colorado, Iowa, Kansas, Michigan, Minnesota, Missouri, Montana, Nebraska, New York, Oklahoma, Pennsylvania, South Dakota, Wisconsin, Alberta, and Saskatchewan. Free-ranging moose have been detected with CWD in Colorado and Wyoming.

There is no scientific evidence that CWD can be naturally transmitted to species outside the deer family, including cattle, horses, sheep, goats, or swine. There is currently no scientific evidence that CWD can infect humans. Nevertheless, public health officials recommend avoiding exposure to the CWD disease agents. In deer, CWD is caused by an abnormally-shaped protein called a CWD prion (pree-on), which causes certain other brain proteins to change to a diseased form. CWD prions then accumulate in the brain and other nervous tissues, where they physically damage affected nerve cells. Although the disease agent mainly targets nervous tissue, it occurs in most tissues of an infected animal, including muscle tissue. Infected individuals shed CWD prions in urine, feces, saliva, and eye fluids.

Chronic wasting disease is a slowly progressive disease; signs of sickness are usually not seen for 5 to 36 months after the disease agent enters the animal. Individuals showing symptoms of CWD tend to be 18 months of age or older. CWD damages the brain of infected animals, causing them to display unusual behavior, lose bodily functions, become very thin, and die within 1 to 12 months after symptoms of the illness first appear. Clinical signs identified in captive/farmed deer and elk include excessive drooling, excessive thirst, frequent urination, sluggish behavior, isolation from herd, teeth grinding, holding the head in a lowered position, and drooping ears. It should be noted that some of these symptoms can be seen after a very severe winter in Maine, when deer may appear very thin and weak. Although rare in cervids, rabies may produce some symptoms in common with CWD, such as erratic behavior and drooling.

To date, there is no evidence that CWD is present in wild white-tailed deer or moose in Maine, or in any captive member of the deer family in Maine (i.e., elk, red, sika, and fallow deer). From 2002 to 2012, MDIFW biologists have collected samples annually and have tested over 8,550 hunter-harvested deer across the state. All deer tested negative for CWD. In addition to our CWD monitoring program each year, MDIFW biologists examine 6,000 to 8,000 hunter-killed deer and 2,000 to 3,000 moose for management purposes. While conducting other fieldwork, wildlife biologists observe hundreds of live deer during a typical year. Biologists also respond to hunters who contact us when they kill apparently ill or injured individuals. To date, MDIFW biologists have not observed symptoms consistent with CWD in Maine.

No sick animals that may fit the clinical profile for CWD have ever been brought to the attention of the Department of Agriculture (DOA) or private veterinarians from among Maine's licensed deer farms. Since autumn of 2001, more than 1,900 farmed-raised elk and deer slaughtered in Maine have been tested for CWD. To date, all tests have been negative for CWD.

Winter Feeding of Deer

If supplemental feeds are free from the CWD prion, the practice of feeding deer in winter cannot cause a CWD outbreak. However, the close contact and crowding typically seen among deer at winter feeding sites can greatly accelerate the spread of infectious diseases like CWD, if an outbreak occurs from other sources. Because of the long incubation period for CWD, an outbreak among white-tailed deer at feeding sites may spread to a large area long before clinically-ill individuals are observed. This would greatly hamper efforts to control the disease. Discontinuing the practice of winter feeding of deer makes great sense as a measure to prevent the spread of CWD and other diseases. In accordance with Title 12, Section 10105, subsection 14, the Commissioner is granted the authority to regulate feeding if the feeding is deemed to be a public safety hazard, or a detriment to the deer being fed, or to minimize the risk of chronic wasting disease. MDIFW has produced an excellent video highlighting the pitfalls involved in feeding wild deer. It is available at nominal cost at our online store.

Are Urine-Based Deer Lures and Deer Feed Safe?

In most cases, the urine used to formulate commercial "doe-in-heat" or other buck lures is collected from captive deer or elk farms. If CWD prions are passed in the urine of CWD-infected deer and elk, the infective agent may be present in these lures. If present, then CWD prions may inadvertently be placed where susceptible Maine deer may contact and ingest them. Depending upon how the lure is handled, CWD contaminated deer lures could also be a source of exposure (and inadvertent ingestion) by people. In addition, researchers are demonstrating that once prions are in the environment they may contaminate the area by remaining in the soils for years to come.

At this time, we do not know whether any captive/farmed deer or elk used by the lure industry have ever contracted CWD. To date, deer lures are not being checked for the presence of CWD prions. Until more is known about whether commercial deer lures pose a realistic risk of spreading CWD, we recommend that hunters use caution in spreading urine-based lures in the environment and avoid placing the lures on their clothing or skin. Avoid placing deer lures on the ground or on vegetation where deer can reach them. Deer lures can be safely placed above deer height, allowing air circulation to disperse the scent. We would also strongly recommend using synthetic, non-urine based lures that have become available on the market until further research can show that deer urine does not pose a risk of containing infectious prions.

In 1997, the U.S. Food and Drug Administration (FDA) placed a total ban on the use of meat and bone meal from cattle, sheep, goats, as a component in commercial feeds for ruminants (including wild and domestic deer, and elk). Assuming all feed companies are complying with the FDA ban, commercial feeds commonly used to supplement the diets of captive/farmed or wild cervids would currently be free of CWD prions. However, we do not know whether commercial feeds formulated for non-ruminants (horse, swine, poultry, dog, and cat) contain meat and bone meal from CWD-infected deer or elk. When feeding wild deer or captive/farmed cervids, use only commercially available products formulated specifically for ruminants (deer, cattle, sheep, goats), or use whole grains (e.g. oats, corn) without supplements.



A more detailed report to the legislature regarding urine-based scents and deer feed can be found on our website here: http://www.maine.gov/ifw/hunting_trapping/hunting/MainesGamePlanForDeer.htm

What Can Deer, Moose, Elk, and Caribou Hunters Do to Avoid CWD Risks?

If you plan to hunt deer, moose, caribou, or elk in a state/province known or suspected to harbor CWD (see above for list of states and provinces), there are some commonsense precautions you should take to avoid handling, transporting, or consuming potentially CWD-infected specimens. The following precautions are adapted from the Wisconsin Department of Natural Resources:

General precautions:

- Do not eat the eyes, brain, spinal cord, spleen, tonsils, or lymph nodes of any deer.
- Do not eat any part of a deer that appeared sick.
- If your out-of-state deer is sampled for CWD testing, wait for the test results before eating the meat.

Field dressing and processing:

- Wear rubber or latex gloves while handling the carcass.
- Minimize contact with the brain, spinal cord, spleen, and lymph nodes (lumps of tissue next to organs or in fat and membranes) as you work.
- Do not cut through the spinal column except to remove the head. Use a knife or saw designated only for this purpose.
- Use a hunting knife, not knives used at the dinner table.
- Remove all internal organs for proper disposal by burial, or other means that prevents contact by live deer.
- Bone out the meat from the deer and remove all fat and connective tissue (the web-like membranes attached to the meat). This will also remove lymph nodes.
- Dispose of feet, hide, brain and spinal cord, bones, and head by burial, or other means that prevents contact by live deer.
- If processing deer from out-of-state CWD management or eradication zones, keep meat and trimmings from each deer separate.
- Clean knives and equipment of residue and disinfect in a 50/50 solution of household chlorine bleach and water for 1 hour.

Can I Bring Intact Deer, Moose, Caribou, or Elk Carcasses from Other States into Maine?

To prevent the introduction of CWD into Maine and pursuant to 12 MRSA Part 12, Chapter 903, Subchapter 2, §10103 sub-§2 and §10104 sub-§1, and in an attempt to eliminate or minimize the risk of introducing chronic wasting disease [CWD] into Maine, it is illegal for individuals to bring into Maine cervid carcasses or parts, except that the following carcass parts may be imported and possessed: boned-out meat, hardened antlers, skull caps that have been cleaned free of brain and other tissues, capes and hides with no skull attached, teeth, and finished taxidermy mounts.

Cervid carcasses or parts from the State of New Hampshire and the Provinces of New Brunswick, Labrador, Newfoundland and Quebec are exempt from this transportation restriction. The Commissioner may, pursuant to the statutory authority above, issue a permit to a person or institution for the purpose of importing other cervid carcass parts into Maine for possession in Maine. The Commissioner may set special conditions on the permit to mitigate potential disease-related impacts. This transportation restriction applies to both any cervid wild by nature and to any cervid killed in commercial hunting preserves that are taken in any state, province, or country outside of Maine.

Any person who imports into Maine any cervid carcass or parts described above, and is notified that the animal has tested positive for Chronic Wasting Disease, must report the test results to the Department within 72 hours of receiving the notification. In order to facilitate the proper disposal of any infected material, the Department may take into possession any imported carcass or carcass part of an animal, if the animal has tested positively for Chronic Wasting Disease.

Can I Get My Maine Deer, Caribou, Moose, or Elk Tested for CWD?

Although our system can accommodate enough samples (less than 1,000) from farm-raised and wild deer to scientifically monitor for CWD, we are not able to routinely test hunter-killed deer, moose, caribou or elk in Maine at this time.

What If I see a Deer or Moose Showing Signs of CWD in Maine?

If CWD were to emerge in Maine, early detection of diseased individuals provides the best means we have of controlling or eradicating the disease. Therefore, if you observe a deer or moose that clearly shows symptoms of CWD, do not kill or handle the animal. Report the sighting to an Inland Fisheries and Wildlife biologist or game warden. Report only deer or moose showing all or most of these CWD symptoms: extreme thinness, unaware or unafraid of people, shaking or unable to walk normally, drooling, can't raise the head, and ears drooping.

This work is supported by volunteer assistance, the federal Pittman-Robertson Funds program, and revenue from the sales of hunting licenses.

--Kyle Ravana

Moose

2012 Moose Harvest

Season Dates and Structure

Maine Moose hunters could hunt moose for 6 days by permit within the structure of a split season framework (September/October/November) during 2012. The September season ran from September 24th to September 29th, while the October season ran from the 8th through the 13th. For the 3rd year, a 3rd week of hunting was offered in the North Country (Wildlife Management Districts [WMDs] 1-8, and 11) from November 5th through November 10th. In 2011, WMDs 22 and 25 were added to the southern Maine moose hunt which includes WMDs 15, 16, 23 and 26. The southern Maine moose hunt runs concurrently with the November deer season from October 29th to November 24th and opened for Maine residents on October 27th.

Moose Permits and Applicants

The annual allocation of moose permits is a function of WMD-specific management goals. Moose management goals are categorized as either recreational, compromise, or road safety. Permit levels changed in 12 management districts between 2011 and 2012 providing an overall decrease of 137 permits. This included increased antlerless permits in WMDs 1, 3 and 4, as well as decreases in antlerless permits in WMDs 5-8 and 11. The number of moose permits allocated in 2012 was 3,725. Excess permits may be issued in a given year when permits are deferred one year due to permittee illness, armed service status, or similar situation.

During 2012, Antlerless-only Permits (AOPs) ranged from zero in 5 WMDs (districts 9, 14, 19, 27 and 28) to 300 in WMD 2. Among the 14 WMDs in which a cow harvest (and AOPs) was desired, the permit allocation totaled 1,460. The number of AOPs allocated in a given district is a reflection of a harvest level that will either grow, decline, or stabilize the district's population. Consequently, WMDs that can sustain only limited cow mortality are allocated relatively few antlerless permits. In contrast, WMDs that can support higher cow mortality, and still meet management objectives due to population size and structure, are allocated more permits. The southern Maine WMD moose hunt is a slight variation on this. Because of the low moose densities in southern Maine, only Any-moose Permits were allocated and the season was extended to the length of the November deer season to increase the chances of a hunter harvesting a moose. The November time frame was chosen to honor recommendations by landowners who wanted the southern Maine moose season to open concurrently with the November firearms season for deer.

Permits were allocated to qualified applicants in a random computerized lottery. Overall, 54,338 people applied for a moose permit during 2012. This included 39,681 residents and 14,657 non-residents. Out of those applicant pools, 8.5% of the residents and 2.5% of the non-residents were selected for permits.

Statewide Statistics for 2012

Overall, 2,937 moose were registered during 2012 (Table 10), which is a record harvest since the re-opening of the moose season in 1980. Since the re-institution of moose hunting in 1980, moose season timing (split seasons started in 2002) and areas open to hunting have changed several times.

Bull Harvest

The statewide harvest of antlered bulls during the Sept/Oct/Nov season (1,818) in 2012 marked a 14% increase from the previous year (1,593). Among the antlered bulls taken in 2012 (and aged by cementum annuli 1,579), 179 (11%) were 1½ years old (yearlings) sporting their first set of antlers, while 247 were 2½ years old, which made up 16% of the bull harvest. Mature bulls (4½ to 14½ years old) comprised 53% of bulls older than 2½ years.



On average, breeding bulls lose approximately 15% of their body mass during the rut. Because of this and the timing of the fall harvest, bull weights reflect a decrease in body mass from September to October. Average bull weights (yearling and older) in the 2012 harvest for September were 756 pounds versus 696 pounds (i.e., dressed weights) in the October harvest (an 8% decline). The heaviest bull weighed in at 1,103 pounds dressed (no digestive tract, heart, lungs, or liver) and was killed in WMD 1 during the September season (5.5 years old). The largest antler spread was 66 inches on this same bull sporting 26 legal points! Among antlered bulls examined in the harvest, 11% of the bulls sported cervicorn antlers (antlers without a defined palm) and 42% of these animals were yearlings; 13.5% were mature bulls (>4 years old) including the oldest at 9.5 years-old.

Antlerless Harvest

The statewide harvest of adult (yearling and older) cows during 2012 increased by 15% over the 2011 harvest (975 vs. 849, respectively); during 2011, antlerless-only permittees tagged 139 calves (86 males and 53 females). Overall 1,114 antlerless moose were registered by hunters during the 2012 season. This increase included the antlerless moose taken as part of the 135 Any-moose Permits issued within the southern zones. The antlerless moose harvest in the southern zones was comprised of 10 adult cows and 2 calves (2 males).

Table 10. Moose harvest by season, permit type (BOP: Bull-only; AOP: Antlerless-only; and, AMP: Any-moose) and success rate in 2012 statewide, Maine.

WMD	Season	Permit Type	Number of Permits	2012 Registrations		WMD	Season	Permit Type	Number of Permits	2012 Registrations	
				Kill	Success Rates					Kill	Success Rates
1	Sept.	BOP	90	90	100%	12	Oct.	BOP	35	27	77%
	Oct.	BOP	60	54	90%		Oct.	AOP	20	8	40%
	Oct.	AOP	50	47	94%	WMD Subtotals			55	35	64%
	Nov.	AOP	100	81	81%	13	Oct.	BOP	35	28	80%
WMD Subtotals			300	272	91%		Oct.	AOP	10	5	50%
2	Sept.	BOP	150	146	97%	WMD Subtotals			45	33	73%
	Oct.	BOP	150	138	92%	14	Oct.	BOP	35	28	80%
	Oct.	AOP	100	87	87%		WMD Subtotals			35	28
	Nov.	AOP	200	159	80%	15	Nov.	AMP-B		10	
WMD Subtotals			600	530	88%			AMP-C		4	
3	Sept.	BOP	100	97	97%	WMD Subtotals			25	14	56%
	Oct.	BOP	100	94	94%	16	Nov.	AMP-B		4	
	Oct.	AOP	150	122	81%			AMP-C		0	
	Nov.	AOP	150	124	83%	WMD Subtotals			20	4	20%
WMD Subtotals			500	437	87%	17	Oct.	BOP	20	6	30%
4	Sept.	BOP	200	184	92%		Oct.	AOP	10	2	20%
	Oct.	BOP	100	87	87%	WMD Subtotals			30	8	27%
	Oct.	AOP	100	86	86%	18	Oct.	BOP	50	20	40%
	Nov.	AOP	200	155	78%		Oct.	AOP	10	3	30%
WMD Subtotals			600	512	85%	WMD Subtotals			60	23	38%
5	Sept.	BOP	100	93	93%	19	Sept.	BOP	50	31	62%
	Oct.	BOP	25	25	100%		Oct.	BOP	25	14	56%
	Nov.	AOP	50	35	70%	WMD Subtotals			75	45	60%
	WMD Subtotals			175	153	87%	22	Nov.	AMP-B		1
6	Sept.	BOP	125	112	90%			AMP-C		1	
	Oct.	BOP	50	50	100%	WMD Subtotals			20	2	10%
	Oct.	AOP	50	37	74%	23	Nov.	AMP-B		1	
	Nov.	AOP	125	90	72%			AMP-C		5	
WMD Subtotals			350	289	83%	WMD Subtotals			45	6	13%
7	Oct.	BOP	125	91	73%	25	Nov.	AMP-B		5	
	Nov.	AOP	15	10	67%			AMP-C		3	
	WMD Subtotals			140	101	72%	WMD Subtotals			45	8
8	Oct.	BOP	235	190	81%	26	Nov.	AMP-B		2	
	Nov.	AOP	60	45	75%			AMP-C		1	
	WMD Subtotals			295	235	80%	WMD Subtotals			45	3
9	Oct.	BOP	50	45	90%	27	Oct.	BOP	20	7	35%
	WMD Subtotals			50	45		90%	WMD Subtotals			20
10	Oct.	BOP	60	50	83%	28	Oct.	BOP	25	14	56%
	Oct.	AOP	10	5	50%		WMD Subtotals			25	14
	WMD Subtotals			70	55	79%	OVERALL WMD TOTALS				
11	Sept.	BOP	25	23	92%				3,725	2,937	79%
	Oct.	BOP	25	25	100%						
	Oct.	AOP	25	11	44%						
	Nov.	AOP	25	18	72%						
WMD Subtotals			100	77	77%						

Moose Reproductive Data

Antlerless permits during the November season in WMDs 1-8 allowed us to collect reproductive data that are critical to assessing and monitoring population health and growth. In 2012, hunters removed and brought in 219 sets of moose ovaries for examination by biological staff. A cow's body weight and condition have a bearing on her potential to become pregnant, and on the number of offspring she will produce. Pregnancy rates of cow moose with age and weight data were normal at 80% overall. Typically, moose do not become pregnant until 2-years old. Of the cow moose examined this year, 30% of yearlings and 93% of the mature cows (2.5+ years) were pregnant.

Corpora lutea are identifiable structures within the ovaries that provide an indication of ovulation and potential pregnancy rates. Overall, there were 1.13 corpora lutea/cow older than 3.5 years. This may be an indication that moose in the

northern portion of the state are near ecological carrying capacity, since the amount of available forage (food) is what allows cows to attain the body weight necessary for reproductive success. We anticipate that additional sampling of female moose will provide a clearer picture of this relationship across northern Maine, as well as regionally.

Hunter Participation, Residency and Success Rate

In 2012, 3,362 residents and 363 non-residents won permits to hunt moose. A total of 348 non-residents were successful in their hunt providing a 96% success rate. Out-of-state hunters came from 36 states (as far away as Alaska) and 1 province (Quebec). The majority (14%) of out-of-state hunters came from Massachusetts. Resident success rates were 76% and, when combined with the outstanding success by out-of-staters, the total success rate was 79% statewide. Success rates over the last 9 years have been around 80%. Conditions for all three seasons were outstanding, with seasonably cool autumn temperatures, a marked change from the hot weather of 2011.

Changes for the 2013 Moose Season

In 2013, we will offer 4 separate moose hunting periods in Maine. The September season will run from September 23rd to September 28th in WMDs 1-6, 11 and 19; the October season will run from October 14th through the 19th and include WMDs 1-14, 17-19, 27, and 28. In WMDs 15, 16, 22, 23, 25 and 26, the season will coincide with November's deer season running from November 4th through November 30th. Opening day for Mainers will be on Saturday, November 2nd. Also for 2013, WMDs 1-5, 7, 8 and 19 will have an additional moose hunt in November from the 4th through the 9th. The month-long November hunt in southern Maine will again include WMDs 22 and 25, for a total of 130 permits allocated for any moose (bull, cow or calf). In total, Maine's moose hunt will offer 4,110 permits for 2013 -- the most ever allocated.

A New Era of Information on Moose in Maine

In the winter of 2010-11, IFW implemented a new aerial survey technique to estimate moose abundance in three northern WMDs. Over the next two winters, we completed surveys in an additional 6 northern WMDs, bringing the total area surveyed to 75% of the core moose range (essentially the commercial forestlands; WMDs 1-11 and 19). From these data, we were able to complete a reliable estimate of the statewide moose population. In conjunction with these surveys, we embarked on a second aerial survey technique to classify the composition of the moose population in terms of bull, cows, and calves across the core range. This past winter, we completed composition counts of 83% of our north-central units. These surveys provided IFW with the most complete picture of Maine's moose population to date (i.e., size and composition). With the reproductive data we collected on female moose (ovaries) and the information on bull and cow age structure obtained from moose teeth, we are developing a more complete picture of the status of our moose population. This information will in turn be used by biologists in recommending moose permit levels that ensure the public's management goals are being met.

The size of Maine's moose population is not static and will change annually in response to factors affecting the birth rates of calves (e.g., food availability) and the survival of adults and calves (e.g., hunter harvest rates and predation). Thus, Maine's moose population, which was at approximately 70,000 moose, is currently below that number, partially by design to bring a few northern districts into management objectives, but also due to slow population growth across the state and low to moderate calf survival. The Department is working on a proposal to monitor adult cow survival and potentially calf survival over the next few years to closely examine sources of mortality and quantify survival rates.

This work is supported by volunteer assistance, the federal Pittman-Robertson Funds program, revenue from sales of hunting licenses, and a grant from the Outdoor Heritage Fund.

--Lee Kantar

Black Bear

Maine's black bear, an iconic symbol of Maine's forests, is one of Maine's wildlife success stories. Once relegated to no more than a nuisance, the black bear has risen in stature to one of Maine's prized animals. Today, the expansive forest of northern, eastern, and western Maine supports one of the largest black bear populations in the United States (Figure 3).

Maine's bear population is valued not only by hunters, but others who enjoy watching wildlife and enjoy Maine's wildlife diversity. On the other hand, conflicts with people and bears do occur and, if bears become too abundant, that is not good for people or the bears. IFW strives to balance these needs and makes management decisions based upon science gathered from monitoring Maine's bear population, bear harvest, and conflicts. Maine's black bear population is closely monitored by Department biologists through one of the most extensive, longest running biological studies in the U.S that

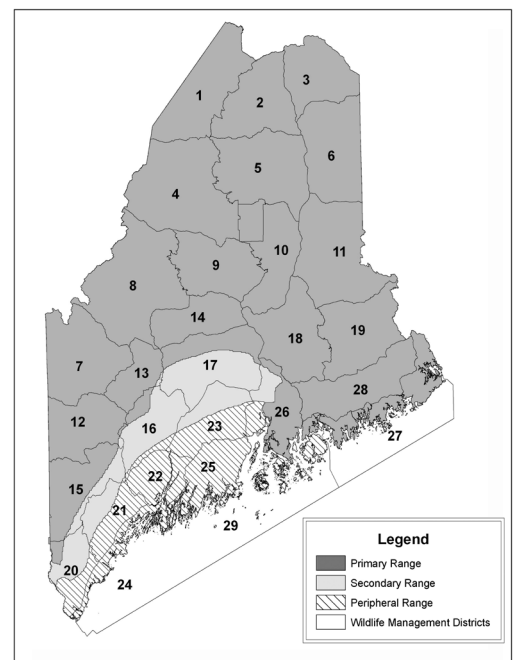

Figure 3. Maine Black Bear Range.

began in 1975, and continues today. Over the last 38 years, Department biologists have captured and tracked over 3,000 bears to determine the health and condition of Maine's bears and estimate how many cubs are born each year.

Since 2004, Maine's bear population has been increasing and is estimated at over 30,000 animals. Hunting is the Department's primary tool for managing this thriving bear population. To meet population objectives, a variety of traditional hunting methods are offered to hunters in Maine, including hounding, trapping, baiting, and still-hunting/stalking. Over 90% of the bear killed each year is by baiting, hounding, and trapping; still-hunting/stalking accounts for less than 10% of the harvest. However, even with ample opportunity, success rates remain in favor of the bear, where on average 26% of hunters using bait and hounds and 20% using traps actually harvest a black bear. Hunters that use still-hunting or stalking techniques to harvest black bears have the lowest success rates (<3%), due in a large part to Maine's dense forests.

Since 2005, the number of bears harvested each year has been below objectives leading to an increase in the bear population. Maine's bear population has grown from about 23,000 black bears in 2004 to over 30,000 black bears in 2010. Since bears are more common where human densities are lowest, the number of conflicts between humans and black bears in Maine is lower than other northeastern states and averages about 500 complaints each year. However, if Maine's bear population continues to grow, conflicts could rise as bears move into areas with higher human densities.

Maine's black bears are highly valued by outdoor enthusiasts and the general public. The Department of Inland Fisheries and Wildlife understands that a healthy, well managed bear population provides opportunities for everyone to enjoy. IFW biologists set management goals with public input through the Department's strategic planning process. Hunters in Maine are provided a variety of traditional hunting methods to meet these goals and ensure Maine's bear population continues to thrive without increasing conflicts in backyards and neighborhoods.

Living with Black Bears

The abundance of natural resources, including wildlife, is what makes life in Maine special and enjoyable. In fact, more than 90% of Maine is forested, which has allowed Maine's bear population to thrive. Despite a large population of bears, conflicts between people and bears are relatively few. However, if you live in a community that is experiencing problems with bears, this may not seem to be the case. Every spring, bears emerge from their winter dens and begin searching for food. Some bears encounter food odors that attract them to people's homes. Often, when berries begin to ripen in late summer, bears return to wooded areas to forage, which reduces conflicts with people. When natural foods are not abundant, bears are more likely to continue to search for food provided by people. The most common complaints we receive each spring involve bears feeding at bird feeders and on garbage. Although it may seem simple to move or destroy the offending bear, if you don't eliminate food odors, more bears will continue to visit your backyard.

All of us can take a few simple steps each spring to reduce undesirable encounters with black bears in our backyards:

- Bring your bird feeders in by April 1 and do not resume feeding birds until November.
- Store bird seed in a secure location and rake and remove waste seed from the ground.
- Keep your garbage secure in a building.
- Do not bring trash to the curb until the morning of pick-up.
- Keep dumpster lids closed and locked, and, if a dumpster is overflowing with garbage, call the disposal company and have the waste removed.
- Keep pet and livestock feed in a building or other secure enclosure.
- Clean or burn off outdoor grills to reduce food odors; if possible, store the grill in a building when not in use.
- Use electric fencing around bee hives and avoid setting hives close to forested edges.
- When possible, keep livestock and poultry indoors at night.

Remember, if your neighbors are not taking these steps as well, bears may continue to frequent the area.

Many people expect the Department to move bears that are frequenting backyards, communities, agriculture crops, and livestock because trapping and moving bears provides a quick fix to a problem and is perceived as a humane response. However, trapping and moving a bear is not always appropriate or effective. Bears that are trapped and transferred to a new area do not stay where they are released. Often these bears return to the area or create problems in other areas. Relocated bears are at greater risk of mortality as they encounter more roads, other bears, and people. However, it may be appropriate to move a bear in some situations to provide a temporary solution. But after the bear is moved, attractants must be removed or secured to prevent future problems. To avoid enticing bears to your backyard or field, the best solution is to remove/secure common bear attractants every spring before you experience problems. To learn more about what you can do to minimize conflicts with bears visit http://www.maine.gov/ifw/wildlife/human/lww_information/bears.html.

The 2012 Black Bear Hunting and Trapping Season

The Department's management of Maine's black bears includes regulating the harvest by setting the season length, bag limit, and legal methods of hunting. We require that hunters report their harvest so we can monitor harvest levels.

The Department can make adjustments to these regulations as needed to meet Maine's bear harvest objectives.

Currently, hunters are allowed to harvest bears during the fall using a variety of methods. The general hunting season for black bears opens the last Monday in August and closes the last Saturday in November. Hunters are allowed to hunt bears near natural food sources or by still-hunting throughout this 3-month period. Hunting bears over bait is permitted for the first 4 weeks and with the use of hounds for a 6-week period that overlaps the last 2 weeks of the bait season.

Trappers can harvest a bear in September or October. Trappers must use a cable foot snare or cage style trap and, since 2008, are required to purchase a separate permit to trap a bear. Trapping continues to be on the rise, with the number of trappers purchasing a permit to trap bears reaching a new high in 2012; 459 residents and 49 non-residents bought trapping permits and harvested 53 and 18 bears, respectively. A new law that took effect in late September of 2011 allows two bears to be harvested if one is taken by trapping. Fourteen bears were trapped in 2012 by hunters who harvested another bear by other methods.

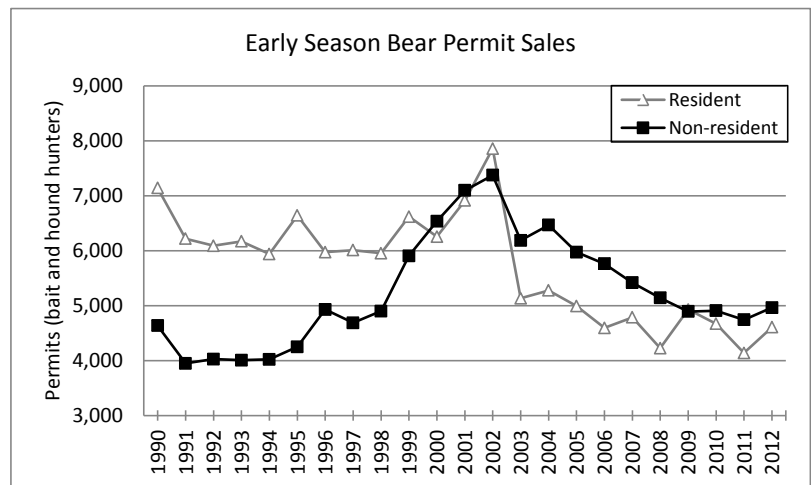

Most bears in Maine are harvested by hunting over bait. In 2012, 81% were taken over bait, 11% with hounds, 2% by deer hunters, 3% by still-hunting or stalking prior to deer season, and 2% in traps. Few bears were harvested in central and coastal Maine (i.e., Knox, Lincoln, Waldo, Androscoggin, Cumberland, Sagadahoc, Kennebec, and York counties) where bear populations are low and hunting opportunity is limited.

The 2012 harvest of 3,207 bears is the second highest bear harvest since 2005, following a record low harvest in 2011. Many factors influence the harvest of black bears in Maine with the abundance of natural foods during the baiting season being first and foremost. The weather during the 4 week season, especially during the first 2 weeks, also impacts the final tally. Less abundant natural foods in the late summer and early fall increase bait interest and bear activity. As a result, 2012 was a good year for hunting bears over bait. Hunters and guides reported more bears visiting bait sites than in 2011, when natural foods were abundant. Because the bait harvest comprises the greatest portion of the overall harvest, it has the greatest effect on the final harvest figures. Last year's low number of early-season bear hunters (prior to deer season) appears to be an anomaly with permit sales in 2012 returning to previous levels. Although non-resident permit holders account for

Table 11. Number of bears harvested in Maine in 2012 by Wildlife Management District (WMD).

WMD	Method of Take					Total Harvest	Assisted by Guide	Resident	Non-resident
	Hunting with Bait	Hunting with Dogs	While Deer Hunting	Trapping	Unknown				
1	145	6	0	0	5	156	149	11	145
2	105	18	0	3	6	132	116	20	112
3	153	5	1	3	6	168	119	58	110
4	209	3	3	0	8	223	174	52	171
5	162	22	1	1	1	187	159	28	159
6	188	10	0	3	10	211	145	67	144
7	120	15	1	7	2	145	90	54	91
8	187	38	2	12	3	242	151	108	134
9	92	2	0	0	3	97	48	42	55
10	133	13	1	2	1	150	105	46	104
11	249	29	1	5	4	288	199	71	217
12	121	42	0	6	1	170	72	107	63
13	32	13	4	2	0	51	26	26	25
14	55	16	1	2	0	74	56	26	48
15	38	23	16	2	6	85	10	68	17
16	2	0	3	1	1	7	0	7	0
17	33	7	7	0	3	50	14	36	14
18	168	18	3	2	13	204	114	100	104
19	118	41	1	2	4	166	132	27	139
20	2	1	6	1	3	13	0	13	0
21	1	0	0	0	0	1	0	1	0
22	0	0	0	0	1	1	0	1	0
23	4	0	1	1	0	6	0	6	0
24	0	0	0	0	1	1	0	1	0
25	0	0	1	0	0	1	0	1	0
26	58	1	3	3	6	71	13	58	13
27	67	2	1	6	2	78	24	53	25
28	171	43	3	2	10	229	147	98	131
29	26	3	1	0	1	31	15	21	10
Totals	2,613	368	60	66	100	3,207	1,026	1,186	2,021

just over half of Maine's bear hunters, they continue to harvest close to 2/3 of the bears taken. While most non-resident hunters hire a guide, fewer resident bear hunters hire guides, which may account for the higher success rate of non-resident hunters (in 2012 resident success rate = 22% and non-resident success rate = 39% during the early season). In 2012, non-resident hunters harvested the majority of bears during the bait (65%) and hound seasons (69%). Hunting over bait is also the most popular method for resident bear hunters and accounted for 77% of the bears harvested by Maine residents. Although few bears are taken during the firearms season for deer or in traps, Maine residents harvested the majority of bears taken by these methods (85% and 80%, respectively in 2012; Table 11).

Non-resident hunters became more interested in hunting black bears in Maine following the closure of the spring bear hunt in Ontario in 1999. Their interest remained high until 2003, when a rise in permit fees lowered participation by both non-resident and resident hunters (resident price increased from \$5.00 to \$25.00 and non-residents from \$15.00 to \$65.00). After this sharp decline in bear hunters in 2003, and a slight bump in bear hunting participation during the bear hunting referendum year (2004), bear hunter numbers have declined steadily. This downward trend in participation rates is especially significant for non-resident hunters. The downturn in the U.S. economy has likely contributed to recent lower bear hunter participation, especially among non-residents. Since non-resident hunters enjoy a higher success rate than residents, loss of these hunters has a greater effect on the final harvest, and bear population, than a similar loss of resident hunters. If hunter participation does not increase, we may need to increase hunting opportunities to meet bear management goals.

Starting in 2008, trappers and non-resident deer hunters are required to purchase a bear permit to harvest a bear by trap or during deer season. Funds from these permit sales are dedicated to bear research and management. Currently, we are using these funds to age teeth from harvested black bears, which will allow us to monitor the age structure of Maine's bear population and trends in bear numbers. In 2012, 702 non-resident bear permits for deer season and 508 trapping permits were sold.

This work is supported by volunteer assistance, the federal Pittman-Robertson Funds program, and revenue from the sales of hunting and trapping licenses.

--Randy Cross and Jennifer Vashon

Canada Lynx

The lynx is a medium-sized cat and can be distinguished from a bobcat by its completely black-tipped tail, longer ear tufts, and larger paws. Lynx populations are influenced by the numbers and distribution of snowshoe hare -- their primary prey. Maine is at the southern extent of the lynx range where forests transition from spruce-fir to hardwood and where winter snow depths lessen. When compared to historic records, snow track surveys initiated in 2003 indicate that lynx distribution has not changed substantially over the last 100 years. Lynx remain common north of Moosehead Lake and west of Route 11. In recent years, lynx have become more common in eastern Maine. Canada lynx are federally-listed as a threatened species, and Maine is home to the largest breeding population of Canada lynx in the eastern United States.

A History of Lynx in Maine

Historically, it appears that lynx have persisted in low numbers with brief periods of abundance. Lynx numbers are tied to the abundance of snowshoe hare, which are most numerous in young stands of spruce and fir forests or in older spruce and fir forests with a dense understory of young trees. Lynx were relatively common in the mid-1800s following a major spruce budworm outbreak and subsequent harvest of spruce and fir that created ideal habitat for their prey. As the forest matured, lynx became less common. By the late 1970s, the amount of mature spruce and fir forest reached record high levels, which helped trigger another major budworm outbreak. The extensive clearcutting that followed created record levels of lynx habitat by the late 1990s and remains today. As a result, Maine's lynx population is likely at a historic high, conservatively estimated at between 750 and 1,000 adult lynx in the core range in 2006. Sightings of lynx in recent years, suggest that lynx numbers are likely continuing to increase, with lynx remaining in the core range and beginning to occupy more southern areas (Figure 4).

State and Federal Protection

In 1967, a statewide bounty on all wildcats, including lynx, was repealed and hunting and trapping seasons for lynx were closed. Thirty years later, IFW designated lynx as a species of special concern in Maine. The special concern

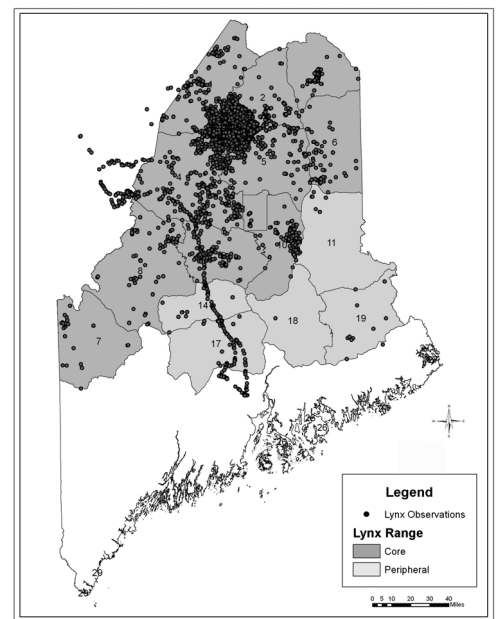

Figure 4. Lynx observations and geographic range in Maine.

designation is given to species when there is some management concern and more information is needed to determine whether additional protection is warranted. In 2000, the U.S. Fish and Wildlife Service (USFWS) listed lynx as a threatened species in 14 states, including Maine. Information gathered from snowtrack surveys and telemetry studies in northern Maine after lynx were federally-listed indicate that lynx do not meet the state's threatened or endangered listing requirements. Although the USFWS has drafted a recovery outline for lynx that serves as an interim guide for recovery, a species status and need for continued protection under the U.S. Endangered Species Act cannot be evaluated without a recovery plan.

As a federally-listed species, lynx are protected from intentional and accidental take that may or may not result in the direct death of a lynx. The Department and the USFWS have been working on methods to minimize potential incidental trapping of lynx in Maine. This year, the Department submitted a revised incidental take plan that would allow a low level of incidental take of lynx by fur trappers. This plan provides measures to minimize the accidental catch of lynx in traps. The USFWS is currently reviewing this plan. Since altering upland trapping regulations in 2008, specifically to protect lynx, no lynx have been killed in traps legally set in Maine. Each year, a few lynx are captured in foothold traps and IFW biologists examine as many of these animals as possible prior to release. Most lynx caught have no or minor injuries and are released at the trap site.

From Research to Management

Biologists at IFW have been in the process of building a lynx management system that involves collecting field data, analyzing what it means, getting input from the public on management goals, and developing a monitoring plan. The process started in the winter of 1999 with the first radiotelemetry study on Canada lynx in Maine. In 2011, Department biologists shifted their focus from acquiring field data, to applying information from this long-term study, to management and conservation strategies for lynx in northern Maine. In 2012, we prepared an assessment of lynx habitat and population levels in Maine to guide future management decisions. This document is available on the Department's website and describes what is known about Canada lynx in the northeastern U.S.

The Lynx Assessment relied heavily on our 12-year study of lynx in northern Maine. From 1999-2011, Department wildlife biologists captured and radiocollared 85 lynx and documented the production of 42 litters of kittens on a study area in northern Maine. By studying lynx for 12 years, we were able to determine what habitats lynx prefer, how much area a lynx uses, and the quality of these areas based on the ability of lynx to survive and reproduce. Data from this study have shown that lynx and snowshoe hares thrive in the regenerating thickets of spruce and fir following logging, and lynx can exist at high densities in northern Maine when this ideal habitat is common. The reproduction and survival data demonstrated that the studied population of lynx in northern Maine was producing an excess number of animals, allowing lynx numbers to increase and colonize new areas.

To learn more about lynx in Maine, visit: http://www.maine.gov/ifw/wildlife/management/lynx_theMaineStory.htm.

This work is supported by the federal State Wildlife Grants and Pittman-Robertson Funds programs, and state revenues from the Loon Conservation license plate, Chickadee Check-off, and sales of hunting and trapping licenses.

--Jennifer Vashon

Furbearers and Small Game Mammals

Furbearers include all mammals harvested primarily for their pelts. In Maine, these include coyote, red and grey fox, bobcat, fisher, marten, raccoon, skunk, short- and long-tailed weasels, mink, otter, beaver, muskrat, and opossum. The pelts of all furbearers, except weasel, raccoon, muskrat, skunk, and opossum are tagged for tracking the furbearer harvest. Pelt tagging is one of the primary population indices used in our furbearer management systems. Furbearers are primarily trapped but some species (i.e., fox, coyote, bobcat, raccoon, and skunk) are also hunted. Small game that can be hunted includes snowshoe hare, gray squirrel, woodchuck, porcupine, and red squirrel.

Overview of Trapping Season

Fur prices were higher for many species than they have been in recent years. The North American Fur Auction reported that last year's fur sales were the best since 1987. Fisher pelts were sold for \$150, marten for over \$100, and grey fox for \$50. Trappers that pursued marten were more successful than they have been in the past several years. The high marten harvest indicates that the marten population was abundant last fall, likely due to the abundant food resources and mild winter the previous year. Grey foxes continue to increase their numbers and range in Maine. Their increased distribution and high pelt prices contributed to the largest grey fox harvest on record in Maine. Most of the furbearers harvested in Maine were within the previous five-year averages or just slightly below (Table 12).

New Marten Research

Currently, IFW monitors Maine's marten population by analyzing fur harvest records and trapper success rates. However, a number of factors may influence success and harvest rates, and thereby mask true trends in Maine's marten population. Changes in food abundance, for example, may affect the vulnerability of marten to baited traps and, consequently, lead

to dramatic changes in harvest and success rates. These changes in harvest and success rates do not reflect changes in the number of marten in the population, but simply their vulnerability to trapping. Similarly, an increase in fur prices may motivate trappers to

Table 12. Harvest of furbearing animals in Maine. Harvest records are from pelt-tagging records collected from the 2005-2006 to 2012-2013 trapping seasons. Pelt-tagging records may under-represent the harvest of coyote and beaver. Harvest figures followed by an h superscript were significantly higher than the average harvest the previous 5 years for that species. Harvest figures followed by an L superscript were significantly lower than the mean harvest for that species the previous 5 years.

Species	12-13	11-12	10-11	09-10	08-09	07-08	06-07	05-06
Beaver	9,063	15,769	6,976	10,765	9,119	6,357	12,635	11,094
Bobcat	205 ^L	239	305	281	407	410	344	344
Coyote	1,670 ^L	2,037	1,623	1,743	1,901	1,819	1,521	2,077
Fisher	1,242	925	1,207	1,078	1,456	993	1,968	1,810
Red fox	991	989	922	932	893	1,030	1,245	1,067
Grey fox	426 ^h	308	332	250	163	161	107	67
Marten	3,805 ^h	1,317	3,559	2,613	2,291	2,401	2,350	3,873
Mink	2,184	2,339	1,926	1,465	1,297	1,888	2,280	1,108
Otter	646	1,234	754	696	528	493	968	1,041

put out more traps and result in more marten being caught per trapper (i.e., trapping success rate) and higher harvest rates. IFW is interested in developing methods to monitor the marten population that more accurately reflect the true population dynamics of Maine's marten population. Improving our accuracy in monitoring marten populations is warranted considering the dependence of marten on conifer forests, the dramatic changes in forestry practices that have occurred over the last 20 years, and predictions from climate change modeling that foretell of significant changes to Maine's northern forests.

Starting in September 2013, IFW will collaborate with the Cooperative Fish and Wildlife Research Unit at the University of Maine on marten research to improve marten and other furbearer monitoring. The objectives of this research include (1) determining the relationship between true changes in the marten population and various methods of monitoring furbearer populations, (2) determining which monitoring indices are the most sensitive in detecting trends, and (3) determining which methods are the most cost-effective for monitoring population trends. This study will be conducted by a doctoral student and is expected to take up to 5 years to complete. The results of this project will be incorporated into a marten monitoring protocol that, when implemented, will be used to better inform management decisions for this important furbearer species in Maine.

The Otter Predicament

Otters are enjoyable to watch and are one of Maine's most valuable fur species. IFW balances the desires of people interested in seeing otter in the wild and trapping of otters through a closely regulated trapping program. With adequate regulations, and with the cooperation of trappers, IFW is maintaining Maine's otter population for future generations of Mainers to enjoy.

Otters share Maine's vast forested wetlands with beaver. Beaver are considered a keystone species which, in essence, means that beavers, and the wetlands they create, support many species of fish and wildlife, including otter. Beaver, however, have another side to their story. Beaver, by virtue of their dam building activity, cause flooding that can be detrimental to the roads and forests of large landowners. Beaver are also one of the most trapped furbearers in Maine. Over the years, Maine's beaver trapping season has been extended several times to allow trappers to catch beaver in late winter and early spring. These season extensions assisted landowners in helping reduce the damage to roads and property and gave trappers more opportunities to trap an abundant resource. One drawback to long beaver seasons is that otter are incidentally caught in beaver traps outside of the regular otter trapping season. In recent years, nearly 30% of the otter that are trapped each year have been trapped past the closure of the regular otter trapping season.

IFW biologists and trappers in the Maine Trapper's Association have been trying to address the problem of incidental otter catch outside of the otter season. In particular, IFW and trappers have been working to develop regulations that allow trappers to continue to catch beaver in the spring, but reduce the incidental catch of otter.

One alternative being considered is changing the configuration of the trigger on killer-type traps (Figure 5). Over 15 years ago, the New York Department of Conservation tested #330 killer-type traps (a trap

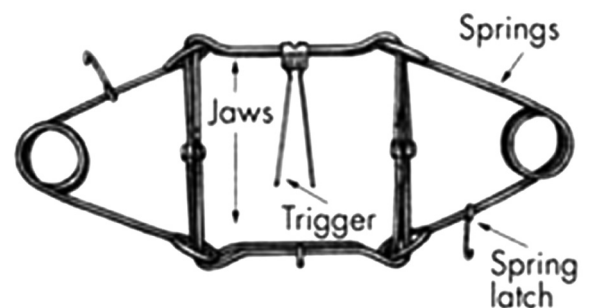

Figure 5. Diagram of a Standard Killer-type Trap and Its Various Parts (AFWA 2006).

with a 10 in. x 10 in. jaw spread commonly used to catch beaver under water) to determine whether moving the triggers from the middle of the trap to the side of the trap would reduce the number of otters caught and still allow the trap to efficiently catch beaver. They determined that if an otter swam through a trap with the trigger mounted in the middle of the trap (top or bottom mount), 60% to 90% of otter swimming through a trap would be caught. However, if the trigger was moved to one side of the trap, only 15% of the otter would be caught. Traps with the triggers moved to one side still caught 90% to 100% of the adult beaver swimming through them and 60% to 90% of the sub-adult beaver. In the field, traps with triggers placed to the side caught just as many beaver as traps with the standard configuration.

Other alternative regulations IFW and trappers considered for reducing the incidental catch of otter included positioning the trap so that the opening of the underwater trap is parallel to the stream bank. Setting the trap this way would allow trappers to catch beaver as they tried to enter a den made in the bank of the stream, but would avoid otter swimming through the channel of the stream. IFW has also proposed limiting the number of incidentally caught otter a trapper could keep after the otter season closes. IFW continues to work with the trappers to identify options that protect the resource and do not unnecessarily penalize spring beaver trappers. Both trappers and biologists recognize the need to establish regulations that insure otters are not overharvested.

This work is supported by volunteer assistance, the federal Pittman-Robertson Funds program, revenue from the sales of hunting and trapping licenses, and funds from the Loon Conservation Plate.

--Wally Jakubas and John DePue

Bats and White-nose Syndrome

White-nose syndrome (WNS) is a disease that affects winter hibernating bats and is associated with a newly discovered fungus, *Geomyces destructans*. The disease was named white-nose syndrome because infected bats have a white fungus on their muzzles. The fungus infects hairless portions of their body, such as their nose and wings, and can affect their behavior and metabolism. WNS causes hibernating bats to awaken more often during hibernation and prematurely use up fat reserves needed to survive the winter. The U.S. Fish and Wildlife Service (USFWS) estimated that WNS has already killed more than 5 million bats. WNS was first documented in New York in 2006 and has since spread throughout much of the eastern half of North America (24 states and 5 Canadian Provinces), including Maine.

To date, there have been no known illnesses to humans attributed to WNS. Scientists are still learning about WNS, but the fungus lives in cold damp environments and we know of no risk to humans from contact with infected bats.

In March 2013, IFW biologists conducted bat surveys at hibernacula in Maine. Unfortunately, the sites that were initially infected in 2011 have had dramatic declines of hibernating bats, up to 100% from pre-WNS surveys. Additionally, the one remaining uninfected site in Maine showed signs of WNS on the bats in 2013. For the third year, MDIFW, with partners from federal agencies, NGOs, and volunteers, has conducted surveys to determine bat population trends in Maine. Bat population data were collected by conducting acoustic surveys that record the call sequences of bats and maternity emergence counts.

In 2013, MDIFW obtained funding from the USFWS to develop and produce outreach and educational materials about bats, the importance of bats to Maine, and the perils that bat populations face. Please contact your local IFW office if you are interested in any bat informational materials.

This work is supported by volunteer assistance, the federal State Wildlife Grants program, and state revenues from the Loon Conservation Plate, Chickadee Check-off, and Outdoor Heritage Fund awards.

--John DePue

New England Cottontail

About the Rabbit

The New England cottontail (NEC; *Sylvilagus transitionalis*), or cooney, was listed as state endangered species in Maine in 2007 and is Maine's only endangered terrestrial mammal. Formerly, NEC ranged from Belfast to Kittery. As of the winter of 2012-2013, we know of no rabbits north of Portland. In 2010, Maine's NEC population was estimated to be less than 200 rabbits. The number of NEC in Maine was determined by conducting intensive winter searches for fecal pellets throughout southern Maine for several years. The DNA in these pellets was analyzed to determine whether the pellet was deposited by a snowshoe hare (*Lepus americanus*) or NEC and to distinguish individual rabbits. The U.S. Fish and Wildlife Service (USFWS) considers the species to be warranted but precluded from listing under the federal Endangered Species Act. Although NEC are currently considered warranted but precluded for federal listing, the USFWS must make a final determination on their federal listing status by 2015, as the result of a court settlement (2011 Multi-District Litigate Agreement) that directed the USFWS to greatly speed up their listing process.

The region-wide decline of the NEC population has been attributed to habitat loss, in particular, the loss of old field and shrubby habitat. Outside of Maine, NEC must compete with the non-native eastern cottontail rabbit (*Sylvilagus floridanus*) for limited habitat. Unfortunately, the eastern cottontail uses a wider diversity of habitat and is better at avoiding

predators than the NEC. Most people have a hard time believing that an animal that “breeds like a rabbit” could become endangered. The fact that a species, with a high reproductive rate like the NEC’s, is endangered (state listed in Maine and New Hampshire) begs the question -- if New England’s only native cottontail is endangered, what does it say about the status of other wildlife that live in brushy/early successional habitats or the health of the ecosystem in which they live?

Today, NEC occupy less than 20% of their former range. In Maine, they exist in three known populations: 1) Cape Elizabeth/Scarborough, 2) Wells, and 3) Kittery/York/Elliot. These populations are not only separated by distance but also by a landscape fragmented with roads and unsuitable habitat. Landscape fragmentation and the physical distance between NEC populations prevent NEC from moving between populations. Consequently, Maine’s NEC populations are losing their genetic diversity and have a high risk of becoming extirpated (locally extinct), unless management actions are taken.

Management Strategies

While IFW oversees NEC recovery efforts in Maine, much of the recovery work on NEC is accomplished by governmental and non-governmental partners working with IFW through Maine’s NEC Working Group. In particular, the National Fish and Wildlife Foundation (NFWF), through its Keystone Initiative Program, provides essential support for NEC conservation. As a result of programs like the Keystone Initiative, over 700 acres of habitat have been brought under management for NEC in Maine. This last year, over 100 acres of habitat on private and public land were actively managed (e.g., timber harvesting, mowing, brush-hogging) for NEC. Although this is an excellent start, IFW and its partners have set a goal of creating over 5,140 acres of NEC habitat by 2030. Regional biologist Cory Sterns, or Kelly Boland, Maine’s NEC Restoration Coordinator, can help landowners interested in managing their land for NEC. Programs like the Landowner Technical Assistance Program (Natural Resources Conservation Service [NRCS]), and the Partners Program (USFWS) have been established to assist landowners interested in managing their lands for wildlife; including NEC. Incentives are available for qualifying landowners for managing NEC under federal Farm Bill programs like the Wildlife Habitat Incentives Program (WHIP). These programs provide a win-win situation for landowners and wildlife.

Within greater New England, Maine is a member of the Regional New England Cottontail Initiative, which is made up of representatives from state wildlife agencies: CT, MA, ME, NH, NY, and RI; federal agencies: NRCS and USFWS; and a non-profit organization: Wildlife Management Institute. Late in 2012, Maine, along with the other members of the Initiative, formally adopted the Regional Conservation Strategy for NEC. The Strategy gives a “soup to nuts” description of administrative tasks, habitat management actions, population monitoring, research, and the public outreach needed to achieve regional and state objectives. For the region, the Strategy (<http://newenglandcottontail.org/>) calls for the creation of an additional 51,665 acres of NEC habitat on federal and state lands by 2030. This amount of additional habitat should support a NEC population of 28,000 rabbits. Each state identified focal areas in which to concentrate their restoration efforts. Maine has 6 focal areas for management that run from Scarborough to Kittery. Our objective is to create habitat around existing NEC populations and allow the NEC to expand throughout their former range. A key to the expansion will be the utility corridors that run north and south through this region. We are working with companies, like Central Maine Power, to improve the brushy habitat under their power lines. We hope that NEC will use utility corridors as travel corridors to repopulate areas when habitat becomes suitable. By 2030, our goal is to have at least 2,500 rabbits in Maine.

Part of the Regional Initiative’s population management plan includes a captive breeding program at the Roger Williams Park Zoo in Rhode Island. Currently, the zoo has 17 adult female and 10 adult male NEC for captive breeding. This includes 2 males and 2 females from Maine, which were brought to the facility in 2013. Rabbits are housed and bred in an enclosed facility and given excellent veterinary care. After newborn rabbits are weaned, they are transferred to pens where they become accustomed to living in an outdoor environment. After this acclimation period, they are ready for release. One of the first releases was to Patience Island, off of the Rhode Island coast. After one year, 9 of 15 rabbits have survived on the island. If a breeding colony of rabbits can be established on this Island, the rabbits will be removed and released on the mainland. For an alternative method, New Hampshire has constructed a holding pen on the mainland and hopes to be able to release rabbits soon. New England cottontails in Maine and New Hampshire have similar genetic profiles. Therefore, there is a good chance that Maine rabbits bred in captivity could one day be released in New Hampshire to help New Hampshire’s NEC population recover. The captive breeding program is still considered experimental. A major question that needs to be answered before IFW translocates captive-bred rabbits into Maine is -- how well will captive-bred rabbits survive and breed on the mainland?

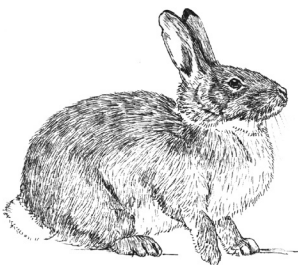

This work is supported by volunteer assistance, the federal State Wildlife Grants program and Pittman-Robertson Funds program, state revenues from the Outdoor Heritage Fund, Loon Conservation Plate, Chickadee Check-off, the sales of hunting and trapping licenses, and other support from the NFWF, the Wildlife Management Institute, USFWS Partners Program, Rachel Carson National Wildlife Refuge, NRCS, Wells National Estuarine Reserve, Kennebunkport Conservation Trust, and many other private and public landowners and organizations.

--Wally Jakubas

REPTILE, AMPHIBIAN, AND INVERTEBRATE GROUP

Maine is home to 18 species of frogs and salamanders (amphibians), 16 species of turtles and snakes (reptiles), and over 16,000 species of terrestrial and freshwater invertebrates, from beetles and butterflies to mayflies and mussels, to name just a few. Coordinating research and conservation priorities for such a diverse suite of organisms is challenging! One of the Group's highest priorities is to address the recovery needs of the large number of reptiles and invertebrates currently on the state's list of Endangered and Threatened species (21 of 46 species). Some rare invertebrates, such as the Katahdin Arctic Butterfly and Roaring Brook Mayfly, are state or regional endemics – found nowhere else in the world but in Maine or a small area of the Northeast. The Reptile, Amphibian, and Invertebrate (RAI) Group works to ensure that these, and other less familiar but ecologically important, species remain a part of Maine's rich natural heritage.

Directed by a legislative resolve, a public poll in December 2009 confirmed that a majority of Maine citizens believe the Department is funded largely from State general revenues. This is not the case. In fact, almost no Department revenue is provided by State general funds. The Reptile, Amphibian, and Invertebrate Group is one of the Department's few units devoted entirely to nongame and wildlife diversity services and is wholly dependent on nontraditional sources of revenue; mainly the Loon Conservation License Plate and Chickadee Check-off. Unfortunately, both of these funding sources have been in decline, and a more dependable revenue stream is critical if the Department is to meet its legislative mandate "to conserve, by according such protection as is necessary..., all species of fish or wildlife found in the State, as well as the ecosystems upon which they depend".

Phillip deMaynadier, Ph.D., Wildlife Biologist and Group Leader – Phillip supervises Group activities and serves as the Department's lead biologist on issues related to amphibians, vernal pools, butterflies, damselflies, and dragonflies. He also represents the Department on several state and regional nongame working groups.

Beth Swartz, Wildlife Biologist – Beth serves as the Department's lead biologist on aquatic invertebrate issues, with recent efforts devoted to conservation of Clayton's Copper butterfly, freshwater mussels, and rare mayflies. Beth also helps coordinate the Department's vernal pool data review responsibilities.

Derek Yorks, Wildlife Biologist – Derek serves as the Department's lead biologist on reptile issues, where he coordinates research and conservation efforts on several rare turtle and snake species. Derek is currently focused on a multi-state survey and monitoring effort to assess the distribution and status of Blanding's Turtles in the Northeast.

Seasonal Staff/Cooperators – The RAI Group could not have worked with such a diverse suite of taxa without benefit from the expert services provided by the following professionals in 2012-2013: Paul M. Brunelle, Dr. Ron Butler, Dan Hansche, Ken Hotopp, Dr. Cynthia Loftin, Dr. Marilyn Mayer, Jonathan Mays, Dr. Allison Moody, Ethan Nedeau, Trevor Persons, Bronco Quick, Jen Raber, Justin Schweitzer, Marcia Siebenmann, Mark Ward, Dr. Reggie Webster, and Dr. Herb Wilson.

REPTILE, AMPHIBIAN, AND INVERTEBRATE CONSERVATION AND MANAGEMENT

Amphibians and Reptiles

Partners in Amphibian and Reptile Conservation (PARC)

MDIFW continues to cooperate with an initiative entitled Partners in Amphibian and Reptile Conservation (PARC). Modeled partly after the successful Partners in Flight (PIF) bird conservation program, PARC's mission is to forge partnerships among diverse public and private organizations in an effort to stem recent declines of amphibian and reptile (herpetofauna) populations worldwide. MDIFW regularly participates in northeastern chapter PARC meetings including the most recent 2013 annual meeting in Branchville, New Jersey.

To date, PARC-Northeast has made progress on a) drafting model state herpetofauna regulations, b) compiling a list of regional species of conservation concern, c) publishing management recommendations for important habitats, and d) designing guidelines for identifying high value areas entitled Priority Amphibian and Reptile Conservation Areas (PARCAs).

Recognizing that habitat loss and fragmentation is the greatest threat to reptiles and amphibians worldwide, the PARCA project is an initiative to develop a network of focus areas in the U.S., designed specifically for the unique conservation needs of reptiles and amphibians. Areas are nominated using scientific criteria and expert review, drawing on the

concepts of species rarity, richness, regional responsibility, and landscape integrity. PARCAs are a nonregulatory designation, whose purpose is to raise public awareness and spark voluntary habitat protection by landowners and conservation partners. PARCAs are not designed to compete with existing landscape biodiversity initiatives, but to complement them – providing an additional spatially explicit layer for conservation consideration. With significant support from the U.S. Fish and Wildlife Service, MDIFW is working closely with researchers at the University of Maine (Cyndy Loftin and Allison Moody) and Clemson University (Kyle Barrett and Bill Sutton) to develop a science-based framework for identifying PARCAs throughout the Northeast.

For more information on this or other national PARC conservation efforts, or to join the northeastern chapter, visit the PARC website at www.parcplace.org.

This work is supported by the USFWS Landscape Conservation Cooperative program, the federal State Wildlife Grants program, and state revenues from the Loon Conservation Plate and Chickadee Check-off funds.

--Phillip deMaynadier and Derek Yorks

Maine Amphibian and Reptile Atlas Project (MARAP)

From 1986–1990, MDIFW, in cooperation with Maine Audubon and the University of Maine, conducted the Maine Amphibian and Reptile Atlas Project (MARAP). During a four-year period, over 250 volunteers from around the state contributed approximately 1,200 records of observations of amphibians and reptiles. This initiative culminated in the 1992 publication of the book *The Amphibians and Reptiles of Maine*. The first edition sold out within two years of publication.

By 1998, considerable new data had been compiled, and there was increasing demand for updated information on the state's amphibians and reptiles. Editors Malcolm Hunter, Jr., Aram Calhoun, and Mark McCollough revised a second edition, incorporating information from 1,300 new records into updated range maps and species narratives, and added color photographs and a CD of the calls of the frogs and toads of Maine. Copies of the updated 1999 edition of *Maine Amphibians and Reptiles* can be ordered for \$19.95 from MDIFW's Information Center (207-287-8000) or from the online store found on the Department's website: <http://www.maine.gov/ifw>.

MDIFW continues this atlas work and maintains a comprehensive database on the distribution of Maine's 34 amphibian and reptile species. Though most of this work is opportunistic, as of Summer 2013, over 9,200 entries from more than 760 volunteers have been logged. There is much still to learn regarding the distribution and ecology of Maine's herpetofauna, and we encourage members of the public to share their photo-documented observations by submitting a MARAP reporting form, available on MDIFW's website in the Species Information section. **Please submit observations of any of the four state-listed reptiles -- Eastern Box Turtle (Endangered), Blanding's Turtle (Endangered), Spotted Turtle (Threatened), and Black Racer (Endangered) – as soon as possible to MDIFW (phillip.demaynadier@maine.gov or call 207-941-4239).**

For more information on research, assessment, and conservation efforts for Maine's rare amphibians and snakes, see most recent annual reports here: http://www.maine.gov/ifw/wildlife/reports/research_management.html, or visit RAI Group's reptile and amphibian webpage here: <http://www.maine.gov/ifw/wildlife/species/reptiles/index.html>.

This work is supported by volunteer assistance, the federal State Wildlife Grants program, and state revenues from the Loon Conservation Plate and Chickadee Check-off funds.

--Beth Swartz and Phillip deMaynadier

Rare Turtles

For nearly 20 years, MDIFW has actively researched the distribution and status of Blanding's and Spotted Turtles in Maine. Blanding's Turtles (Endangered) are 7 to 10 inches long with a yellow throat and light colored flecking on a helmet-shaped shell. Spotted Turtles (Threatened) are 5 to 6 inches in length, have yellow spots on the head, tail, and legs, and a somewhat flat, yellow-spotted shell. Both species are semi-aquatic preferring small, shallow wetlands in southern Maine, including pocket swamps and vernal pools. Undeveloped fields and upland forests surrounding these wetlands provide habitat for nesting, aestivating (a period of summer inactivity), and movements between wetlands.

Despite the attention these turtles have received, habitat loss and fragmentation continue to threaten both species' persistence in Maine. As the human population expands, road mortality becomes an ever increasing threat. The turtle's shell has provided sufficient protection from predators for millions of years, but unfortunately is no match for

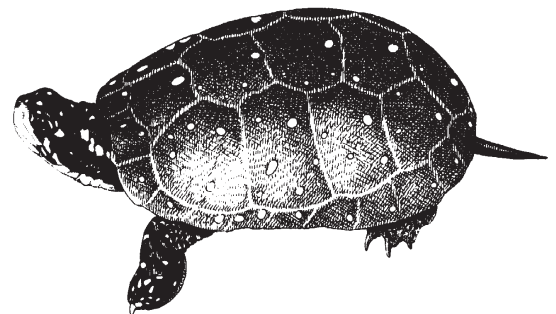

a car tire. Both Blanding's and Spotted Turtles are long-lived animals that take a minimum of seven (Spotted) to 14 (Blanding's) years to reach reproductive age. This, coupled with low hatching success, places increased importance on adult survivorship. Recent population analyses of several freshwater turtle species indicate that as little as 2–3% additive annual mortality of adults is unsustainable, leading ultimately to local population extinction. In other words, losing just a few breeding adult turtles each year to road-kill may be the greatest factor threatening the persistence of Blanding's and Spotted Turtles in Maine.

MDIFW is currently involved in three active conservation projects benefitting Blanding's and Spotted Turtles in Maine:

- *Cautionary Road Signage Project (Turtle X-ing)*: A cooperative study by the University of Maine and MDIFW identified high-density rare turtle areas with road-crossing hotspots. With the assistance of the Maine DOT, The Nature Conservancy, and local towns, temporary yellow warning signs were installed in strategic locations to alert motorists to the possible presence of turtles on the roadway. The signs are deployed seasonally, coinciding with the period when overland turtle movements are greatest, thus helping to maximize the signs impact by reducing "sign fatigue" by local commuters. This project is now in its 8th year.
- *Conservation of Blanding's Turtle in the Northeast*: MDIFW along with four other Northeastern states were awarded a Competitive State Wildlife Grant to develop a regional model and plan for Blanding's Turtles. This work, including a genetic assessment facilitated through Dr. Rhymer at the University of Maine, began spring 2012 and was completed in 2013. To date, Maine biologists have systematically surveyed 18 Blanding's turtle sites, spanning 12 towns, and obtained almost 60 genetic samples for population analysis.
- *Wildlife Road Watch*: Partnering with Maine Audubon and Maine DOT, a volunteer initiative to report wildlife-road interactions (both alive and dead) was launched in 2010. Data generated from this project may help in planning future projects and identifying mitigation efforts (e.g., additional signage areas, critter crossings, exclusionary fencing). In addition to incidental sightings, participants may also choose to adopt a road segment for repeated monitoring. For more information on the Wildlife Road Watch, please visit: <http://www.wildlifecrossing.net/maine>.

This work is supported by volunteer assistance, The Nature Conservancy, the federal State Wildlife Grants program, and state revenues from the Loon Conservation Plate, Chickadee Check-off funds, the Maine Outdoor Heritage Fund, and the Maine Department of Transportation.

--Derek Yorks and Jonathan Mays

Invertebrates

Stalking Rare Damsels and Dragons: The Maine Damselfly and Dragonfly Survey

Insects in the Order Odonata, damselflies and dragonflies, are a conspicuous component of Maine's wildlife diversity. Presently, 158 species have been documented in the state, comprising nearly 36% of the total North American fauna. Several of Maine's odonate species are of national and global conservation concern. Maine currently lists three species as Endangered or Threatened and 25 species as Special Concern. While several odonates are highly sensitive to freshwater habitat degradation, baseline information for the group had been lacking in Maine, until recently.

In 1998, MDIFW initiated the Maine Damselfly and Dragonfly Survey (MDDS), a multi-year, citizen-science atlasing initiative designed to improve our knowledge of the distribution, status, and habitat relationships of damselflies and dragonflies statewide. In addition to accumulating a tremendous amount of scientific data, the MDDS engaged over 200 of Maine's non-game enthusiasts and raised public awareness of invertebrate conservation generally. Some of the more significant contributions by the survey, from among the 17,000 new records submitted, included 10 new state species records and two new U.S. national records (the Quebec Emerald and Canada Whiteface dragonflies).

With the volunteer atlasing component of the MDDS project now completed, MDIFW is working with Paul M. Brunelle, an odonate expert and graphic design artist from Nova Scotia, to assist with authoring and designing the project's capstone product: *An Atlas and Conservation Assessment of Acadia's Damselfly and Dragonfly Fauna*. Populated largely with data contributed by MDDS volunteers, this atlas will serve as the first authoritative publication on the distribution and natural history of odonates from Maine and the Canadian Maritime Provinces.

Funding for this work comes from volunteer assistance, the federal State Wildlife Grants program, U.S. Environmental Protection Agency, and state revenues from the Loon Conservation Plate, Chickadee Check-off funds, and the Maine Outdoor Heritage Fund.

--Phillip deMaynadier

Arrowhead Spiketail Dragonfly

The Arrowhead Spiketail (*Cordulegaster obliqua*) is a large dragonfly with a distinctive yellow "arrowhead" abdominal pattern. The species is most often found patrolling small, first-order forested streams. These streams serve as reproductive habitat, as the females deposit eggs into the substrate, and larvae then spend several years in the stream,

feeding and growing, before emerging as adults. While the species is found across much of the eastern U.S., it is comparatively rare throughout its range and, until recently, known from only nine sites in Maine. This elusive dragonfly is currently listed as a species of Special Concern.

A collaborative research project between University of Maine and MDIFW has been undertaken in 2013 to better understand the distribution and habitat needs of this rare dragonfly. Species surveys were conducted at approximately 12 waterways in York County that were believed to be suitable habitat, resulting in four new Spiketail occurrences. These surveys also identified other headwater stream dragonflies that co-occur with the Arrowhead Spiketail. An array of habitat data documenting stream characteristics and plant communities, along with remote GIS mapping data, will be used to better characterize reproductive habitat, which is poorly defined at present. Increasing our biological knowledge of the Arrowhead Spiketail will help inform future listing status and potential conservation needs for the species.

Funding for this work comes from the University of Maine, the federal State Wildlife Grants program, and state revenues from the Loon Conservation Plate and Chickadee Check-off funds.

--Jen Raber and Phillip deMaynadier

The Maine Butterfly Survey: Keeping Track of Scaled Jewels

Hessel's Hairstreak, Purple Lesser Fritillary, and Crowberry Blue are just some of the state's rarest butterflies that are both colorful in name and on the wing. In an effort to improve our knowledge of these and other priority butterflies, MDIFW is actively studying the group during statewide regional surveys. Attractive, conspicuous, and ecologically important, butterflies have garnered increasing attention from scientists and the general public as sentinels of habitat change. By documenting the distribution and status of the state's butterfly fauna, MDIFW hopes to improve its understanding of the group and prioritize conservation efforts towards those species most vulnerable to decline and potential state extinction.

In support of this goal, MDIFW received a grant from the Outdoor Heritage Fund in 2002 to contract a professional lepidopterist, Dr. Reginald Webster from New Brunswick, to help assemble a comprehensive assessment of the state's butterfly fauna. Drawing from published literature and specimen records located in museums and amateur collections throughout the Northeast, Reggie helped MDIFW develop the first baseline atlas and database of Maine's butterfly fauna – an essential step toward conservation of the group. The baseline atlas project compiled nearly 9,000 records and added 11 previously undocumented butterflies to the state list, which now stands at 121 species. Of special note is the relatively high proportion (~20%) of Maine butterflies and skippers that are extirpated (5 species) or state-listed as Endangered, Threatened, or Special Concern (19 species), which is a pattern consistent with global trends elsewhere for the group. Contact MDIFW to receive an updated checklist of the butterflies of Maine (phillip.demaynadier@maine.gov) or visit <http://mbs.umf.maine.edu/Publications.htm> to download a pdf copy of Maine's first baseline butterfly atlas.

Finally, we are pleased to announce that a statewide volunteer butterfly atlas took flight in 2007. Sponsored by MDIFW, in partnership with the University of Maine at Farmington (Dr. Ron Butler), Colby College (Dr. Herb Wilson), and Dr. Reginald Webster of New Brunswick, the Maine Butterfly Survey (MBS) is a multi-year, statewide, volunteer survey effort. Following in the tradition of previously successful state-sponsored wildlife atlasing projects, including the Maine Damselfly and Dragonfly Survey, data generated from the MBS comes primarily from trained citizen scientists. The survey will help fill information gaps identified during the baseline assessment on butterfly distribution, flight seasons, and habitat relationships for one of the state's most popular insect groups. To become involved in this project, or to learn more about Maine's butterflies, contact the volunteer coordinator, Dr. Herb Wilson, at whwilson@colby.edu, or check the MBS website at: <http://mbs.umf.maine.edu>.

Funding for this work comes from volunteer assistance, The Nature Conservancy, the federal State Wildlife Grants program, and state revenues from the Loon Conservation Plate, Chickadee Check-off funds, and the Maine Outdoor Heritage Fund.

--Phillip deMaynadier

Butterflies Unique to Maine

Of the 19 species of butterflies state-listed as Endangered, Threatened, or Special Concern, two stand out because they occur nowhere else but here in Maine or very nearby. The Katahdin Arctic (Endangered) is a subspecies of the Polixenes Arctic, which occurs in the arctic tundra from Alaska through northern Canada to Labrador. The Katahdin subspecies, however, is found nowhere else on earth, but the summit of Mount Katahdin in Baxter State Park. This medium-sized, drab-brown butterfly lives a harsh life on the windy, treeless boulder fields above 4,000 feet of elevation. It is often difficult to observe, flying only during calm days in July when females lay their eggs on alpine sedges – the larval host plant.

The life history of the Katahdin Arctic is not well documented. Its population size is unknown, but significant annual fluctuations are often observed, perhaps due to climatic conditions. Each summer, when and if weather conditions are

favorable, Baxter State Park staff monitor the population and keep watch for signs of concern. One potential threat to the butterfly is damage to its host plants and fragile alpine habitat when hikers walk off marked trails. Another is illegal collection of adults, which has happened on a few occasions in the past. Of greatest concern perhaps is the potential for alpine plant communities to be altered over time by climate change, leaving the Katahdin Arctic with no suitable habitat refuge to persist in the future.

Maine's second unique butterfly is the Clayton's Copper (Endangered). This small, orange-brown butterfly is thought to be a subspecies of the more common Dorcas Copper, found across much of northern and western North America. However, Clayton's Copper is known only from a handful of sites in Maine and New Brunswick (Figure 6), where it is found only in association with its larval host plant, the shrubby cinquefoil. This uncommon shrub grows best in circumneutral fens (peatlands rich in calcium carbonate or limestone) – a rare habitat type in Maine. Only a few of these sites host cinquefoil stands large enough to support viable populations of Clayton's Copper, and not all sites with cinquefoil are occupied by the butterfly. Of the nine sites where Clayton's Copper is found in Maine, only 3-4 host relatively large populations – the remainder are small and limited to a few acres or less of host plant.

Compared to the Katahdin Arctic, we know much more about the Clayton's Copper's life history and conservation status. Since 2007, MDIFW has partnered with researchers at the University of Maine to investigate the butterfly's taxonomy, genetics, habitat use, and population dynamics. We now have estimates for population size, flight period, and cinquefoil patch size at each colony, as well as a better understanding of the conservation importance of each site. We know more about the hydrologic and vegetative characteristics of the peatlands where the butterfly is found and how they compare to those where it is absent. And we have genetic information that shows three distinct and geographically separated population clusters in Maine. All of this information will help MDIFW monitor the butterfly's habitat and population status into the future to ensure it remains a part of our natural heritage.

Funding for this work comes from volunteer assistance, the federal State Wildlife Grants program, and state revenues from the Loon Conservation Plate and Chickadee Check-off funds.

--Beth Swartz

Rare Mayflies

Mayflies, or "shadflies" as they are often called, are a diverse group of insects with over 160 species found in Maine. Some species inhabit lakes and ponds, but most live in the flowing waters of our many streams and rivers. Belonging to the Order "Ephemeroptera" – named for the short lifespan of the winged adults – mayflies spend nearly their entire lives underwater, where they play a significant role in the food webs of aquatic ecosystems. Often abundant, the nymphs are a major consumer of algae and decomposer of plant material and, in turn, provide a high quality food source for many more visible stream predators. Anglers have long recognized that a good mayfly stream is likely a good trout and salmon stream as well. The most popular "flies" tied by fly-fishers to mimic their quarry's natural prey are modeled after the different life stages of the mayfly.

While most of Maine's mayfly species are widely distributed and relatively common, some are much rarer. Maine currently lists one species of mayfly as Endangered, one as Threatened, and 13 as Special Concern. The Roaring Brook Mayfly (Endangered) holds the distinction of being among the rarest in the world. For many years, it was only known from a single adult specimen collected on Mt. Katahdin in 1939, until surveys conducted by MDIFW in 2003 confirmed the species was still present on the mountain. Since then, MDIFW has surveyed approximately 160 streams and documented a total of 14 where the mayfly occurs. All of these sites are clustered in the mountains of central and western Maine (Figure 7). Other researchers have also collected

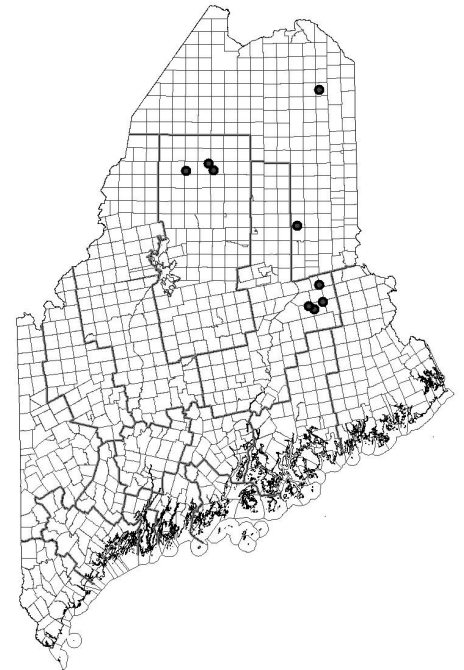

Figure 6. Distribution of Clayton's Copper in Maine.

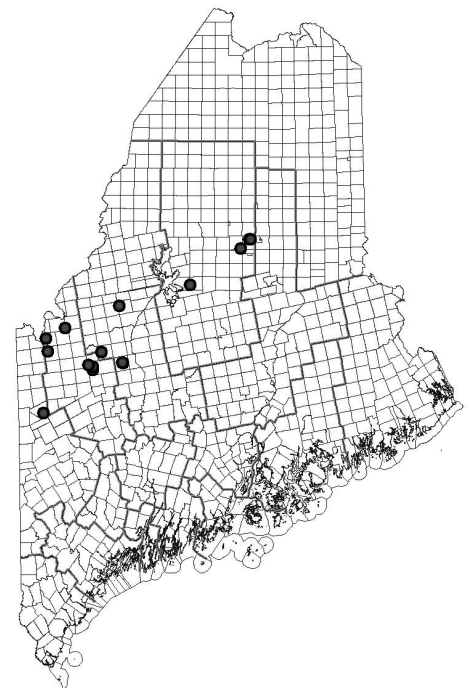

Figure 7. Distribution of Roaring Brook Mayfly in Maine.

a specimen in the Green Mountains of Vermont and another in the White Mountains of New Hampshire. While we now know the Roaring Brook Mayfly is not confined just to Mt. Katahdin, it does appear to be New England's only endemic mayfly - restricted to cold, undisturbed, high-elevation streams of the northern Appalachian Mountain Range.

The Tomah Mayfly, listed as Threatened, is a unique insect once thought to be extinct. It was rediscovered in Tomah Stream (Washington County) in 1978 and has since been documented at about 20 sites distributed across northern, eastern, and central Maine, and at least one site in New York. The nymphal stage of the Tomah Mayfly, unlike other species of mayflies, is carnivorous - preying largely upon other mayfly nymphs. This species depends on highly productive, seasonally-flooded, sedge meadows along large streams or rivers to complete its life cycle. Although sedge meadows are not an uncommon habitat type in Maine, the Tomah Mayfly is known only from a limited number of potential sites.

In addition to these two species, 13 other mayflies are considered Special Concern in Maine. Many of them are only known from one or two sites, but comprehensive surveys have never been done. As part of the Department's ongoing surveys for rare species, MDIFW continues to look for new occurrences of these uncommon insects in order to better understand their status and conservation needs.

Funding for this work comes from the federal State Wildlife Grants program and state revenues from the Loon Conservation Plate and Chickadee Check-off funds.

--Beth Swartz

Rare Freshwater Mussels

Freshwater mussels are relatively sedentary, bottom-dwelling invertebrates found in most of Maine's lakes, ponds, rivers, and streams. Often referred to as a "clam," the freshwater mussel's inconspicuous and seemingly drab lifestyle belies its importance. As filter-feeders, mussels provide a vital service to aquatic environments by filtering suspended particles such as algae, bacteria, and detritus from the water. While an individual mussel can filter only a small amount of water in a single day, a thriving mussel community filters and cleans millions of gallons of lake or river water every day – a service they provide to us cost-free!

Because they constantly filter large volumes of water, reside in the benthic substrate, can't leave their surroundings, and live a long time, freshwater mussels are sensitive to contaminants and changes in their environment. Consequently, they are one of our most valuable indicators of water quality and aquatic ecosystem health. They are also one of the most imperiled groups of animals in the country. Of the nearly 300 species of freshwater mussels found in the United States, more than a third have already vanished or are in danger of extinction, and over 75% are listed as Endangered, Threatened, or Special Concern by various states. These dramatic declines have been caused largely by the degradation and loss of mussel habitat from pollution, dams, and the channelization and sedimentation of once clean, free-flowing rivers and streams. In some parts of the country, the accidental introduction of a prolific foreign competitor, the zebra mussel, is also jeopardizing many populations.

Maine's freshwater mussel fauna has fared relatively better than that of many states. We have not lost any species, our freshwater habitats are reasonably clean, and the zebra mussel has not yet found its way into our waterways. However, we are not immune to the problems of habitat loss and degradation that have eliminated populations and extirpated species in other parts of the country. Of our 10 native species (Table 13), three – the Yellow Lampmussel, Tidewater Mucket, and Brook Floater – are currently listed as Threatened under the Maine Endangered Species Act. Fortunately, compared to most states within the range of these species, Maine hosts some of the best remaining populations and may be a last stronghold for these rare mussels.

Table 13. Freshwater Mussels of Maine.

Eastern Pearlshell (<i>Margaritifera margaritifera</i>)	
Eastern Elliptio (<i>Elliptio complanata</i>)	
Triangle Floater (<i>Alasmidonta undulata</i>)	
Brook Floater (<i>Alasmidonta varicosa</i>)	THREATENED
Eastern Floater (<i>Pyganodon cataracta</i>)	
Alewite Floater (<i>Anodonta implicata</i>)	
Creeper (<i>Strophitus undulatus</i>)	SPECIAL CONCERN
Yellow Lampmussel (<i>Lampsilis cariosa</i>)	THREATENED
Eastern Lampmussel (<i>Lampsilis radiata radiata</i>)	
Tidewater Mucket (<i>Leptodea ochracea</i>)	THREATENED

During the past year, MDIFW has continued to work closely with the Penobscot River Restoration Trust (PRRT) to ensure that impacts to rare mussels residing in the impoundments behind Great Works and Veazie Dams are minimized when the dams are removed and the impoundments drained back to a narrow river channel. During the summer of 2012, PRRT and MDIFW coordinated the recovery and relocation of approximately 800 Yellow Lampmussels and Tidewater Muckets that would have otherwise died when the Great Works Dam was removed. As part of the Incidental Take Permit granted to the Trust by MDIFW, PRRT will be monitoring the survival of the relocated animals for two years and also investigating how mussels respond to the change in their environment from an impounded to free-flowing system. This will help MDIFW document the effectiveness of hands-on recovery efforts for rare freshwater mussels. It also could provide a

better understanding of the effects of dam removal on Maine's rare freshwater mussel species. While habitat should improve for the Brook Floater, the outcome for the Yellow Lampmussel and Tidewater Mucket is less certain, since they seem to do well in impoundments. With proposals to remove hydropower dams increasing in Maine, the Penobscot River Restoration Project is an important opportunity to learn more about how river restoration might affect the status and long-term conservation of these rare mussels.

During the past two years, we also have focused on intensively surveying streams and rivers where the State-Threatened Brook Floater has been documented. Many of these sites have not been visited in decades, and very little, if anything, is known about the species' current status at each. MDIFW has contracted Ethan Nedeau (Biodrawiversity LLC), an expert with tremendous experience, to conduct surveys for the Brook Floater. So far, Ethan has surveyed nine rivers and found some interesting results. At Maine's only southern occurrence, the Pleasant River in Cumberland County, Ethan found that severe erosion and sedimentation likely caused by adjacent land use have nearly extirpated the Brook Floater in that river. In the St. George River, where IFW always presumed the population was healthy based on numbers observed, Ethan found only old individuals with little evidence of reproduction. Conversely, sites like Kenduskeag Stream, Marsh Stream and the Passadumkeag River appear to have relatively large, stable populations. At each site visited, Ethan is documenting the Brook Floater's population density and size, as well as habitat use and potential threats. He will be surveying three more rivers in 2013. This information will be an invaluable contribution to a regional assessment of the Brook Floater's conservation status, which MDIFW is participating in with several other northeastern states.

More information on Maine's mussels can be found in *The Freshwater Mussels of Maine* (Nedeau et al. 2000), available through the Department's online store (<http://www.mefishwildlife.com/>) or Information Center (207-287-8000).

Funding for this work comes from volunteer assistance, the federal State Wildlife Grants program, and state revenues from the Loon Conservation Plate and Chickadee Check-off funds.

--Beth Swartz

Special Habitats for Reptiles, Amphibians, and Invertebrates

Freshwater Marshes and Shrub Swamps

Freshwater marshes and shrub swamps are open, vegetated, shallow wetlands that contain water most of the time. They may vary tremendously in size and appearance, but they are all characterized as sun-soaked places with standing water and abundant vegetation with high levels of biological production. Many of Maine's amphibians, reptiles, and invertebrates depend on these wetlands for all or some of their life cycle. Frogs, including Leopard Frogs (Special Concern), Pickerel Frogs, Green Frogs, Bull Frogs, Mink Frogs, Grey Tree Frogs, and Spring Peepers, breed and often live in these habitats year-round. The mixture of lush herbaceous vegetation found above and below the water surface provides amphibians with shelter from predators, as well as food in the form of the vegetation itself or by supporting a plethora of invertebrate prey. A number of reptile species thrive in marshes and shrub swamps too. Spotted Turtles (Threatened), Blanding's Turtles (Endangered), Painted Turtles, and Snapping Turtles are found in these wetlands, as are Ribbon snakes (Special Concern), Garter snakes, and Northern Water Snakes. Marshes and shrub swamps are also hugely important to a number of invertebrates, perhaps most conspicuously dragonflies and damselflies. Across Maine's forest-dominated landscape, these wetlands are often focal points for wide-ranging wildlife in an area. Beyond reptiles, amphibians, and invertebrates - wading birds, waterfowl, beaver, and even moose depend on these productive habitats.

The recent assessment and planning efforts focused on Blanding's turtles in Maine, through the Competitive State Wildlife Grant (U.S. Fish and Wildlife Service), has been informative in highlighting the special importance of marshes and shrub swamps for this rare species. While Blanding's turtles are known to use a number and variety of wetlands, even in a single season, they are not found in just any wetland. High value marshes and shrub swamps are often at the core of their home ranges, generally serving as overwintering and late summer feeding areas. Information that has been gathered from this project will help Maine biologists to understand what specific characteristics of marshes and shrub swamps are critical for the survival of this species in the state.

Funding for MDIFW's efforts in research and conservation of marshes and shrub swamps for Blanding's turtles and other herpetofauna comes from the federal State Wildlife Grants program and state revenues from the Loon Conservation Plate and Chickadee Check-off funds.

--Derek Yorks

For more information on other rare invertebrate species, such as tiger beetles, and key habitats, such as Riparian Sedge meadows, Vernal Pools, and Pitch Pine Woodlands and Barrens, see our most recent annual reports here: http://www.maine.gov/ifw/wildlife/reports/research_management.html, or visit RAI Group's invertebrate webpage here: <http://www.maine.gov/ifw/wildlife/species/invertebrates/index.html>.

FISH CONSERVATION AND MANAGEMENT

Brook Trout Stream Habitat: It's All About Access and Diversity

Maine's wild brook trout (*Salvelinus fontinalis*) thrive in clean, cool, well-oxygenated stream systems. These conditions are relatively common to intact, stable, mature woodlands that stabilize riparian area soils, provide shade, protect water quality, create cover elements, and contribute to overall aquatic habitat diversity. However, many Maine stream habitats are suboptimal for wild trout because of a history of degradation by human land-uses, often associated with log driving or improper culvert installations of the past.

Brook trout prefer slightly different habitat features depending on their size, age, or time of the year. Juvenile fish tend to prefer shallow, well-oxygenated riffle areas whereas larger, older fish prefer deeper water and pool habitats with ample cover elements. Trout in spawning condition move to areas of well-oxygenated, loose gravels in the fall, but, at other times of the year, these same fish will use areas with more cover, greater food resources, or cooler water conditions. In other words, wild trout thrive in areas where habitat features are diverse and they can freely move to different areas as stream conditions naturally fluctuate. Hence, a key piece to managing wild, stream-dwelling brook trout is assuring that ample diverse, quality habitats exist and are accessible as needed.

A History of Habitat Degradation

As settlement and development increased over the past three plus centuries, so did the active removal of trees, wood debris, and boulders from the state's waterways. In many streams, dams were built to assist with driving logs to mills. Strategic opening of the dams resulted in a large torrent of logs and water that scoured the streambed and removed wood, boulders, gravel, and other material from the stream channel and riparian areas. Historic logging and agricultural practices also removed trees to the edge of the stream, limiting natural wood input to the stream. In some cases, streams were deliberately bermed or cleared of wood and boulders to improve navigation or facilitate the driving of logs (Figure 8). Over time, these and other activities resulted in depletion and degradation of habitat for Maine's cold-water fish, including brook trout. The removal of in-stream features altered channel form, stream flow, and how wood, boulders, rock, and gravel moved through the river system. Although these actions were largely eliminated decades ago, the result is extensive stream networks lacking optimal, or sometimes even adequate, fish habitat conditions. Persistent blockages to fish movements remain (Figure 9).



Figure 8. Birch River, Eagle Lake, 1954. Historic log driving practices included bulldozing and berming stream channels. This led to channelization and simplification of stream habitats.



Figure 9. Thirty-five Brook, Narraguagus River drainage. Note the over widened, straightened, and shallow channel and lack of habitat complexity, wood, or other cover elements. Photo Credit: Ben Naumann.

A Variety of Treatment Options

Stream habitat restoration is expensive, technically challenging, and often compromised by existing infrastructure within or proximal to degraded streams. However, a variety of options exists and are being implemented when it is determined that habitat restoration will likely improve conditions for wild trout and that risks are minimal. Habitat restoration strategies that benefit wild brook trout tend to fall within two categories: 1) improving stream network connectivity to enhance fish movement capability, or 2) increase instream habitat diversity to provide habitat type and condition options for trout as biological needs shift due to varying environmental conditions or life history aspects. Many projects are undertaken to remedy degradation resulting from past log driving or other land use practices that resulted in overwidened stream channels that are devoid of habitat diversity, especially pools. Wood addition, or often called 'chop and drop', projects are

often undertaken to moderate flashy flows, reduce sediment transport, increase cover elements, and to generally improve brook trout habitat by increasing and retaining organic matter inputs and assisting with creating or enhancing pools. The most common treatment strategy is to facilitate pool formation and persistence that benefits brook trout by serving as temperature and cover refuge during summer and winter low flows. V-shaped rock weirs create large pools – in the order of 2-4 feet deep – whereas other treatments, including paired boulders, coarse woody debris, and rock vanes, create smaller pools.

Examples of Habitat Restoration

Fish passage: Marshall Brook

Marshall Brook is a relatively small coastal stream system of about 3,200 acres on Mount Desert Island (MDI), Maine. Most of the watershed lies within Acadia National Park. The sea run brook trout, 'salters' of coastal Maine, have always been a popular and storied fishery, but recent coastal survey efforts seem to support local, anecdotal declines of coastal populations of wild brook trout. Acadia National Park (ANP) and MDI continue to remain a stronghold for these popular recreational fisheries. Marshall Brook maintains a population of anadromous brook trout although true sea-run fish are likely restricted to the mainstem reach below two known fish passage barriers. The road/stream crossings with the Seal Cove Road are poorly designed, undersized, and chronically problematic for the town. Because of the small culverts, local flooding at this site occurs often during periods of heavy rain, which can result in property damage to the town. Local residents, the Town of Southwest Harbor, ANP, and MDIFW have been working cooperatively to restore connectivity through the extent of Marshall Brook from headwaters to the Bass Harbor estuary. ANP is replacing culverts at 4 sites on tributaries and headwaters within the Marshall Brook system. MDIFW, the Eastern Brook Trout Joint Venture (EBTJV), and the National Oceanic and Atmospheric Administration (NOAA) are assisting the Town of Southwest Harbor with funding assistance and technical support for replacing the existing undersized culverts with much larger, ecologically sound, embedded concrete boxes to improve fish passage and stream connectivity. The East Branch crossing was replaced in 2012 (Figures 10 and 11) and the West Branch crossing is currently under construction. The goal is to return the Marshall Brook system to free-flowing condition from headwaters to the estuary by 2015 and we are well on our way!



Figure 10. The upstream side of East Branch Marshall Brook with the Seal Cove Road crossing prior to replacement. Photo Credit: Merry Gallagher.



Figure 11. The upstream side of the same crossing after replacement. Photo Credit: Merry Gallagher.

Large Wood Addition: Chop and Drop at Mule Brook

We have been working quite extensively with many partners and landowners to improve trout habitat through a technique called 'chop and drop'. Chop and drop projects are cooperative efforts between foresters and biologists where certain riparian area trees are strategically felled into a stream channel to enhance local fish habitat conditions. Wood addition provides many benefits to trout – the trees provide cover elements, often become sites of increased insect density, and often divert stream flows that contribute to pool scouring and persistence. This technique is becoming more widespread in other states, as well as Maine. However, not all sites are appropriate candidates for wood addition because the wood will move through the system subsequent to high flow events as it collects and anchors as jams.

Mule Brook, in T10R10, was heavily log-driven in the past and displays the chronic over-widened, lack of pools, and in-stream cover condition that is common to previously driven streams (Figure 12). As part of a cooperative project with the Maine Forest Service and the landowner, wood was strategically added in Fall 2010 (Figure 13). The MDIFW Fish Group has been monitoring brook trout response to this treatment in cooperation with the Maine Forest Service. Three sites along Mule Brook, one above the treated area, one within the wood addition area, and one below, have been annually electrofished since before wood was added in 2010. Subsequent to wood addition, the proportion of one year old and older brook trout has steadily increased each year in the treatment section.



Figure 12. Overwidened, shallow stream reach with little cover. Mule Brook prior to wood addition in 2010. Photo Credit: Merry Gallagher.



Figure 13. Mule Brook one year after wood addition. The large wood is stockpiling and scouring action underneath is already apparent. Photo Credit: Merry Gallagher.

Comprehensive Habitat Restoration: Intervale Brook

In most cases, stream habitat restoration requires multiple treatment options, applied simultaneously or in a concerted series, to be most effective for enhancing brook trout habitat condition. Because quality brook trout habitat incorporates both enhancing overall instream quality, as well as improving stream connectivity so that trout can move to other areas when necessary, often the best option for recovering stream habitat is some combination of improving cover and pool features, as well as enhancing fish passage at certain sites.

Intervale Brook is an approximately four mile long stream in Frenchtown Township with a past history of log driving. It was bulldozed, unnaturally straightened, and the banks were bermed to facilitate moving logs downstream to First Roach Pond. Intervale Brook also retains a rather robust log-constructed driving dam near the headwaters (Figure 14). This structure continues to be a complete barrier to fish movements. Intervale Brook maintains a moderate wild brook trout population, although physical habitat features are lacking. Plum Creek Timberlands, the landowner, has led the charge to improve habitat quality for trout in this stream as an experiment to assess the effects of various habitat restoration techniques.

This is a multi-year restoration project where, in 2012, boulders that were removed from the channel, and used in either berm construction or placed up on the banks, were returned to the channel. Various constructed berms down the length of the channel were opened to encourage additional meanders to the main flow path, as well as reconnect the stream to floodplain features and overflow channels. Where feasible, large trees in close proximity to the channel were pulled down into the channel to act as key pieces for future wood addition. These key pieces are larger than average-size trees in the area and also maintain a root-wad connection with the bank. The intent is for them to act as anchors for smaller-sized wood pieces that will be added later. In 2013, two to three miles of channel will be treated with chop and drop wood addition and the dam near the headwaters will be removed.



Figure 14. Remnant splash dam near the headwaters of Intervale Brook. This dam continues to be a barrier to fish passage and is scheduled for removal in Fall 2013. Photo Credit: Merry Gallagher.

The Fish Group has four monitoring stations along the length of the stream – one above the dam area that is above the effects of the treatments and was not bulldozed or bermed in the past. Two monitoring stations are within the proposed treatment area. A fourth station is downstream from any treatments and was bulldozed and bermed in the past. Data collection at all sites began in 2012, before any actions occurred in the treatment sections. Monitoring of these sites will continue for at least 5 years.

--Merry Gallagher
Research and Assessment Section, Fisheries Biologist

FISHERIES MANAGEMENT SECTION

Maine is blessed with over 5,800 lakes and ponds one acre or more in size, totaling nearly one million acres, and about 36,000 miles of rivers and streams. In the early 1950s, the Legislature and Maine's Inland Fisheries and Wildlife Department created the Fisheries and Hatcheries Division to manage this vast inland fishery resource, an asset that is now estimated to add over \$300 million annually to the state's economy. This Division is responsible for protecting native fish species and their critical habitats, while providing a diversity of opportunities for Maine's angling community. A staff of 24 fishery biologists in the Fisheries Section works from seven Regional Headquarters, Bangor, and Augusta to achieve these objectives.

Progressive fisheries management emphasizes the protection of native, self-sustaining populations, along with carefully considered stocking programs to maximize fishing opportunities in all areas of the state. Our Fisheries Section receives national acclaim for its efforts to protect native species, while making Maine a destination for serious anglers. Below are just a few examples of the work our fisheries biologists are conducting in support of this state's incredibly rich and diverse freshwater resources.

--Dave Boucher

Fisheries Management Section Supervisor

REGIONAL FISHERIES MANAGEMENT

Illegal Introduction of Largemouth Bass in the St. Croix River Drainage

In the spring of 2011, local Game Wardens received a report of an angler catching an adult largemouth bass in Grand Falls Flowage in eastern Washington County. This report was investigated but could not be substantiated by MDIFW Regional Fisheries Biologists. In May 2012, another angler reported catching an adult largemouth bass in Grand Falls Flowage, and this time the fish was kept and presented to Passamaquoddy Tribe and MDIFW biologists for positive identification. The fish was indeed a largemouth bass, and soon after, more largemouths were caught by other anglers in the same area. This confirmed that multiple adults were present in this section of the St. Croix River drainage (Figure 15), and that a spawning population might successfully colonize and expand their presence in the drainage.

Shortly after these initial confirmations, MDIFW biologists coordinated a survey effort with the Passamaquoddy Tribe and the Maine Warden Service to establish the distribution of largemouths, and to eradicate any possible concentrations of newly stocked fish in the areas where largemouths were reported by anglers. The Department's 18-foot electrofishing boat was used to sweep the area over a two-day period, but none were found.

Later that summer, a camp owner reported catching juvenile largemouth bass in a minnow trap at Grand Falls Flowage. Regional biologists responded and positively identified the fish as ½ to 1 ½ year-old largemouth bass. This collection confirmed that largemouth bass were successfully spawning in the St. Croix River drainage.

There is free and open access to many lakes connected to Grand Falls Flowage, as well as to the lower and upper main-stem parts of the river (Figure 16). Largemouths can easily move west into Lewy, Long, and Big Lakes, and possibly into West Grand Lake via Little River - West Grand Lake's second outlet. Largemouths can also expand quickly into the lower river below Grand Falls dam to Woodland Flowage, and to the lower reaches of the river all the way to Calais. The upper portion of the main-stem can be accessed through the fishway at the Vanceboro Dam to Spednic Lake.

A large portion of the drainage has been managed for quality smallmouth bass fisheries for many, many decades; these fish have supported premiere sport fisheries attracting anglers from all over the world. It's been estimated that the economic impact from smallmouth bass fishing in the St. Croix drainage is 5 to 6 million dollars annually. Estimated open-water angler use derived from aerial counts on Grand Falls Flowage and Big Lake was 3,670 +1,054 and 7,667 +1,909 angler days in 2003, with the predominate effort concentrated on smallmouth bass.

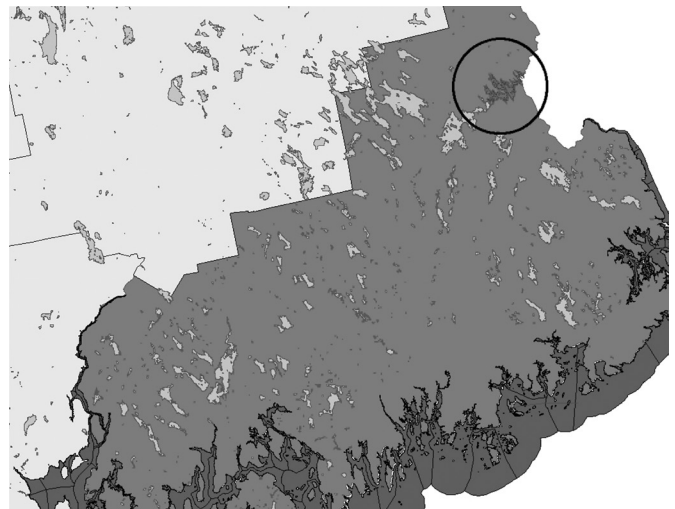

Figure 15. Grand Falls Flowage in the St. Croix River drainage Downeast in Region C (circled).

The introduction of largemouth bass could have a widespread and permanent negative impact on the fisheries in the main-stem and west branches of the St. Croix drainage. We anticipate that largemouths will compete extensively with smallmouths for food and space, particularly in waters where spawning and nursery habitat for largemouths is abundant and recruitment is expected to be high; rearing habitat for largemouth bass is abundant throughout much of this drainage. In addition, largemouth and smallmouth adult habitats overlap, and juveniles of both species will use the same nursery areas. In Grand Falls Flowage, spawning habitat for smallmouths is limited, so largemouths are expected to become the dominant bass species fairly quickly. There is also an important white perch population in Grand Falls Flowage, and we expect the fishery it supports will be negatively impacted by largemouths through extensive predation.

Other waters, such as Lewy Lake, Long Lake, Woodland Flowage, and the main-stem river both above Grand Falls and below Woodland Flowage, also provide extensive spawning and nursery habitat for largemouths. We can expect to see dramatic expansions of that species in those waters, and they could become the most abundant predator species.

Big Lake, just upriver of Grand Falls Flowage, has one of the highest concentrations of anglers fishing for smallmouths. Compared to many other waters in the system, this lake has extensive smallmouth rearing habitat and fewer areas suitable for largemouths. In recent years the lake has nonetheless experienced fluctuations in bass recruitment and angler catch rates. Additional fishing regulations may be needed to help stabilize and enhance this important smallmouth fishery. It is unclear how the future influx of largemouth bass will affect the smallmouth bass population in Big Lake.

Big Lake also has important fisheries for white perch and stocked and wild landlocked salmon. The lake's salmon populations rely heavily on resident rainbow smelts for forage. Salmon also drop down from Grand Lake Stream in the winter to feed in Big Lake before moving back into Grand Lake Stream in spring to feed and then again in the fall to spawn. Another predator in Big Lake, such as largemouths, will increase competition for forage and may affect the numbers and sizes of salmon and white perch available to anglers.

Unfortunately, there are no known strategies for eradicating largemouth bass, or for controlling their expansion in this large, biologically complex water system. MDIFW will closely track the migration of largemouths to other parts of the St. Croix drainage, and we'll diligently monitor their impacts to existing and highly valued sport fisheries.

--Greg Burr

Jonesboro Headquarters, Regional Fisheries Biologist

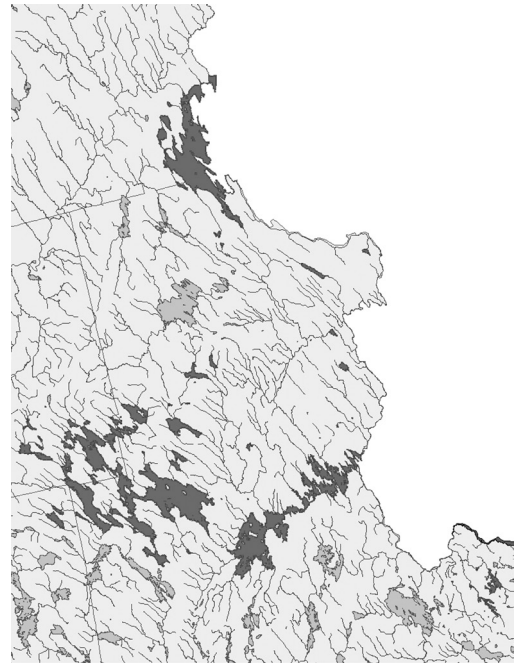

Figure 16. Waters naturally accessible to migrating largemouth bass.

Habitat Variables Influencing the Returns of Hatchery-reared Fall-yearling Brook Trout in Maine Lakes

MDIFW stocks over one million brook trout statewide annually at a substantial cost to the State's anglers. Considerable hatchery production is dedicated to the rearing of larger fall-yearling brook trout (FY-BKT), which are stocked in the fall and primarily into marginal waters with limited summer holdover potential. Most of these waters are nonetheless suitable for fall to spring survival, and thus provide popular fishing opportunities for Maine ice anglers. Given the considerable financial investment by MDIFW in providing a FY-BKT program, waters for stocking should be selected based on a specific suite of habitat criteria that promote the highest returns to anglers. Therefore, the goal of a recent study completed by MDIFW fisheries biologists was to investigate habitat variables that contribute most to the "catchability" of stocked FY-BKT.

Twenty-eight waters from fishery management regions A, B, and D were selected for analyses. Study waters ranged in size from 6 to 5,515 acres (average of 801 acres), and species richness (number of fish species) ranged from 5 to 25 species/study water. Average water depth was between 6 and 62 feet, whereas maximum water depth ranged from 10 to 180 feet. Adult loon density ranged from 0 to 0.038 loons/acre, and urban proximity ranged from 0 to 36.0 miles. The initial FY-BKT stocking density was from 0.2 to 24.8 BKT/surface-acre (average of 4.2 FY-BKT/acre). The average percentage of FY-BKT caught during the first full month of ice fishing was $13.6 \pm 5.9\%$.

Statistical analysis determined that water size, species richness, and maximum depth were the most important variables influencing FY-BKT returns to early winter anglers. Running averages based on percent returns were used to identify discrete threshold values (breakpoints) in habitat variables that marked precipitous declines in angler returns. Those threshold values were pinpointed at a water size of 100 acres, a species richness of 15 fishes, and a maximum water depth of 42 feet. Based on this research, we've recommended that MDIFW fisheries biologists adopt a tiered, decision tree system (see figure) by which lakes proposed for FY-BKT stockings are selected and evaluated. Lakes chosen based on these thresholds should enhance MDIFW's ability to allocate resources more efficiently and increase angler returns. Ultimately, the angling public will benefit by this focused approach to FY-BKT stockings.

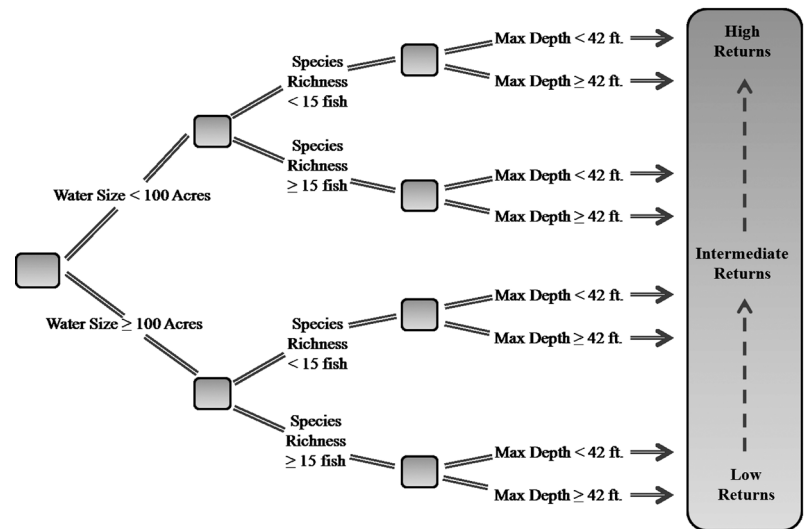

--Wes Ashe

Sidney Headquarters, Assistant Regional Fisheries Biologist

New Dry Mills Hatchery Education Building Will Fascinate and Inform Visitors of All Ages

In early June, Commissioner Chandler Woodcock officially opened the Dry Mills Hatchery Education Building, ushering in a new era in the 80-year history of the state's most popular fish hatchery.

The new Hatchery Education Building is an ideal complement to the Maine Wildlife Park, as it highlights the important work of the Department's Hatchery Division while informing visitors about eastern brook trout and the Department's stocking program.

The 16x20-ft post-and-beam wooden structure allows visitors to get up close to view and feed brook trout. At one end of the building, visitors can observe brook trout swimming in the two viewing tanks, each of which has a clear panel and is backlit to showcase a brook trout's vivid colors.

However, it is the 33-ft circular trout viewing pool that is becoming instantly popular, as visitors can get up close and view and feed the fish along the edge of the pool. The new pool holds approximately 6,000 brook trout. Interpretive signage informs visitors all about Maine's brook trout and the State's hatchery program.

The building dedication marks the culmination of over a year's worth of work by the Department's Engineering and Hatchery Divisions. Construction began with the removal of the old pool in the spring of 2012 and continued with the installation of the new circular pool and the educational building.

The building is a result of a partnership that includes donations from Hannaford-Delhaize Group, USO New England, Sebago Lake Rotary Club, F.E.T. Inc., and Evonik Cyro LLC. Funds from the Maine Outdoor Heritage fund and the Maine Sportsman Plate were instrumental in completing the pool, viewing area, and the Hatchery Education Building.

The Dry Mills Hatchery was originally constructed in 1933 by the Federal Works Project Administration. Not only does the hatchery produce approximately 90,000 brook trout annually, it supplies brook trout fry to the State's other hatcheries, and incubates approximately 1.2 million trout eggs annually. Over the course of the year, Dry Mills will stock over 170 waters in southern and western sections of the state.

The Department stocks, on average, approximately 1.3 million fish per year and raises brook trout, rainbow trout, brown trout, lake trout, splake, and landlocked salmon at the State's eight hatcheries. The Department stocks trout and salmon to provide anglers with fishing opportunities that would not otherwise be available.

--Mark Latti

MDIFW Promotional Coordinator

WILDLIFE MANAGEMENT SECTION

The regional wildlife management staff of biologists is best described as the Wildlife Division's wildlife generalists or the "jack of all trades". The seventeen wildlife biologists who staff the Department's seven regional field offices constitute the majority of the Regional Wildlife Management Section (WMS). Their breadth of knowledge, activities, and job responsibilities range far and wide - often requiring the regional staff to juggle numerous public requests, inquiries, and wildlife management projects at the same time. In essence, the regional wildlife biologist represents the Department in a multitude of public participation arenas and serves as the "state's wildlife expert" within their assigned regional geographic area. They are responsible for implementing the Wildlife Division's management program within those regions.

After reading the WMS overview, you'll probably agree that wildlife management work covers a wide spectrum of possibilities. However, much of what we do relates to managing or conserving specific habitat types and features. Since each species of wildlife has specific habitat requirements that can differ seasonally, we must ensure the proper balance and distribution of habitat types across the landscape if we are to maintain healthy wildlife populations. The Department addresses this issue every day using a variety of tools.

--John Pratte

Wildlife Management Section Supervisor

REGIONAL WILDLIFE MANAGEMENT

Wildlife Monitoring and Management

Biologists continue to monitor wildlife species trends and/or population densities and adjust for their management accordingly. For example, we monitor waterfowl nesting rates and use information to guide our hunting season dates and bag limits, which in turn reduces or increases waterfowl take by hunters. Another example is monitoring furbearer harvests by trappers and other data to then adjust trapping season lengths and bag limits.

Staff spend a significant amount of time collecting biological data from moose and deer, which are some of the key inputs into our management system. There is a good chance you brought your deer or moose to a tagging station, manned by department staff, where we took measurements and probably extracted a tooth. This also provides a great opportunity to interact with the public, answer questions, and learn more about your hunting experiences.

Wildlife Habitat Acquisition and Management

The WMS is charged with management of Wildlife Management Areas (WMAs), consisting of a myriad of habitat types and recreational opportunities: from backwater flowages supporting rare, threatened, and endangered flora and fauna, to dense softwood canopy cover used by deer during harsh winter stretches, to old-field and dense, young forest growth ideal for ruffed-grouse courting, nesting, and brood rearing. These same habitat provisions often provide ideal places for recreational activities to the hunter, fisherman, hiker, naturalist, photographer, and many other recreational user groups.

The main goal of the Lands Management Program is to provide optimal wildlife habitat based on species management plans and the objectives of the regional wildlife biologists. The program also provides for recreational access and activities of both the "consumptive" (i.e., hunting, fishing, and trapping) and "non-consumptive" (i.e., hiking, biking, horseback riding, etc.) uses. As can be expected, recreational opportunities on WMAs are a big benefit provided to the public. Recreational uses centered on wildlife recreation or supported by Department staff and lands such as hunting, fishing, wildlife watching, and motorsporting have dwarfed other recreational industries in Maine, providing about 2.4 billion dollars to the Maine economy annually. Anecdotal evidence in conversations and observations of activities on WMAs support this trend in recreational uses (http://www.beginningwithhabitat.org/about_bwh/maines_wildlife_legacy.html). Indeed, surveys conducted by the U.S. Fish and Wildlife Service indicate that, from 2001 to 2011, the number of hunters in Maine increased by about 10%, from 164,000 to 181,000, which mimics a national trend.

Environmental Review

One of the most important jobs of the Wildlife Management Section is reviewing development proposals to ensure that impacts to regulated wildlife habitats, as well as to endangered and threatened species, are identified and addressed. State and Federal environmental agencies, municipal governments, consultants, landowners, and businesses regularly ask regional biologists to assess the effect of development and changes in land-use on wildlife or wildlife habitats. Over an average year, WMS biologists provide 1,900 such assessments, as they worked with these various entities

to encourage land-use decisions that are sensitive to the habitat needs of wildlife. This is demanding and sometimes controversial work. Balancing the need to manage public wildlife resources, with the rights of individual landowners, requires thoughtful compromise and reliable information about where important resources occur.

While the number of requests has increased, the most notable change is the size and complexity of the projects staff are reviewing. We have seen a wave of new energy development technologies, some with massive federal subsidies, requiring staff to develop new review criteria and protocols to detect and measure potential wildlife impacts. We have also seen many project applicants request pre-application consultation meetings to incorporate wildlife needs/concerns during the project design phase, rather than after they submit a plan to LUPC or DEP. Just as the sophistication of project applicants and project design has increased dramatically, so has the Department, as we continue to update our wildlife habitat data using new resources and protocols to provide more accurate and consistent data to all project applicants.

Technical Assistance and Public Outreach

Maine has a variety of resources over a very large area. To add another layer of complexity, our wildlife have specific habitat requirements, and those habitats are most often owned by private and business interests. So, to further extend our efforts, reaching out to the public effectively is critical. We spend a significant amount of time helping landowners understand how their actions and efforts can benefit wildlife, often quite easily. Not only does this benefit wildlife, but also it provides more opportunity for us to enjoy these great resources. Staff attend forums throughout the year to listen to your concerns and hear what opportunities you would like improved. We also spend time helping the homeowner with a raccoon in the attic or the landowner with a culvert plugged by beaver.

--Wildlife Management Section Staff

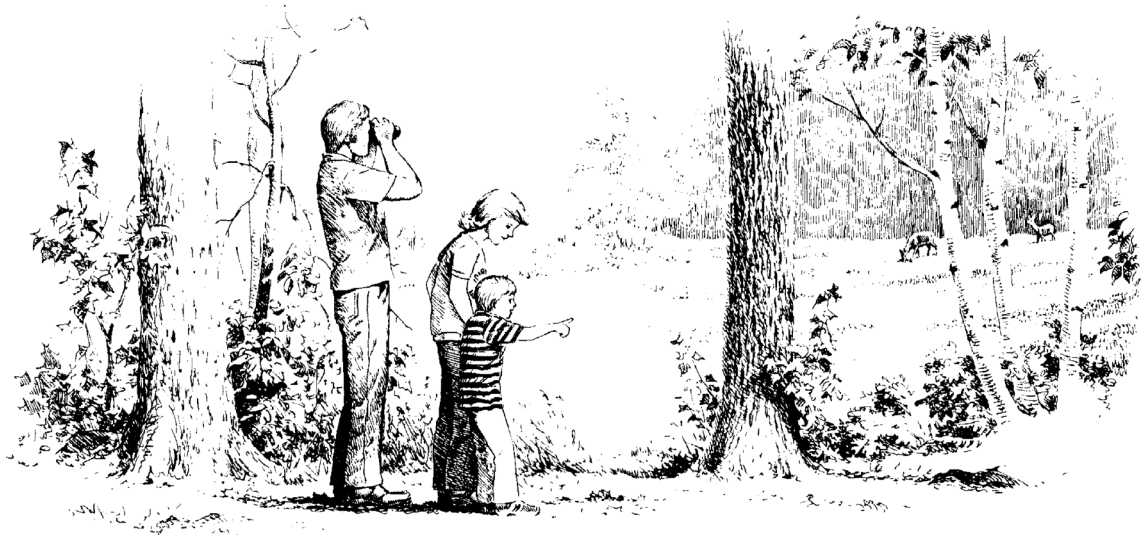

Managing Maine's Wild Turkeys

Regional wildlife biologists routinely resolve conflicts between humans and wildlife. Bears in the bird feeders, deer in gardens, and road culverts plugged by beavers are common complaints. We resolve these problems and conserve the wildlife whenever possible. Projecting loud noises is called "hazing" and can work if the person is both present and persistent. Removing the attraction or separating the animal from the attraction with a physical barrier is the preferred action in most instances. Sometimes moving the animal is a good option. Because wild turkeys are large, congregate in flocks, and operate only during daylight, they are easily seen and sometimes blamed for damage they don't cause. However, in the winter they can be a problem for dairy farmers if numbers around a farm become excessive.

Based on a public desire, in the late 1970s MDIFW wildlife biologists began restoring wild turkeys to their former range in Maine. Their size, resilience, and intelligence make them a popular and challenging species to hunt. They will forage on tree buds, like a grouse, but are primarily ground feeders. Winters can be stressful if snow depths exceed a foot. Cold temperatures and deep snow can force flocks of turkeys to exploit high value food calories found in the open corn silage bunkers of a dairy farm. The majority of turkey problems occur in the winter when insects are absent and natural vegetation is covered by snow. In winter, biologists have an edge over the adult wild turkey, which is wary and able to evade predation thanks to near-Superman vision. But hunger will force them to do things they normally wouldn't do, which is to bunch up on bait we place close to a highly visible live-trap.

This past winter, we tied our own capture record at a dairy farm south of Farmington by using a rocket net to catch 29 turkeys in one shot. As is our intention, this capture was dominated by adult hens and their young of the year. This strategy has three benefits. First, it removes the birds guilty of eating the silage. Second, it reduces the reproductive potential of the turkey population in the immediate vicinity of the farm. Third, birds not captured still experience the smoke and thundering explosion of the three rockets used to haul a 28' x 46' net through the air and down onto the flock on the bait. Those lucky to be outside the net's reach don't usually return that winter, or maybe ever.

The rocket net is housed in an amphitheater-shaped box and placed as close to the silage bunker as possible. The net is attached at three points to heavy pipe rockets charged with explosives. The rockets sit atop the box and are wired to the detonator, which is in the hand of a biologist hiding far away in a blind or a truck. The older and experienced birds view the net box as something out of place, scary, and a hiding place for predators. Initially, they have an aversion towards getting close. You see, not just Pilgrims like to eat turkeys. So, we bait the site for several days in a row in front of a lightweight replica box with fake rockets. A concentrated bait-pile forces them to be shoulder-to-shoulder, 10-12 feet in front of the box. We swap everything with the real gear the night before, so we are all set up just before daylight the next day.

This management tool has a secondary benefit. Captured birds are relocated to places where the hunting public wants a population established. The regional wildlife biologist in that area will identify willing large landowners for release sites. Since we have established a population in western Maine, our birds are being used to establish a population in Aroostook County.

Turkeys are an exciting species to hunt. It requires hiding, sitting, and calling. During the spring hunt (breeding season), male birds, called "toms", will readily return a hunter's call of a hen. The ensuing action makes turkey hunting a great way to introduce youths and young adults to the sport. Success rates in Maine are better than the average. Because access to private and public land is excellent, many consider the Maine turkey hunting experience to be world-class.

--Chuck Hulsey
Strong Headquarters, Regional Wildlife Biologist

Public Values Conserved by the Maine Department of Inland Fisheries and Wildlife

The Department is responsible for the fish and wildlife resources of the State, and, in doing so, has focused its efforts on the maintenance, promotion, and conservation of habitats of importance to those resources, as well as efforts focused on providing the citizens of the State access to enjoy those resources.

The Department has oversight of over 100,000 acres of wildlife habitats and seabird nesting islands, including some open water. All of these lands are open to public use and enjoyment. Active management of these lands is focused on the maintenance and provision of the highest quality wildlife habitat suited to any given site. In addition to managing the lands for wildlife habitat, public access onto these lands for traditional recreation uses is encouraged and promoted.

The following is a brief description of some of the values conserved by MDIFW for the citizens of the State of Maine:

Deer Wintering Areas: 6,500 Acres

Deer Wintering Areas (DWAs) are critical to the survival of white-tailed deer, especially in northern Maine, where snow is often very deep in winter. Much attention has been paid to these critical areas, where deer overwinter in mature softwood areas adjacent to adequate food sources. The Department actively looks to promote primary or secondary DWA cover, where appropriate, in all active management plans.

Native and Wild Brook Trout Waters: 334 Lakes, Ponds, and Streams

The ownership pattern of the Department has enabled conservation around portions of 334 lakes, ponds, and streams critical to native brook trout. Portions of these water bodies are permanently protected from habitat degradation, and provide anglers with many fishing opportunities.

Lake, Pond, and Stream Shoreline: 679 Miles

Nearly seven hundred miles of shoreline, which is important wildlife habitat for many species, has been conserved by MDIFW. These riparian areas – where uplands, wetlands, and open water meet – are a magnet for wildlife species for nesting, feeding, or travel. In addition to the habitat value, these shoreline areas are quintessentially Maine, and conserving these areas provides recreational opportunities that many citizens enjoy.

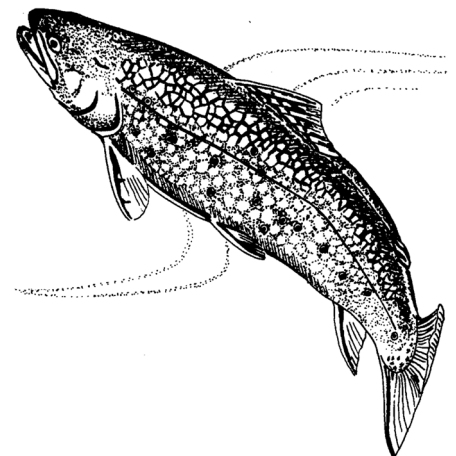

Seabird Nesting Island and Ledges: More than 300

Over 300 seabird nesting islands and ledges in the Coast of Maine Wildlife Management Area are conserved to provide nesting opportunities for these important species.

Early Successional Management: More than 14,600 Acres

Many wildlife species, like grouse and woodcock, are dependent upon early successional habitat. MDIFW maintains approximately 6,000 acres of its ownership in this successional stage, benefiting a whole host of other wildlife that use these habitats. Another 9,000 acres are currently comprised of early successional stages, and future management plans will incorporate these conditions into future active management practices. Over 1,400 acres of fields are maintained throughout the state.

Rare and Endangered Species and Natural Communities: 256 Site Occurrences

Owing to MDIFW's heavily-weighted ownership in southern and coastal Maine, where many of these species and communities exist, over 250 sites, where important natural communities or rare and endangered species have been documented, are conserved.

Hiking, Snowmobiling, and Other Trails: 329 Miles

Recreational trail opportunities are a critical component of the conserved lands throughout the State. Several hundred miles of trails and roads are open to many uses, with the main objective of providing access for hunting, fishing, and trapping. Smaller subsets of trails are identified for multiple uses, including ATVs and hiking. This infrastructure is critical to allowing appropriate use and access by the citizens of the state.



Water Access Sites: 140 Statewide

MDIFW owns and maintains 140 statewide water access sites, allowing for boaters, anglers, and others to enjoy the wide variety of lakes, ponds, streams, and rivers in the state.

The conserved public values, listed above, are a small sample of what the Department has been able to accomplish in its work to effectively and efficiently manage the fisheries and wildlife resources for the citizens of the State of Maine.

--Ryan Robicheau
Lands Management Biologist

TURKEY VIRUSES IN MAINE'S WILD TURKEY POPULATION

What you should know and do if you shoot a wild turkey that looks like this:



Turkey hunters should be aware of Lymphoproliferative Disease Virus (LPDV), which has been found in Maine turkeys, often associated with another virus called Avian Pox. Read below to find out more about the viruses and what to do if you shoot or see a turkey that has looks like the above pictures.

What is Lymphoproliferative Disease Virus (LPDV)?

This is a virus that causes lethargy and compromises the wild turkey's immune system. It is thought to spread between turkeys by direct skin contact. Some turkeys can fend off minor infections and survive, while others can develop lesions, often associated with Avian Pox, that inhibit their sight and ability to eat, which ultimately leads to death.

What is Avian Pox virus?

This is a virus that causes minor to extreme lesions on a turkey's head and legs. It is spread between turkeys by direct skin contact or through mosquito bites.

Are there health risks for humans?

Both viral diseases pose no risk to human health. However, like all infections, caution is advised while handling a bird with LPDV and Avian Pox. There is a potential for secondary bacterial infections if birds are handled improperly. Thoroughly cooking the meat to an internal temperature of a minimum of 165°F is also advised.

What should I do if I shoot a bird that looks like this?

Although wild turkeys cannot pass these viruses on to humans, if you shoot a bird that looks like the above pictures, and you do not want to eat it, do NOT register it and please contact a Wildlife Biologist at one of the offices listed below or call the Department of Public Safety in Augusta at **(800) 452-4664** to be connected with a Game Warden. After examining the bird, the Department staff member will determine your eligibility to harvest another turkey.

Where did these viruses come from?

Little is known about the origin of LPDV in the United States. LPDV was first detected in domestic turkeys in Europe. The first confirmed case in the United States was in wild turkeys in Georgia in 2009. MDIFW confirmed Maine's first case of LPDV in April 2012. Avian Pox is a common virus that has been found in wild and domestic turkeys and chickens in other states. Currently, known cases occur virtually wherever wild turkeys are present. We speculate that a combination of a very good turkey production year in Maine in 2011 and 2012 and the mild winter of 2011-2012 may have contributed to the apparent increase in occurrence in our state. When animal populations reach high levels, viral diseases spread more frequently.

If you shoot or see a wild turkey with these lesions, please contact the IFW office closest to you:

Ashland - (207) 435-3231
Bangor - (207) 941-4440
Enfield - (207) 732-4132
Gray - (207) 657-2345
Greenville - (207) 695-3756
Jonesboro - (207) 434-5927
Sidney - (207) 547-5300
Strong - (207) 778-3324

MAINE DEPARTMENT OF INLAND FISHERIES AND WILDLIFE

CHANDLER E. WOODCOCK, COMMISSIONER
ANDREA L. ERSKINE, DEPUTY COMMISSIONER

Members of the Commissioner's Advisory Council

Cathy A. DeMerchant, Androscoggin, Kennebec, Sagadahoc Counties; telephone: 923-3287

Richard "Dick" Fortier, Aroostook County; telephone: 496-1221

Richard Thurston, Cumberland County; telephone: 885-5441

Sheridan R. Oldham, Franklin, Oxford Counties; telephone: 864-4323

Jeffrey C. Lewis (Chair), Hancock County; telephone: 667-6859

Gunnar Gundersen, Knox, Lincoln, Waldo Counties; telephone: 563-1959

Donald F. Dudley, Penobscot County; telephone: 538-5173

Lila S. Ware, Piscataquis, Somerset Counties; telephone: 474-5430

Lance S. Wheaton (Vice-Chair), Washington County; telephone: 448-7726

Robert S. Savage, York County; telephone: 637-2261

Main Office: #41 State House Station, Augusta, Maine 04333-0041

For Administration, Fisheries and Wildlife, Warden Service,
general information about fish and wildlife, licenses, and
boating and recreational vehicle registration... call (207) 287-8000.

Check out our home page on the Internet at <http://www.maine.gov/ifw>.

Regional Headquarters (Game Wardens and Biologists)

Ashland -- 435-3231

Bangor -- 941-4440

Gray -- 657-2345

Greenville -- 695-3756

Sidney -- 547-5300

Additional Regional Offices (Biologists)

Enfield -- 732-4132

Jonesboro -- 434-5927

Strong -- 778-3324

Research and Assessment Section, Species Specialist Office

Bangor -- 941-4466

If you cannot locate a Warden at the above numbers,
contact the nearest State Police barracks:

State Police Toll-free Numbers

Augusta 1-800-452-4664 / Houlton 1-800-924-2261

Orono 1-800-432-7381 / Gray 1-800-228-0857

Cellular Calls - 911

CONSERVATION PLATES DO GREAT THINGS



Support Maine's State Parks and Endangered Wildlife!
Register your car or truck with Conservation License Plates.

Do a great thing for Maine today!

There's something wild lurking on
your tax return!



Give a gift to
wildlife this year -
put a check with
the chickadee!



Conservation License Plate funds are administered by the
Department of Conservation and the
Department of Inland Fisheries and Wildlife

