

Attachment IX

November 20, 2017

CENTRAL MAINE POWER

±320 kV HVDC UG Transmission Line and Termination Stations Kennebec River Crossing *HVDC Underground Transmission Line Crossing Report*

PROJECT NUMBER:
147483

PROJECT CONTACT:

Jesse Sawin
Les Hinzman
Mark Reynolds

EMAIL:

jesse.sawin@powereng.com
les.hinzman@powereng.com
mark.reynolds@powereng.com

PHONE:

(207) 869-1443
(208) 788-0577
(503) 892-6733



HVDC Underground Transmission Line Crossing Report

PREPARED FOR: CENTRAL MAINE POWER

PREPARED BY:

JESSE SAWIN

(207) 869-1443

JESSE.SAWIN@POWERENG.COM

LES HINZMAN

(208) 788-0577

LES.HINZMAN@POWERENG.COM

MARK REYNOLDS

(503) 892-6733

MARK.REYNOLDS@POWERENG.COM

REVISION HISTORY		
DATE	REVISED BY	REVISION
10/20/17	Les Hinzman	A – Issued for Review
11/01/17	Les Hinzman	B – Draft Report
11/17/17	Les Hinzman	0 – Final Report
11/20/17	Les Hinzman	1 – Final Report

TABLE OF CONTENTS

INTRODUCTION..... 1

 TERMINATION STATION(S) SUMMARY DESCRIPTION 3

 CABLE AMPACITY 5

 RELIABILITY ASSESSMENT 5

 ESTIMATED COSTS ±320 kV HVDC OVERHEAD AND UNDERGROUND TRANSMISSION LINES 5

APPENDICES

- ESTIMATE BACKUP
- UG CABLE AMPACITY
- STATION LAYOUT AND ROUTE MAPS
- RELIABILITY ANALYSIS
- DESIGN CRITERIA

INTRODUCTION

The Central Maine Power (CMP) High Voltage Direct Current (HVDC) Transmission Line for the New England Clean Energy Connect (NECEC) Project is a ± 320 kV HVDC overhead, single circuit or symmetrical monopole (2-line poles) transmission line capable of transferring 1,200 MW. The project is about 207 miles overall with approximately 145 miles within the US. The line extends through Western Maine from the Appalaches Substation in Thetford Mines, Quebec, Canada and terminates near Lewiston, Maine in the United States. CMP is considering a ± 320 -kV HVDC underground transmission line for the crossing of the Kennebec River.

The ± 320 -kV HVDC underground transmission line segment would be installed in lieu of an overhead river crossing span. The project would require two overhead-to-underground Cable Termination (Transition) Stations located near the Kennebec River. In order to achieve the 1,200 Megawatt (MW) rating, each pole will require a 2500 mm² (nearly equivalent to 5,000 kcmil) copper conductor, cross-linked polyethylene (XLPE) insulated underground cable. A spare cable would be installed that could be connected to either pole after only a brief outage should a cable or termination failure occur.

A Horizontal Directional Drill (HDD), approximately 2,900 feet in length and 360 feet in depth, would be utilized for the Kennebec River crossing to install a duct bank consisting of, at a minimum: three (3) ten-inch (10") ducts, one (1) four-inch (4") duct, and two (2) two-inch (2") ducts (all HDPE).



NECEC ± 320 -kV HVDC Underground Transmission Line - Kennebec River Crossing

It is anticipated that the HDD could be accomplished with a thirty-six inch (36") bore annulus within the proposed overhead transmission line corridor, which is 300 feet in width. The bore would pass beneath the Kennebec River with approximately thirty-feet (30') of clearance from the river bottom.

The HVDC underground cable installation would require approximately fifteen-hundred feet (1500') of open trenching to connect to the Cable Termination Stations.

Pull-through vaults will be located within each station. These vaults would be utilized for splicing should a termination failure occur allowing for the replacement of a short length of cable for the termination restoration.



Proposed Access Roads

Upgrades on approximately fifteen miles of unimproved roads and the associated bridges would be required to provide access to the Termination Substations in addition to the grading necessary for the stations and the laydown area for the drilling equipment. The costs for the access roads are included in both the Overhead Line estimate and the Termination Substation estimate, but not in the underground estimate.



Eastern Access: One-Lane Bridge near East Moxie

Eastern Access: Utilize US Highway 201, Lake Moxie Road, and Indian Pond Road to Black Brook Pond Road. Continue on Brook Pond Road to Fish Road and Fish Pond Road where the access will then extend over local logging roads, although some tree clearing and new roadway may be necessary. Also, bridge weight limits along this route would be questionable and could require upgrades, which were not considered in these estimated costs.

Western Access: From US Highway 201 use Capital Road and Wilson Hill Road to the area near the transition station where the access may require some tree clearing and new roadway.

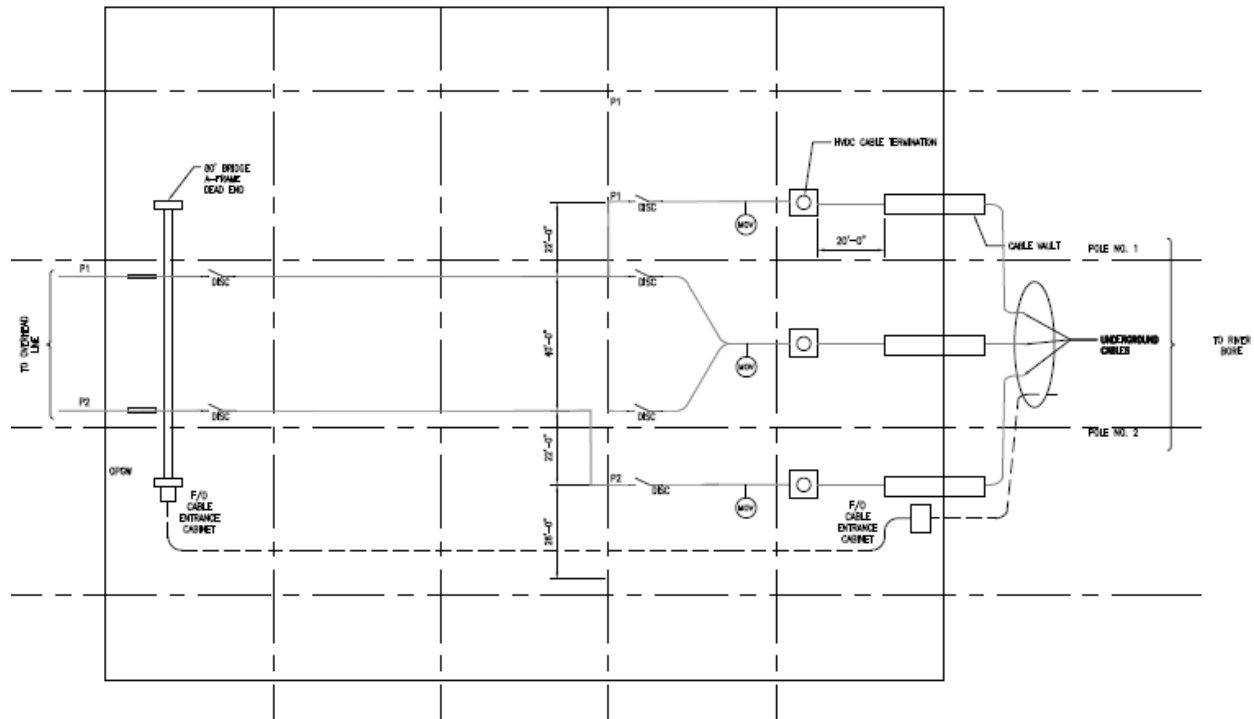

Termination Station Layout

Termination Station(s) Summary Description

The project will include two Kennebec River Termination Stations to transition the underground cable section of ±320 kV HVDC transmission system. There would be three underground XLPE Type (Oil Free) Cables installed as well as a section fiber optic cable to transition from overhead optical ground wire (OPGW) to underground type or loose-tube cable. The station development is essentially the same on both sides of the river, with an approximate 200 foot by 250 foot station footprint.

Except for the Overhead Line (OH) deadend the development the overall station would be a low profile arrangement, which will not be visible from the river in the current proposed locations. The termination stations would require some light vehicular access after construction is complete, and would normally have only infrequent operations staff visits to check security and equipment serviceability. There would not be any permanent power (station service) development or building developments at the stations.

Cable Ampacity

A study was performed to identify a preliminary cable conductor size to meet the requirements for normal loadings of the ±320-kV HVDC underground transmission line crossing of the Kennebec River.

Calculations were performed using CYME International’s Cable Ampacity Program (CYMCAP) version 7.2 Rev. 3 in accordance with IEC 60287 “Electric Cables – Calculation of the Current Rating”. The assumptions for this calculation are based on the design criteria for the project utilizing engineering design experience:

Nominal Voltage:..... ±320 kV HVDC
 Conductor: 2500 mm² Circular Copper
 Cable System: Cross Length Polyethylene (XLPE)
 Maximum Conductor Operating Temperature: 70°C (steady-state)
 Assumed Native Soil Thermal Resistivity: 80°C-cm/W
 Assumed Thermal Backfill Thermal Resistivity: 60°C-cm/W
 Assumed Drilling Fluid Thermal Resistivity: 140°C-cm/W
 Daily (24-Hour) Load Cycle Factor: 100%
 Assumed Earth Ambient Temperature: 6°C (42°F)
 Cable Conduit: 10-inch HDPE SDR 9
 Target Ampacity: 1,875 Amps (1,200 MVA)

Maximum cable ampacity was calculated for the following case:
 Horizontal directional drill 36-inch bore crossing thirty feet (30’) beneath the Kennebec River bottom rated for 1,877 Amps. This can be accomplished with a 2,500 mm² copper conductor XLPE cable. It should be noted that this cable would limit the overload capability of the HVDC equipment.

Reliability Assessment

Availability ratings for a ±320 kV HVDC overhead and underground transmission lines are similar, however, it should be noted that HVDC cable faults are usually if not always non-restorable without removal and replacement of at least one of the pole conductors, which is why the installed spare cable is being considered.

Estimated Costs ±320 kV HVDC Overhead and Underground Transmission Lines

The purpose of these estimates is to create a budgetary comparison of the overhead vs. underground alternatives. Several costs would be the same for both alternatives such as: real estate, owner internal costs, program management, AFUDC, etc. and are not included to simplify the comparison of the two alternatives.

DESCRIPTION	COSTS (2017)	COSTS (2021)
UG T-Line	\$19,602,100	\$21,217,943
Transition Station (East)	\$ 7,226,000	\$ 7,821,655
Transition Station (West)	\$ 7,486,000	\$ 8,103,087
Total	\$34,314,100	\$37,142,685

DESCRIPTION	COSTS (2017)	COSTS (2021)
Overhead T-Line Crossing (3 Structures)	\$ 5,613,717	\$ 6,076,287

CONFIDENTIAL

IECG-001-033
Attachment 1, Page 9 of 70
Docket No. 2017-232

APPENDICES

CONFIDENTIAL

Kennebec Gorge Crossing OH Costs - Option 1			
Overhead Line Summary	Material Costs	Labor Costs	Total Cost
(2) Self-Supporting DE Structures	\$250,221	\$910,180	\$1,160,401
(1) Tangent Structures	\$40,643	\$0	\$40,643
Conductor, OPGW, & OHGW	\$37,821	\$56,010	\$93,831
Insulators	\$34,580	\$0	\$34,580
Hardware	\$903	\$0	\$903
Access, Inspection, Environmental Controls, Clearing, & Mob/Demob	\$0	\$3,026,600	\$3,026,600
Survey	\$0	\$100,000	\$100,000
Permitting, Engineering, & Procurement	\$0	\$201,110	\$201,110
Sales Tax	\$20,029.26	\$0	\$20,029.26
Subtotal			\$4,678,097
20% Contingency			\$935,619
Total (2017)			\$5,613,717
Total (2021)			\$6,076,287

General Assumptions

- Crossing Length – 2,560'
- Tangent Structures – Direct Embed Steel Poles
- Dead End Structures – Self Supporting Steel Poles on Drilled Shaft Foundations
- 1590 kcmil 54/19 ACSR “Falcon” Conductor – Twin Bundled Poles
- OPGW – 0.913” Diameter
- OHGW – 7 No.7 Alumoweld
- 1 Tangent
- 2 Dead Ends

CONFIDENTIAL**Preliminary**

**Iberdrola - CMP
Kennebec River Crossing: +/- 320kV, 1200 MVA HVDC
Summary of Costs**

UNDERGROUND LINE SUMMARY	XLPE Cable System Costs		Total Cost
	Material Costs	Labor Costs	
Duct Bank	\$292,400	\$496,200	\$788,600
Trenchless Installations	\$4,785,000	\$4,785,000	\$9,570,000
Manholes	\$360,000	\$300,000	\$660,000
Cable	\$1,825,000	\$187,500	\$2,012,500
Splices	\$33,000	\$0	\$33,000
Arresters	\$17,600	\$15,000	\$32,600
Additional Cable Accessories	\$61,100	\$55,500	\$116,600
Communication System	\$16,800	\$23,800	\$40,600
Temperature Monitoring System	\$113,200	\$51,800	\$165,000
Transition Structures, ea	\$138,000	\$72,000	\$210,000
Mob/Demob	\$0	\$450,000	\$450,000
Survey	\$0	\$100,000	\$100,000
Partial Discharge Testing	\$0	\$200,000	\$200,000
Engineering and Construction Management	\$0	\$1,200,000	\$1,200,000
Sales Tax (5.5%)	\$434,100	\$0	\$434,100
SUBTOTAL	\$7,892,100	\$8,008,800	\$16,335,000
20% Contingency	\$1,665,300	\$1,601,800	\$3,267,100
TOTAL (2017)	\$9,557,400	\$9,410,600	\$19,602,100
TOTAL (2021)			\$21,217,943

Underground Transmission Line Notes:

1. +/-320kV, 1200 MVA, HVDC, 1 cable per pole, 1 installed spare cable 2500 mm² Cu, XLPE insulation
2. One (1) 2900 ft length, 36 inch dia HDD bores without casings
3. 1500 ft total open trench lengths adding both sides
4. Fluidized thermal backfill for 100% of the open trench portion of the route
5. Six (6) arresters with two (2) spares included
6. Six (6) Terminations with two (2) spares included
7. One (1) communication circuit, 48 count loose tube fiber optic cable, with testing
8. Temperature monitoring equipment included for remote operation
9. Costs associated with excavation of rock included
10. No reel of spare cable included
11. No reactive compensation included
12. State sales tax included at 5.5%
13. Transition structures, foundations, and access roads included in Transition Station estimate
14. Materials used in this cost estimate meet all applicable industry standards
15. Costs for: access roads, vegetation and tree clearing included in Transition Station estimate
16. Dewatering assumed unnessessary
17. Escalation calculated at 2% per year

CMP 1-Cable Per Pole



Kennebec River Crossing (Eastern Terminal) HVDC

PLANNING ESTIMATE

DESCRIPTION	LABOR	MATERIAL	L & M
ESTIMATED COST SUMMARY			
EQUIPMENT (outdoor)	264,000	567,000	831,000
STRUCTURES	321,000	698,000	1,019,000
FOUNDATIONS	278,000	108,000	386,000
CABLE & CONDUIT	88,000	55,000	143,000
CONTROL ENCLOSURE	-	-	-
SITE IMPROVEMENTS	2,302,000	547,000	2,849,000
REMOVALS	-	-	-
TESTING & ENERGIZATION	95,000	-	95,000
SUBTOTAL	3,348,000	1,975,000	5,323,000
CONTRACTOR MOB/DEMOB			-
CONSTRUCTION MANAGEMENT			216,000
ENGINEERING			373,000
ENVIRONMENTAL			
REAL ESTATE COSTS			
UTILITY INTERNAL COSTS (0%)			-
SALES TAX (5.5%)			109,000
SUBTOTAL			6,021,000
CONTINGENCY (20%)			1,205,000
TOTAL ESTIMATED COST			7,226,000
TOTAL ESCALATED COST	2021	2% per year	7,821,655

1 Cable Per Pole



Kennebec River Crossing (Western Terminal) HVDC

PLANNING ESTIMATE

DESCRIPTION	LABOR	MATERIAL	L & M
ESTIMATED COST SUMMARY			
EQUIPMENT (outdoor)	313,000	633,000	946,000
STRUCTURES	291,000	646,000	937,000
FOUNDATIONS	390,000	151,000	541,000
CABLE & CONDUIT	88,000	55,000	143,000
CONTROL ENCLOSURE	-	-	-
SITE IMPROVEMENTS	2,302,000	547,000	2,849,000
REMOVALS	-	-	-
TESTING & ENERGIZATION	95,000	-	95,000
SUBTOTAL	3,479,000	2,032,000	5,511,000
CONTRACTOR MOB/DEMOB			-
CONSTRUCTION MANAGEMENT			229,000
ENGINEERING			386,000
ENVIRONMENTAL			
REAL ESTATE COSTS			
UTILITY INTERNAL COSTS (0%)			-
SALES TAX (5.5%)			112,000
SUBTOTAL			6,238,000
CONTINGENCY (20%)			1,248,000
TOTAL ESTIMATED COST	2017		7,486,000
TOTAL ESCALATED COST	2021	2% per year	8,103,087

Client: Central Maine Power
Project Name: Kennebec River Crossing
Project Number: 147483

Prepared By: Ethan Evans
Date: 15-Nov-17
Checked By: Les Hinzman
Date: 15-Nov-17

HDD Bore Design - Ampacity Calculation Summary

Case	Case Description	Steady State Ampacity Requirement (A)	Max Operating Temperature of Conductor (°C)	Results					Installation Assumptions				
				Max Continuous Ampacity (A)	Load Factor (%)	Earth Ambient Temperature (°F)	Bentonite Drilling Fluid Thermal Resistivity (°C-cm/W)	Native Soil Thermal Resistivity (°C-cm/W)					
1	36 inch HDD Bore, 30 ft from top of Borehole to Bottom of Kennebec River							42	140	80			
	± 320 kV HVDC	1875	70	1881	100								

Calculations modeled using CYMCAP 7.2 Rev. 3

Cable

- Conductor size: 2500 mm² circular Cu
- Insulation thickness: 846 mils
- Shield type: Aluminum laminate

Assumptions

- 36 inch HDD bore without casing, with 10" SDR 9 HDPE Conduit
- Steady state ampacity requirement DC line - 1875A (1200 MVA)
- No bonding in DC installations
- Drilling fluid (bentonite) backfill used in bore
- Skin, Proximity Effects, and Dielectric Losses not a factor in DC installations

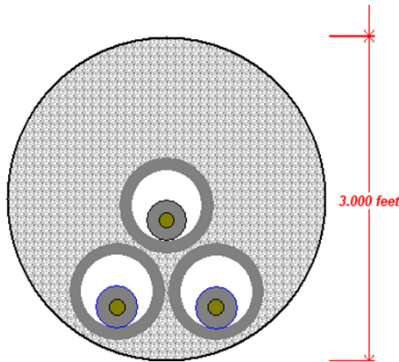

HDD BORE DETAIL

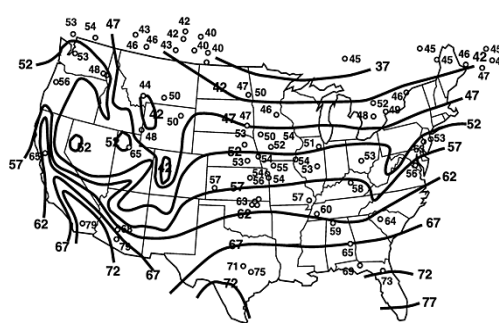

Mean annual earth temperature observations at individual stations, superimposed on well-water temperature contours.

MEAN ANNUAL TEMPERATURE

CABLE DRAWING 2500 mm² Cu XLPE 320kV (HVDC)



1 – CONDUCTOR	Segmented or circular Cross-section: 2500 mm ² Material: Copper Indicative diameter: 62.3 mm (2.45 inch)
2 - INNER SEMI-CONDUCTIVE LAYER	Indicative thickness: 1.5 mm (59 mils)
3 - INSULATION	Material: cross-linked polyethylene Minimum average thickness*: 21.5 mm (846 mils)
4 - OUTER SEMI-CONDUCTIVE LAYER	Indicative thickness: 1.5 mm (59 mils)
5 - SWELLING TAPES	
6 - ALUMINUM LAMINATE	Indicative thickness: 0.5 mm (20 mils)
7 - OUTER SHEATH AND EXTRUDED SEMICONDUCTING LAYER	Material: HDPE Minimum average thickness*: 4 mm (157 mils)
	INDICATIVE EXTERNAL DIAMETER (D): 125 MM (4.9 IN)
	INDICATIVE WEIGHT: 31.6 KG/M (21.2 LBS/FT)
	MINIMUM BENDING RADIUS** - during pulling: 35 D in ducts, 30 D on rollers. - in permanent: 20 D
	MAXIMUM PULLING TENSION**: 22500 lbs (10000 daN)
	MAXIMUM SIDEWALL PRESSURE: 2000 lbs/ft (3000 daN/m)

* The measured thickness at any point may be smaller within the tolerances defined in the IEC 62067

** Real values to be applied during installation will be validated by General Cable based on real installation data, pulling tension, sidewall pressure, once the site survey will be performed on the final cable route. Installation conditions when cables are pulled on rollers shall avoid any excessive side wall pressures and guarantee safe working conditions.

ELECTRICAL CHARACTERISTICS

Nominal DC resistance at 20°C:	0.072 Ω/km (0.0219 Ω/1000ft)
Nominal DC resistance at 70°C	0.087 Ω/km (0.0265 Ω/1000ft)
Nominal capacitance:	0.256 μF/km (0.078 μF/1000ft)
Maximum conductor temperature	70°C

CONFIDENTIAL

Study Summary

CYMCAP Version	7.2 Revision 01
Study:	320 kV DC and 1200 MW Cable Sizing Calculations Max LF
Execution:	2500mm2 320 kV DC 1 cb_ph W_Spare 15 deg Tr MaxLF
Date:	11/15/2017 1:13:18 PM

General Simulation Data

Steady State Option	Unequally Loaded
Consider Electrical interaction between circuits	No
Induced currents in metallic layers as a fraction of conductor current (applied to all single phase circuits) :	0.0
Conductor Resistances Computation Option:	IEC-228

Installation Type: Multiple Ductbanks/Backfills

Ambient Soil Temperature at Installation Depth	[°C]	6.0
Native Soil Thermal Resistivity	[K.m/W]	0.8
Consider Non-Isothermal Earth Surface		No

Layer Name	X [ft]	Y [ft]	Width [ft]	Height [ft]	Thermal Resistivity [K.m/W]
NSTD DB1	0.0	34.5	2.729	2.729	1.4

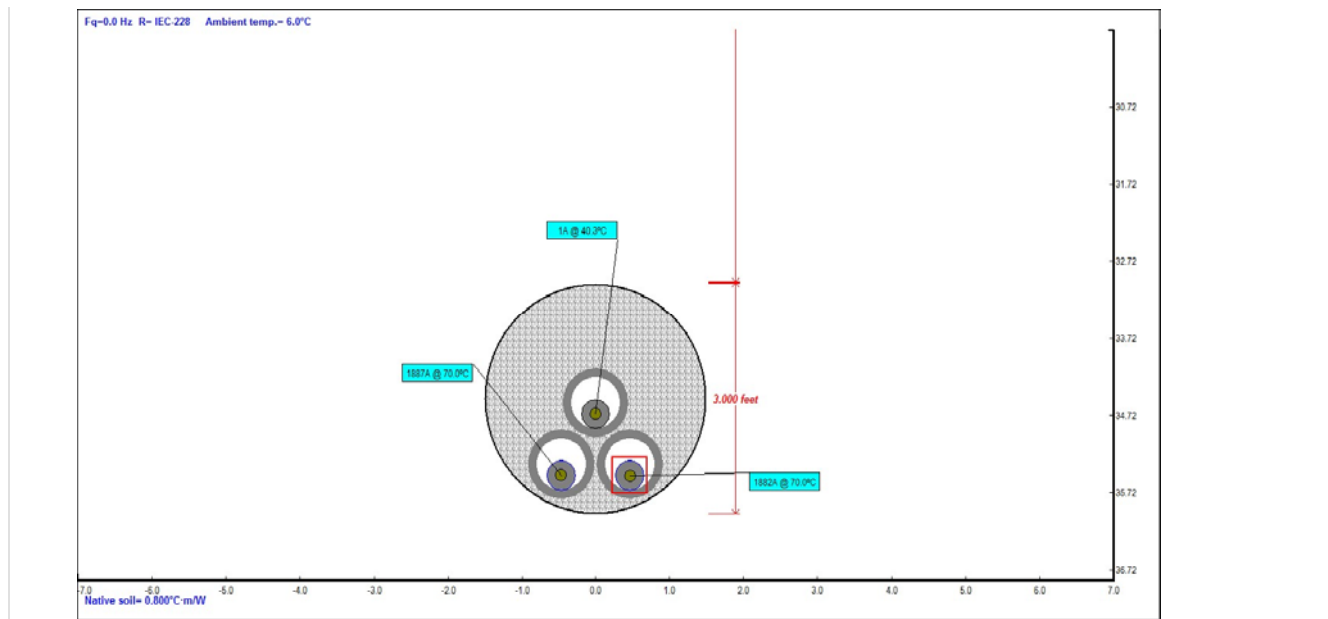

Results Summary

Cable No.	Cable ID	Circuit No.	Feeder ID	Cable Phase	Cable Frequency	Daily Load Factor	X coordinate [ft]	Y coordinate [ft]	Conductor temperature [°C]	Ampacity [A]
1	GEN CABLE 2500MM HVDC	1		A	0.0	1.0	0.47	35.5	70.0	1881.6
2	GEN CABLE 2500MM HVDC	2		A	0.0	1.0	-0.47	35.5	70.0	1887.3
3	GEN CABLE 2500MM HVDC	3		A	0.0	1.0	0.0	34.7	40.3	1.0

CONFIDENTIAL

	Cables Report
CYMCAP Version	7.2 Revision 01
Study:	320 kV DC and 1200 MW Cable Sizing Calculations Max LF
Execution:	2500mm ² 320 kV DC 1 cbl_ph W_Spare 15 deg Tr MaxLF
Date:	11/15/2017 1:13:18 PM

No.	Description	Unit	1
General Cable Information			
1	Cable Equipment ID		GEN CABLE 2500MM HVDC
2	Number of Cores		Single Core
3	Voltage	[kV]	640
4	Conductor Area	[in ²]	3.88
5	Cable Overall Diameter	[in]	4.73
6	Maximum Steady-State Conductor Temperature	[°C]	70
7	Maximum Emergency Conductor Temperature	[°C]	110
Conductor			
8	Material		Copper
9	Electrical Resistivity at 20°C	[μΩ.cm]	1.7241
10	Temperature Coefficient at 20°C	[1/K]	0.00393
11	Reciprocal of Temperature Coefficient of Resistance (BETA)	[K]	234.5
12	Volumetric Specific Heat (SH)	[J/(K*cm ³)]	3.45
13	Construction		Round Stranded
14	Number of Wires Composing Stranded Conductor		n/a
15	Conductor Insulation System		Extruded
16	Milliken Wires Construction		n/a
17	Ks (Skin Effect Coefficient)		1
18	Kp (Proximity Effect Coefficient)		1
19	Diameter	[in]	2.45
Conductor Shield			
20	Thickness	[in]	0.06
21	Diameter	[in]	2.57
Insulation			
22	Material		XLPE Unfilled
23	Thermal Resistivity	[K.m/W]	3.5
24	Dielectric Loss Factor - (tan delta)		0.001
25	Relative Permittivity - (epsilon)		2.5
26	Specific Insulation Resistance Constant at 60°F - (K)	[MΩ.1000ft]	20000.
27	Thickness	[in]	0.85
28	Diameter	[in]	4.26
Insulation Screen			
29	Material		Semi Conducting Screen
30	Thickness	[in]	0.06
31	Diameter	[in]	4.38

CONFIDENTIAL

Sheath			
32	Is Sheath Around Each Core?		n/a
33	Material		Aluminum
34	Electrical Resistivity at 20°C	[μΩ.cm]	2.8264
35	Temperature Coefficient at 20°C	[1/K]	0.00403
36	Reciprocal of Temperature Coefficient of Resistance (BETA)	[K]	228
37	Volumetric Specific Heat (SH)	[J/(K*cm³)]	2.5
38	Corrugation Type		Non Corrugated
39	Thickness	[in]	0.02
40	Diameter	[in]	4.42
Jacket			
41	Material		Polyethylene
42	Thermal Resistivity	[K.m/W]	3.5
43	Thickness	[in]	0.16
44	Diameter	[in]	4.73

No.	Description	Unit	1
Specific Installation Data			
45	Cable Equipment ID		GEN CABLE 2500MM HVDC
46	Cable Frequency	[Hz]	0.0001
47	Sheath / Shield Bonding		1 Conductor No Bonding
48	Loss Factor Constant (ALOS)		0.3
49	Duct construction		Polyethylene in Concrete
50	Duct material thermal resistivity	[K.m/W]	3.5
51	Inside Diameter of the Duct/Pipe	[in]	8.22
52	Outside Diameter of the Duct/Pipe	[in]	10.75

CONFIDENTIAL**Cable ID : GEN CABLE 2500MM HVDC**

Cable Title General Cable 2500 mm2 Cu XLPE 320kV HVDC

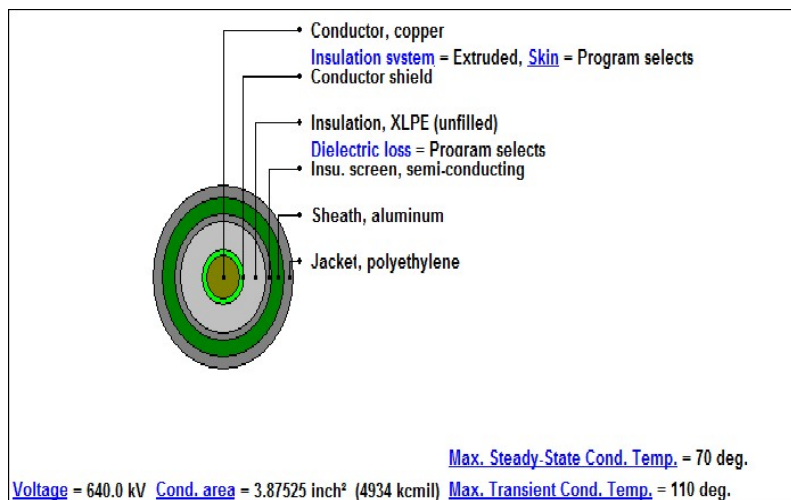
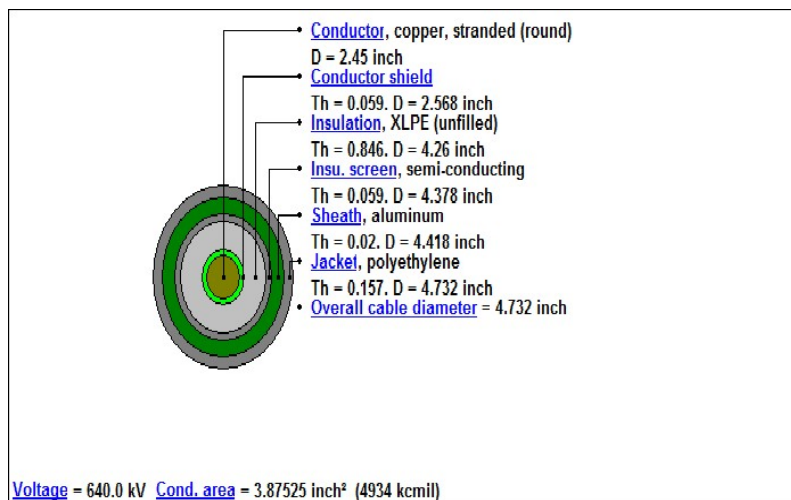

CONFIDENTIAL

EYME INTERNATIONAL T&D		Electrical Parameters
CYMCAP Version	7.2 Revision 01	
Study:	320 kV DC and 1200 MW Cable Sizing Calculations Max LF	
Execution:	2500mm ² 320 kV DC 1 cbl_ph W_Spare 15 deg Tr MaxLF	
Date:	11/15/2017 1:13:18 PM	

No.	Description	Unit	Cable No.1	Cable No.2	Cable No.3
1	Cable Equipment ID		GEN CABLE 2500MM HVDC	GEN CABLE 2500MM HVDC	GEN CABLE 2500MM HVDC
Resistances					
2	DC Resistance of the conductor at 20°C	[Ω/mile]	0.01132	0.01132	0.01132
3	DC Resistance of Conductor at Operating Temperature	[Ω/mile]	0.01354	0.01354	0.01222
4	AC Resistance of Conductor at 20°C	[Ω/mile]	0.01132	0.01132	0.01132
5	AC Resistance of Conductor at Operating Temperature	[Ω/mile]	0.01354	0.01354	0.01222
6	DC Resistance of Sheath at 20°C	[Ω/mile]	0.25514	0.25514	0.25514
7	DC Resistance of Sheath at Operating Temperature	[Ω/mile]	0.29665	0.29659	0.276
Losses					
8	Conductor Losses	[W/ft]	9.08223	9.13685	0.0
9	Dielectric Losses	[W/ft]	0.00001	0.00001	0.00001
10	Metallic Screen Losses	[W/ft]	0.0	0.0	0.0
11	Aarmor/Pipe Losses	[W/ft]	0.0	0.0	0.0
12	Total Losses	[W/ft]	9.08224	9.13685	0.00001
Capacitance, Inductance, Impedance					
13	Capacitance	[μF/mile]	0.44096	0.44096	0.44096
14	Inductance of Conductor	[mH/mile]	0.0	0.0	0.0
15	Reactance of Conductor	[Ω/mile]	0.0	0.0	0.0
16	Inductance of Metallic Sheath	[mH/mile]	0.0	0.0	0.0
17	Reactance of Metallic Sheath	[Ω/mile]	0.0	0.0	0.0
18	Positive Sequence Impedance	[Ω/mile]	0.013551 + j0.000000	0.013551 + j0.000000	0.012215 + j0.000000
19	Negative Sequence Impedance	[Ω/mile]	0.013551 + j0.000000	0.013551 + j0.000000	0.012215 + j0.000000
20	Zero Sequence Impedance	[Ω/mile]	0.266459 + j0.000000	0.266459 + j0.000000	0.266459 + j0.000000
21	Surge Impedance	[Ω]	0.00001	0.00001	0.00001
Others					
22	Dielectric Stress at Conductor Surface	[kV/in]	568.56764	568.56764	568.56764
23	Dielectric Stress at Insulation Surface	[kV/in]	342.74218	342.74218	342.74218
24	Insulation Resistance at 60°F (15.8°C)	[MΩ.1000ft]	4396.29159	4396.29159	4396.29159
25	Reduction Factor		0.0	0.0	0.0
26	Charging Current for One Phase	[A/mile]	0.0001	0.0001	0.0001
27	Charging Capacity of three phase system at Uo	[kvar/mile]	0.11365	0.11365	0.11365
28	Voltage drop for Three Phase System	[V/A/mile]	0.02346	0.02346	0.02117
29	Induced Voltage (standing) on Sheath	[V/mile]	n/a	n/a	n/a
30	Induced current on Metallic Screen	[A]	0.0	0.0	0.0

CONFIDENTIAL**Mears Group, Inc.**

A QUANTA SERVICES COMPANY

±320 kV HVDC UG Transmission Line - Kennebec River Crossing

A planned Horizontal Directional Drill (HDD), approximately 2,900 feet in length and 360 feet in depth, would be utilized for the crossing of the Kennebec River with a high voltage underground transmission line to install a duct bank consisting of three (3) ten-inch (10") ducts, one (1) four-inch (4") duct, and two (2) two-inch (2") ducts (all HDPE).

It is anticipated that the HDD could be accomplished within the proposed overhead transmission line corridor, which is 300 feet in width, with a thirty-six inch (36") bore annulus. The bore would pass beneath the Kennebec River with around thirty-feet (30') of clearance from the river bottom.

Mears Group, Inc. - Horizontal Directional Drilling/Direct Pipe®

5051 Westheimer Road, Suite 1650 - Houston, TX 77056 - 281.448.2488 – www.mearsHDD.net

Certified in Safety, Quality & Environment: OHSAS 18001:2007, ISO 9001:2015 and ISO 14001:2004

CONFIDENTIAL

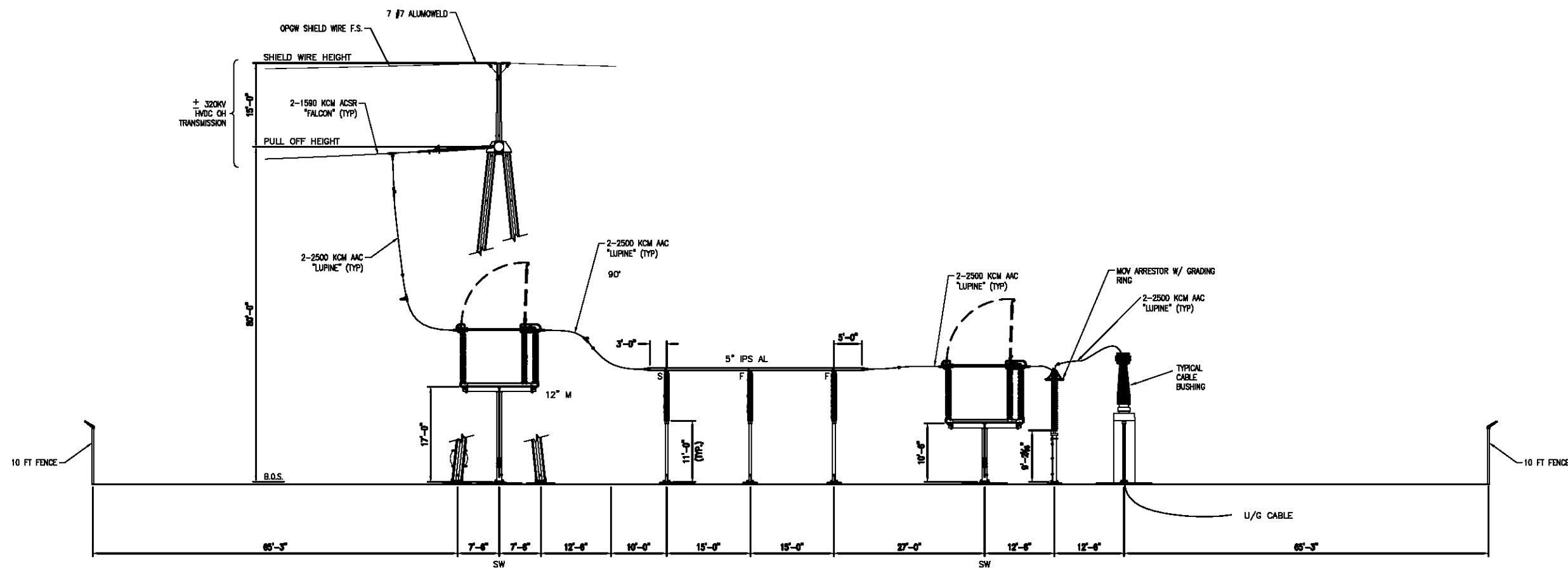

ELEVATION A-A

NOTE
 1. SPARE Hyd. CABLE TO BE ENERGIZED FROM EITHER POLE FOR LONG TERM CABLE CARE

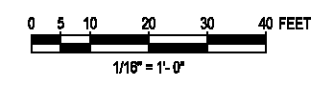

**PRELIMINARY
 NOT FOR
 CONSTRUCTION**

CMP-CON-ELEV.DWG

THIS DRAWING WAS PREPARED BY POWER ENGINEERS, INC. FOR A SPECIFIC PROJECT, TAKING INTO CONSIDERATION THE SPECIFIC AND UNIQUE REQUIREMENTS OF THE PROJECT. REUSE OF THIS DRAWING OR ANY INFORMATION CONTAINED IN THIS DRAWING FOR ANY PURPOSE IS PROHIBITED UNLESS WRITTEN PERMISSION FROM BOTH POWER AND POWER'S CLIENT IS OBTAINED.

REV	REVISIONS	DATE	DRN	DSGN	CKD	APPD	REFERENCE DRAWINGS

DSGN	PEI	*
DRN	*	*
CKD	*	*
SCALE:		3/32"=1'-0"
FOR 22&4 DWG ONLY		



CENTRAL MAINE POWER	JOB NUMBER	REV
NEW ENGLAND CLEAN ENERGY CONNECT PROPOSED KENNEBEC RIVER CROSSING	144357	△
CONCEPTUAL UNDERGROUND LINE UG CABLE TERMINATION STATION TYPICAL ELEVATION	DRAWING NUMBER	CMP-CON-ELEV

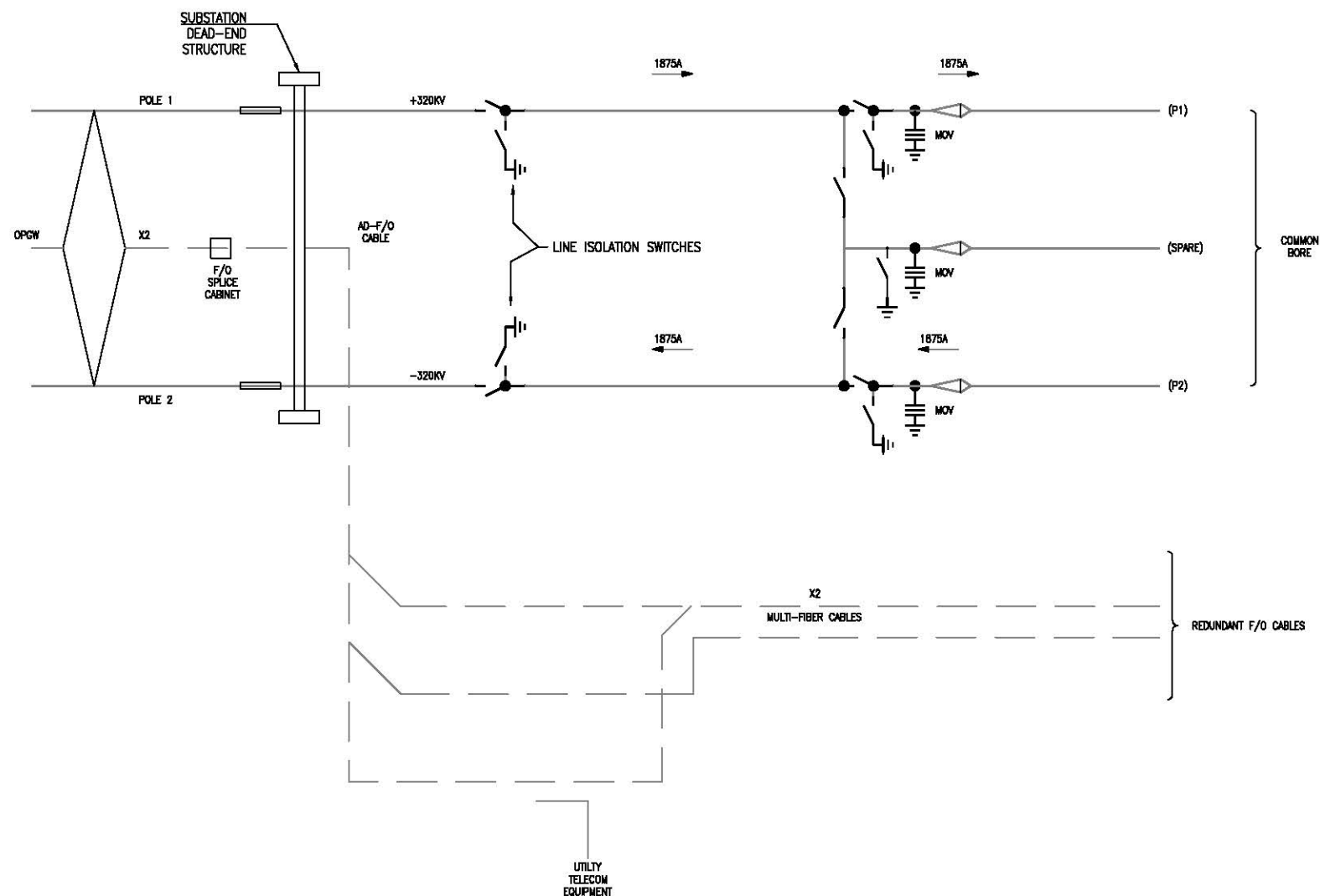

CONFIDENTIAL



NOTE

1. SPARE HVDC CABLE TO BE ENERGIZED FROM EITHER POLE FOR LONG TERM CABLE CARE.

LEGEND

-  MANUAL DISCONNECT WITH GROUND BLADE
-  MOV ARRESTOR
-  HVDC CABLE TERMINATION

**PRELIMINARY
NOT FOR
CONSTRUCTION**

CMP-ONE-LINE.DWG

THIS DRAWING WAS PREPARED BY POWER ENGINEERS, INC. FOR A SPECIFIC PROJECT. TAKING INTO CONSIDERATION THE SPECIFIC AND UNIQUE REQUIREMENTS OF THE PROJECT, REUSE OF THIS DRAWING OR ANY INFORMATION CONTAINED IN THIS DRAWING FOR ANY PURPOSE IS PROHIBITED UNLESS WRITTEN PERMISSION FROM BOTH POWER AND POWER'S CLIENT IS GRANTED.

REV	REVISIONS	DATE	DRN	DSGN	CKD	APPD	REFERENCE DRAWINGS

DSGN	PEI	*
DRN	*	*
CKD	*	*
SCALE:		NONE
FOR 28x41 DWG ONLY		



CENTRAL MAINE POWER	JOB NUMBER	REV
NEW ENGLAND CLEAN ENERGY CONNECT PROPOSED KENNEBEC RIVER CROSSING	144357	△
CONCEPTUAL UNDERGROUND LINE UG CABLE TERMINATION STATION TYPICAL SINGLE LINE	DRAWING NUMBER	CMP-ONE-LINE

CONFIDENTIAL

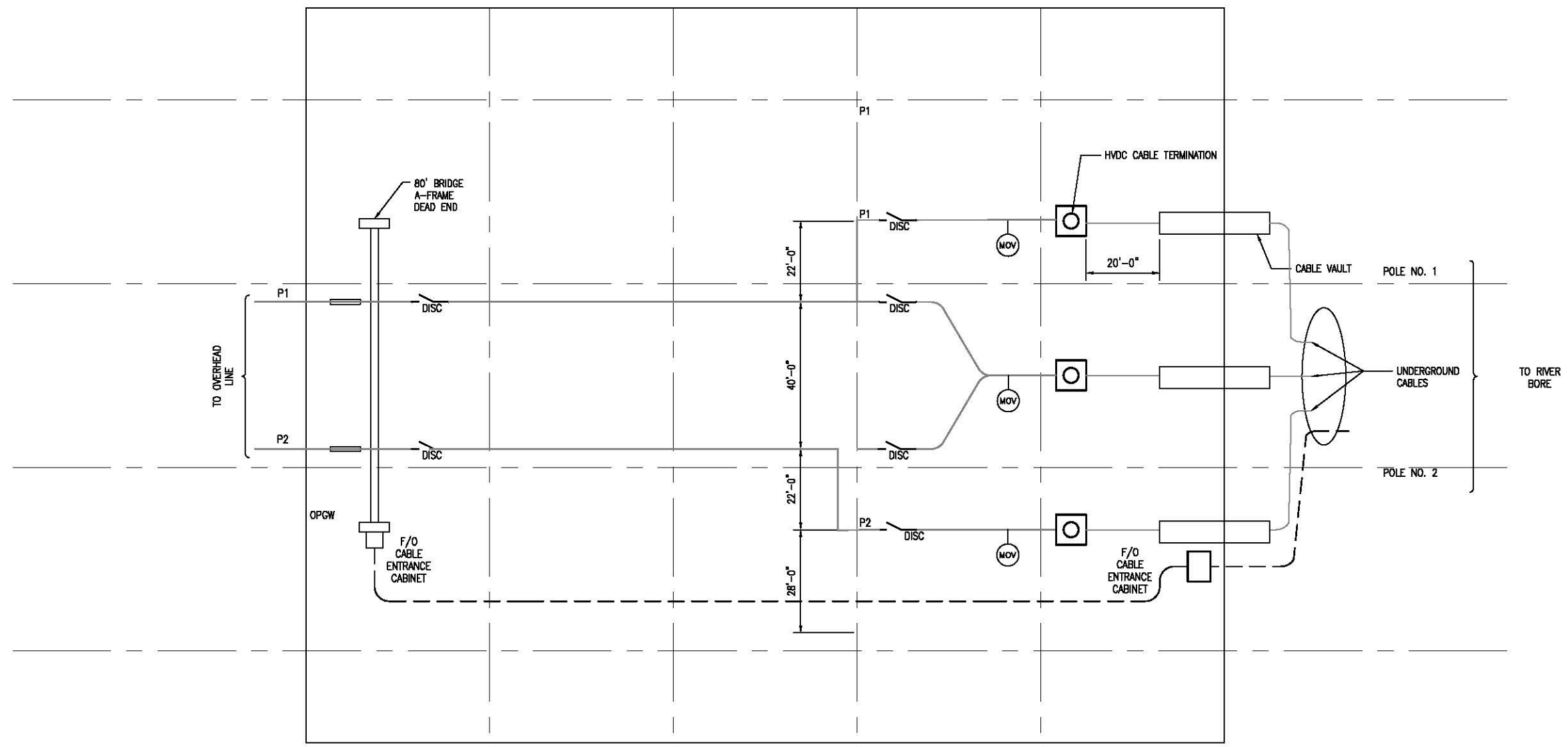

NOTE
 1. SPARE HVDC CABLE TO BE ENERGIZED FROM EITHER POLE FOR LONG TERM CABLE CARE

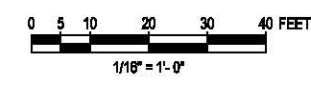

**PRELIMINARY
 NOT FOR
 CONSTRUCTION**

THIS DRAWING WAS PREPARED BY POWER ENGINEERS, INC. FOR A SPECIFIC PROJECT. TAKING INTO CONSIDERATION THE SPECIFIC AND UNIQUE REQUIREMENTS OF THE PROJECT, REUSE OF THIS DRAWING OR ANY INFORMATION CONTAINED IN THIS DRAWING FOR ANY PURPOSE IS PROHIBITED UNLESS WRITTEN PERMISSION FROM BOTH POWER AND POWER'S CLIENT IS GRANTED.

REV	REVISIONS	DATE	DRN	DSGN	CKD	APPD	REFERENCE DRAWINGS

DSGN	PEI	*
DRN	*	*
CKD	*	*
SCALE:		1/18"=1'-0"
FOR 22x34 DWG ONLY		



CENTRAL MAINE POWER	JOB NUMBER	REV
NEW ENGLAND CLEAN ENERGY CONNECT PROPOSED KENNEBEC RIVER CROSSING	144357	△
CONCEPTUAL UNDERGROUND LINE UG CABLE TERMINATION STATION TYPICAL LAYOUT	DRAWING NUMBER	CMP-UG-GL

CONFIDENTIAL

TOWN OF
WEST FORKS PLT

TOWN OF
MOXIE GORE

KENNEBEC RIVER

PROPOSED ±320 KV HVDC OVERHEAD TRANSMISSION LINE

NO.	REVISION	DATE	BY	CK	P.E.

THIS DRAWING SHALL
BE REVISED ON THE
CAD SYSTEM ONLY

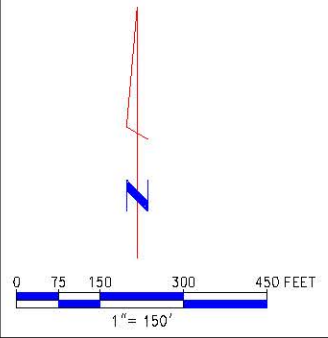

**PRELIMINARY
NOT FOR CONSTRUCTION**

LEGEND

	PROPOSED STRUCTURE LOCATION
	PROPOSED OH TRANSMISSION
	EXISTING ROW
	TOWN LINE
	PROPERTY LINE
	EDGE OF KENNEBEC RIVER

This document and any attachments are considered:
**BUSINESS CONFIDENTIAL
PROTECTED CRITICAL INFRASTRUCTURE INFORMATION**

REFERENCE DRAWINGS

NO.	REVISION	DATE	BY	CK	P.E. STAMPED BY	P.E. No.

NO.	REVISION	DATE	BY	CK	P.E. STAMPED BY	P.E. No.	Professional Engineer Seal

DESIGNED PEI	NEW ENGLAND CLEAN ENERGY CONNECT PROPOSED KENNEBEC RIVER CROSSING CONCEPTUAL TRANSMISSION LINE ROUTE MAP WEST FORKS PLT & MOXIE GORE, MAINE
DRAWN PEI	
CHECKED PEI	
APPROVED PEI	
REVIEWED	
CENTRAL MAINE POWER COMPANY SYSTEM ENGINEERING 	SK-KR-RTE-MAP-OP1 REV A

CENTRAL MAINE POWER DATE: 10/9/17 SCALE: AS NOTED

November 20, 2017

CENTRAL MAINE POWER

±320 kV HVDC UG Transmission Line Termination Stations Kennebec River Crossing

Reliability Assessment

PROJECT NUMBER:
147483

PROJECT CONTACT:
JESSE SAWIN
LES HINZMAN
MARK REYNOLDS

EMAIL:
JESSE.SAWIN@POWERENG.COM
LES.HINZMAN@POWERENG.COM
MARK.REYNOLDS@POWERENG.COM

PHONE:
(207) 869-1443
(208) 788-0577
(503) 892-6733

Preliminary Reliability Assessment

PREPARED FOR: CMP

PREPARED BY:

MARK A REYNOLDS

(503) 892-6733

MARK.REYNOLDS@POWERENG.COM

APPROVED BY:

LES HINZMAN

(208) 788-0577

LES.HINZMAN@POWERENG.COM

DOCUMENT HISTORY		
DATE	BY	REVISION
09/29/17	Mark A Reynolds P.E.	A – Issued for Review
10/20/17	Mark A Reynolds P.E.	B – Issued for Review
11/20/17	Mark A Reynolds P.E.	C – Issued with Final Report

TABLE OF CONTENTS

Contents

1. GENERAL..... 1

1.1 PROJECT DESCRIPTION..... 1

 1.1.1 Project River Crossing Information Details 1

1.2 CORRESPONDENCE/PROJECT PERSONNEL..... 2

 1.2.1 POWER Engineers, Inc. 2

 1.2.2 CMP..... 2

2. ELECTRICAL DESIGN STANDARDS 3

2.1 SYSTEM REQUIREMENTS 3

2.2 ELECTRICAL CLEARANCES 3

2.3. ELECTRICAL CLEARANCE (+/- 320 HVDC) DESIGN AND WORKING CLEARANCES 4

HORIZONTAL AND VERTICAL SPACING FOR BUSES 4

3. ANALYSIS APPROACH 5

3.1 HVDC TERMINAL AVAILABILITY (VSC EASTERN INVERTER)..... 5

3.2 OVERHEAD TRANSMISSION LINE AVAILABILITY (EASTERN SEGMENT)..... 5

3.3 CABLE TERMINATION STATION AVAILABILITY (EASTERN STATION) 5

3.4 CABLE TERMINATION STATION AVAILABILITY (WESTERN STATION) 6

3.5 CABLE SEGMENT AVAILABILITY (RIVER CROSSING)..... 6

3.7 OVERHEAD TRANSMISSION LINE AVAILABILITY (WESTERN SEGMENT) 6

3.8 HVDC TERMINAL AVAILABILITY (VSC WESTERN RECTIFIER)..... 7

4.1 MTTF/MTTR ASSUMPTIONS..... 7

1. General

1.1 Project Description

The Central Maine Power (CMP) High Voltage Direct Current (HVDC) Transmission Line for the New England Clean Energy Connect (NECEC) Project is a ±320 kV HVDC overhead, single circuit or symmetrical monopole (2-line poles) transmission line capable of transferring 1,200 MW. The project is about 207 miles overall with approximately 145 miles within the US. The line extends through Western Maine from the Appalaches Substation in Thetford Mines, Quebec, Canada and terminates near Lewiston, Maine in the United States. CMP is considering a ±320-kV HVDC underground transmission line for the crossing of the Kennebec River.

The ±320-kV HVDC underground transmission line segment would be installed in lieu of an overhead river crossing span. The project would require two overhead-to-underground Cable Termination (Transition) Stations located near the Kennebec River. In order to achieve the 1,200 Megawatt (MW) rating, each pole will require a 2500 mm² (nearly equivalent to 5,000 kcmil) copper conductor, cross-linked polyethylene (XLPE) insulated underground cable. A spare cable would be installed that could be connected to either pole after only a brief outage should a cable or termination failure occur.

A Horizontal Directional Drill (HDD), approximately 2,900 feet in length and 360 feet in depth, would be utilized for the Kennebec River crossing to install a duct bank consisting of, at a minimum: three (3) ten-inch (10”) ducts, one (1) four-inch (4”) duct, and two (2) two-inch (2”) ducts (all HDPE).

- High Reliability Option (DC) with an inexpensive switching station: One (1) cable per pole at ±320 kV HVDC with (1) spare cable installed:
 - An installed spare cable
 - Necessary Switches to manually switch in the underground cable
 - Limited Access Road to access the switches
 - No control house/P&C equipment auxiliary services

1.1.1 Project River Crossing Information Details

Owner’s Name:	Central Maine Power
Project Name:	NECEC Program, Kennebec River Crossing
Project Location:	Maine
Length:	Approximately 4400 feet (First estimate, subject to change)
Voltage:	±320 kV HVDC
Planned Energization Date:	TBD

1.2 Correspondence/Project Personnel

1.2.1 POWER Engineers, Inc.

Project Manager Russ Clavette
Email: russ.clavette@powereng.com
Phone: (207) 869-1202
Address: 303 US Route One
 Freeport, ME 04032

Project Engineer Jesse Sawin
Email: jesse.sawin@powereng.com
Phone: (207) 869-1443
Address: 303 US Route One
 Freeport, ME 04032

Project Engineer
(Transition Station) Mark Reynolds
Email: mark.reynolds@powereng.com
Phone: (503) 892-6733
Address: 9320 SW Barbur Blvd, Suite 200
 Portland, OR 97219

Project Engineer (UG) Les Hinzman
Email: les.hinzman@powereng.com
Phone: (208) 788-0577
Address: 3940 Glenbrook Dr.
 Hailey, ID 83333

1.2.2 CMP

Project Manager Justin Tribbet
Email: Justin.Tribbet@cmpco.com
Phone: (207) 629-2010
Address: 83 Edison Dr.
 Augusta, ME 04336

2. Electrical Design Standards

2.1 System Requirements

DESCRIPTION	Voltage Class System	
Maximum Phase-to-Phase Voltage	±320 kV	
Basic Impulse Level (BIL)	1300 kV	
Continuous Current, Main Bus	3000	
Ultimate Short Circuit	TBD kA	> 20 kA

2.2 Electrical Clearances

DESCRIPTION	Voltage Class System	
Operating Voltage	±320 kV	
BIL	1300 kV	
Minimum Metal to Metal for Phase to Phase: Recommended:	10'-10" 14'-0"	
Minimum Phase to Ground: Recommended:	9'-7" 11'-6"	
Station Post Insulator Height for Standard Strength	128"	
Min. Conductor Height for Safety:	18'-10"	
Vertical Clearance from Live Parts for Personnel Safety	20'-0"	
Horizontal Clearance from Live Parts for Personnel Safety	13'-4"	
Height of Conductor Over Roadway:	40'-0"	

Minimum Clearances based on IEEE Std 1427-2006

2.3. Electrical Clearance (+/- 320 HVDC) design and working clearances

Rated Maximum Phase to Phase voltage or Pole to Pole (kV) ⁽²⁾	BIL (KV) ⁽²⁾	Minimum Phase to Ground Clearances		Recommended Phase to Ground Clearances	Minimum Phase to Phase Clearances Metal to Metal	Recommended Phase to Phase Centerline Clearances		
		Rigid Parts (in)	Gap for Ground Switch to Live Parts ⁽³⁾ (in)	Rigid Parts (in)	Disc. Switch, Bus Supports, Rigid Conductors (in)	Vertical Break Disc. Switch, Bus Support ⁽⁵⁾ (in)	Horiz. Break Disc. Switch (in)	Horn Gap Switch (in)
±320	1300	104	50	110	155	192	240	240

(Per CMP Table 1 TM2.71.54 Standard with edit for HVDC Operation ± 320 kV)

Horizontal and Vertical Spacing for Busses

DESCRIPTION	Voltage Class System	
Operating Voltage	±320 kV	
BIL	1300 kV	
Low Bus Centerline, Phase to Phase	155 inches	
High Bus Centerline, Phase to Phase	155 inches	
Strain Bus Centerline, Phase to Phase	28'-0"	
Low Bus Height (minimum)	25'-0"	
High Bus Height (minimum)	41'-0"	

3. ANALYSIS APPROACH

3.1 HVDC Terminal Availability (VSC Eastern Inverter)

Current VSC HVDC technology offers overall station availabilities in the range of ~99.5 %, total terminal availability. Symmetrical bi-pole availabilities are different than LCC conventional Terminals due to the characteristics of not being able to fall back to a metallic or earth return configuration during the outage of one pole conductor. So, a single pole disturbance will create an instantaneous Bipole outage. Equipment outages will be predominately AC-equipment caused, including outages of significant voltage reductions to cause commutation failure of the rectifier/inverter converters.

3.2 Overhead Transmission Line Availability (Eastern Segment)

±320 kV HVDC transmission line design should provide an overall reliability figure that is only impaired for lightning caused events. As stated earlier a single line pole outage will result in a full system interruption, due to no fallback to metallic return or ground return configurations. Conservative selection of transmission line HVDC insulators with large creepage lengths (> 50 kV/mm) should provide adequate performance for natural pollution (dust) and unequal wetting, or large rainfall wetting of the outdoor insulation. The probability of outages in this segment will most likely be lightning produced outages, of a temporary nature that in most all cases will self-restore. Statistically about 5 to 7 lightning events may be expected, and each of these events will cause a momentary Bipole loss and reclose events of the range of 1.1 to 1.5 second duration, depending on the line clearing times, cable capacitance and length and where the fault was detected.

Automatic reclosure of the OH line segments would normally occur if there was no faults detected at either of the cable termination stations with both protection channels. If a cable fault was detected the automatic reclosure and startup process would be blocked until the cable termination data could be analysed and a decision made on restarting the energization process. The logic checks for the protection would normally occur in less than 20 to 50 MS, but the release of the blocking signal would normally require resetting appropriate lockouts at the HVDC Terminals and both the Cable Termination Stations. This can be done via SCADA supervisory control, but would still require human intervention, so several minutes 30 to 60 minutes may be spent obtaining fault records and verifying all of the switching (if backup pole cables are available) are properly configured.

3.3 Cable Termination Station Availability (Eastern Station)

The ±320 kV HVDC Cable Termination Station has several elements** that will determine the overall link availability. In order to assess this risk consider the joint probability:

- | | | |
|----|--|--|
| 1. | Incoming HVDC Cable Bushing (vertical) | λ_B (Bushing) = 0.0053 (Failures/yr) |
| 2. | Support Insulators and buswork | λ_{BUS} (System) = 0.0001 (Failures/yr) |
| 3. | MOV (Arrestor) | λ_{MOV} (Arrestor) = 0.0001 (Failure/yr) |
| 4. | Disconnect Switch | λ_{DISC} (Disc) = 0.0097 (Failures/yr.) |

**Data extracted from available *CIGRE failure data 2014*)

Failure Probability of one Current Path

$$P_{\text{pole}} = (1 - \lambda_B) * (1 - \lambda_{\text{BUS}}) * (1 - \lambda_{\text{MOV}}) * (1 - \lambda_{\text{DISC}}) =$$

$$P_{\text{pole}} = (0.9903) * (0.9999) * (0.9999) * (0.9903) = 0.9805 \text{ /year or}$$

$$(0.0195 \times 8760 \text{ hrs/year}) = 170 \text{ (hours of potential outage time)}$$

3.4 Cable Termination Station Availability (Western Station)

The ±320 kV HVDC Cable Termination Station has several elements** that will determine the overall link availability. In order to assess this risk consider the joint probability:

- | | |
|---|--|
| 6. Incoming HVDC Cable Bushing (vertical) | $\lambda_B(\text{Bushing}) = 0.0053$ (Failures/yr.) |
| 7. Support Insulators and buswork | $\lambda_{\text{BUS}}(\text{System}) = 0.0001$ (Failures/yr.) |
| 8. MOV (Arrestor) | $\lambda_{\text{MOV}}(\text{Arrestor}) = 0.0001$ (Failure/yr.) |
| 9. Disconnect Switch | $\lambda_{\text{DISC}}(\text{Disc}) = 0.0097$ (Failures/yr.) |

**Data extracted from available *CIGRE failure data 2014*

Failure Probability of one Current Path

$$P_{\text{pole}} = (1 - \lambda_B) * (1 - \lambda_{\text{BUS}}) * (1 - \lambda_{\text{MOV}}) * (1 - \lambda_{\text{DISC}}) =$$

$$P_{\text{pole}} = (0.9903) * (0.9999) * (0.9999) * (0.9903) = 0.9805 \text{ /year or}$$

$$(0.0195 \times 8760 \text{ hrs/year}) = 170 \text{ (hours of potential outage time)}$$

3.5 Cable Segment Availability (River Crossing)

From publically available sources of about 99.5 % (see section 4.2 below)

3.7 Overhead Transmission Line Availability (Western Segment)

From publically available sources availability of about is assumed 99.977 % (see section 4.2 below)

3.8 HVDC Terminal Availability (VSC Western Rectifier)

Assuming that the rectifier station has the same technology as the Eastern Inverter Station, Current VSC HVDC technology offers overall station availabilities in the range of ~99.5 %, total terminal availability. Symmetrical bi-pole availabilities are different than LCC conventional Terminals due to the characteristics of not being able to fall back to a metallic or earth return Configuration during the outage of one pole conductor. So, a single pole disturbance will create an instantaneous Bipole outage. Equipment outages will be predominately AC-equipment caused, including outages of significant voltage reductions to cause commutation failure of the rectifier/inverter converters.

4. OVERVIEW SYSTEM AVAILABILITY

4.1 MTTF/MTTR Assumptions

The HVDC VSC Inverter and Rectifier terminals are described and not under this part of the project scope. However, several assumptions were made to make the reliability estimates in this report, and are in summary below:

- a. MTTF/MTTR are heavily influenced by the ability to have the appropriate trained staff, protected spare parts available to the maintainers/repair staff, and full observable of the remote HVDC Cable Termination Stations. Video surveillance combined with full alarm and control point observability from both HVDC Terminal Stations will provide in most cases the means to diagnose any cable or transmission line impairments, and allow system operators to make the proper operating decisions.
- b. VSC operation during fault recovery needs to be completely tested during FAT (Factory System Testing) and should be tested and timing during all possible impairments. Of particular interest is how long the automated fault location, isolation and reconfiguration process will take (along with the HMI reaction delays)
- c. Due to weather conditions at the Cable Termination Stations during the weather, strategically located parts need to be warehoused either on site or at the nearest convenient township in a protected, secured, and accessible (7 x 24) location.

Spares should consist of at least the following parts for the cable termination station

- Spare insulators for all support and Disconnects
- Spare MOV surge arrestor
- Spare cable splice kits and re-termination kit
-

4.2 Combined Cable System Reliability Figure

The HVDC SC Inverter and Rectifier joint availability is about (according to recent discussions with OEM Suppliers):

99.0 %

Each Cable Termination Station has an availability calculated from typical values (as shown in the report):

98.04 %

Or a joint probability of $(0.9804)^2 = 0.9614$ or about 96.14 %.

The cable segment should have a reliability

of: $(1.0 - 0.0050) = 0.995$ or about 99.5 %

The overhead line segments have not been evaluated in this report but typical high performance ± 320 kV HVDC lines with conservative insulation systems should be in the order of:

Line length of 145 miles (figure the typical outage of 1 outage per 100 miles), so:

$145/100 = 1.45$ outages per year (from all causes but most probably lightning)

The usual approach is to round off to the next whole number of in this case 2.0 outages per year or:

$2/8760 = 0.000228$ (assuming short < 1 hour) duration self clearing faults or 0.0028 % per year or in availability $1.0 - 0.000228 = 99.977$ %

So, an overall availability (without considering MTTR (Mean Time to Repair) :

$(\text{OH Line Segment}) * (\text{Cable Segment}) * (\text{Termination Stations}) * (\text{HVDC Stations})$

$(0.9997) * (0.995) * (0.9614) * (0.990) = 0.9467$ or about **467 hours of unavailability (worst case) per year for self-restored faults.**

If we use figures on typical restoration activities than a MTTR can be calculated, however please note that HVDC cable faults are usually if not always non-restorable without removal and replacement of at least one of the pole conductors. (Please see other documents on MTTR estimates)

4.3 MTTR Considerations for UG Repair* (from POWER's Cable Specialists)**

In the event of a cable failure: 26 to 29 days; best case scenario, no contingency.

Mobilize Electrical Contractor, isolate the failed cable: 1-2 days

Remove terminations using man-lift and remove cable end to end – 3 days

Proof conduit and camera inspection of duct system – 3 days

If conduit is damaged and the spare must be used; time for routing spare to damaged cable termination position – 8 to 10 days

Replace a cable between termination structures – 2 days

Install terminations – 6 days

Test and energize – 3 days

In the event of a termination failure: 19 - 20 days; best case scenario, no contingency, assumes no civil work.

Mobilize Contractor, isolate the failed cable: 1-2 days

Mobilize UG T-Line Contractor with equipment: 5 days

Remove termination using man-lift and cable to pull-through vault – 2 days

Replace a short piece of cable between the pull-through vaults to the termination structure – 2 days

Install termination – 3 days

Install splice – 3 days

Test and energize – 3 days

***Assuming no installed spare cable. Spare materials are stored on site and an agreement would be in place for Contractors to mobilize immediately; no inclement weather or poor access conditions have been considered.

NOTE: This scenario explored in 4.3 above illustrates why CMP elected to install a spare cable in the final report

November 20, 2017

CENTRAL MAINE POWER

±320 kV HVDC UG Transmission Line Kennebec River Crossing

Design Information Package

PROJECT NUMBER:
147483

PROJECT CONTACT:
LES HINZMAN **EMAIL:**
LES.HINZMAN@POWERENG.C
OM PHONE:
(208) 788-0577



Design Information Package

PREPARED FOR: CMP

PREPARED BY:

LES HINZMAN
(208) 788-0577
LES.HINZMAN@POWERENG.COM

APPROVED BY:

-
-
-

DOCUMENT HISTORY		
DATE	BY	REVISION
09/11/17	Les Hinzman	A – Issued for Review
09/29/17	Les Hinzman	B – Issued for Review
10/20/17	Les Hinzman	C – Issued for Review
11/20/17	Les Hinzman	D – Issued with Final Report

TABLE OF CONTENTS

1.0 GENERAL 1

1.1 PROJECT INFORMATION 1

1.2 CORRESPONDENCE/PROJECT PERSONNEL..... 1

 1.2.1 POWER Engineers, Inc. 1

 1.2.2 CMP..... 1

1.3 PROJECT DESCRIPTION..... 2

2.0 ROUTE DESCRIPTION 2

2.1 ROUTE 2

2.2 MINIMUM EASEMENT REQUIREMENTS 3

3.0 UNDERGROUND SYSTEM PARAMETERS 3

3.1 CABLE SYSTEM OPERATING PARAMETERS 3

3.2 UNDERGROUND CABLE INSTALLATION PARAMETERS..... 3

 3.2.1 XLPE Cable System (Open Trench and HDD) 3

4.0 ELECTRICAL SYSTEM DESIGN CRITERIA 4

4.1 CODES AND STANDARDS 4

4.2 UNDERGROUND CABLE AND ACCESSORIES 4

 4.2.1 Cable..... 4

 4.2.2 Cable Splices 4

 4.2.3 Splice Manholes (Pull-through)..... 5

1.0 GENERAL

1.1 Project Information

Owner's Name: Central Maine Power
Project Name: NECEC Program, Kennebec River Crossing
Project Location: Maine
Length: Approximately 4400 feet
Voltage: ±320 kV HVDC
Planned Energization Date: TBD

1.2 Correspondence/Project Personnel

1.2.1 POWER Engineers, Inc.

Project Manager Russ Clavette
Email: russ.clavette@powereng.com
Phone: (207) 869-1202
Address: 303 US Route One Freeport, ME 04032

Project Engineer (Stations) Jesse Sawin
Email: jesse.sawin@powereng.com
Phone: (207) 869-1443
Address: 303 US Route One
Freeport, ME 04032

Project Engineer (UG) Les Hinzman
Email: les.hinzman@powereng.com
Phone: (208) 788-0577
Address: 3940 Glenbrook Dr.
Hailey, ID 83333

Project Engineer (Transition Station) Mark Reynolds
Email: mark.reynolds@powereng.com
Phone: (503) 892-6733
Address: 9320 SW Barbur Blvd, Suite 200
Portland, OR 97219

1.2.2 CMP

Project Manager Justin Tribbet
Email: Justin.Tribbet@cmpco.com
Phone: (207) 629-2010
Address: 83 Edison Dr.
Augusta, ME 04336

1.3 Project Description

The Central Maine Power (CMP) High Voltage Direct Current (HVDC) Transmission Line for the New England Clean Energy Connect (NECEC) Project is a ± 320 kV HVDC overhead, single circuit or symmetrical monopole (2-line poles) transmission line capable of transferring 1,200 MW. The project is about 207 miles overall with approximately 145 miles within the US. The line extends through Western Maine from the Appalaches Substation in Thetford Mines, Quebec, Canada and terminates near Lewiston, Maine in the United States. CMP is considering a ± 320 -kV HVDC underground transmission line for the crossing of the Kennebec River.

The projects includes two Cable Termination Substations near the Kennebec River. A planned 2,900 foot Horizontal Directional Drill would be utilized with 1500 feet of direct buried concrete encased duct bank consisting of three (3) ten-inch (10") ducts one (1) four-inch (4") duct, and two (2) two-inch (2") ducts (all HDPE) for the crossing of the Kennebec River with two (2) poles and an installed spare for the ± 320 kV HVDC underground transmission line to include ducts for fiber optic cables and distributed temperature sensing.

- High Reliability Option (DC) with an inexpensive switching station: One (1) cable per pole at ± 320 kV HVDC with (1) spare cable installed:
 - An installed spare cable
 - Necessary Switches to manually switch in the underground cable
 - Limited Access Road to access the switches
 - No control house/P&C equipment auxiliary services

2.0 ROUTE DESCRIPTION

A Horizontal Directional Drill (HDD), approximately 2,900 feet in length and 360 feet in depth, would be utilized for the Kennebec River crossing to install a duct bank consisting of, at a minimum: three (3) ten-inch (10") ducts, one (1) four-inch (4") duct, and two (2) two-inch (2") ducts (all HDPE).

It is anticipated that the HDD could be accomplished with a thirty-six inch (36") bore annulus within the proposed overhead transmission line corridor, which is 300 feet in width. The bore would pass beneath the Kennebec River with approximately thirty-feet (30') of clearance from the river bottom.

The HVDC underground cable installation would require approximately fifteen-hundred feet (1500') of open trenching to connect to the Cable Termination Stations.

2.1 Route

Approx. 2900’ drill with approximately 1,500’ open trench.

2.2 Minimum Easement Requirements

Property Easement: 300’ existing easement intended for overhead transmission line

3.0 UNDERGROUND SYSTEM PARAMETERS

3.1 Cable System Operating Parameters

The underground cable system will be operated under the following requirements:

Nominal Voltage	±320 kV
Nominal Frequency	DC
Maximum Steady State Load	1200 MVA

3.2 Underground Cable Installation Parameters

The cable system will require a horizontal directional drill with open trenching leading a transition station on either side.

3.2.1 XLPE Cable System (Open Trench and HDD)

The majority of the overall route will be installed using open cut trenching construction methods. The open cut trenching construction will be designed based on the following criteria.

Minimum Burial Depth to Top of Conduit	36 inches
Minimum Sweep Radius	12 feet
Ambient Soil Temperature (Assumed)	6°C
Native Soil Thermal Resistivity (Assumed)	80°C-cm/W at 6% moisture
Bentonite Drilling Fluid Thermal Resistivity (Assumed)	140°C-cm/W at 6% moisture

4.0 ELECTRICAL SYSTEM DESIGN CRITERIA

4.1 Codes and Standards

The system electrical design for the underground lines shall be in accordance with the latest revision of all applicable industry codes and standards as well as applicable regulations of the Federal, State, and Local authorities.

The following codes that will be used are as follows:

- National Electrical Safety Code 2017
- AEIC CS9-2015
- Cigre TB-496-2012
- ICEA S-108-720-2012
- ICEA P-45-482-2007
- IEC 62067-2011

4.2 Underground Cable and Accessories

This section describes the cable and accessories that will be used for the underground electrical system. All accessories will be designed and verified to accommodate the cable construction described below via a qualified type test in accordance with IEC 141-1

4.2.1 Cable

Cable Type (Solid Dielectric, HPFF, etc.)	Solid Dielectric
Voltage Class	±320 kV HVDC
Conductor Size	2,500 mm ²
Conductor Type and Construction	Compact segmented or circular copper
Insulation Material	XLPE
Insulation Thickness	21.5 mm (approx.)
Shield Type	Copper Laminate
Jacket Type	HDPE
Fault Current Magnitude	TBD
Fault Current Duration	TBD
Minimum Bend Radius	TBD
Supplied by	TBD

4.2.2 Cable Splices

Splice Style	TBD
Voltage Class	±320 kV HVDC
Quantity	(Spares TBD)
BIL	1300 kV

Supplied by TBD
Comments: Cable splices are not required on initial installation; spare splices are to be kept in stores to avoid long lead-times.

4.2.3 Splice Manholes (Pull-through)

Splice Manhole Type (Precast or Cast in Place) Precast
Splice Manhole Size (L' x W' x H' outside) TBD
Number of Circuits per Manhole TBD
Number of Splicing Manholes 6 Pull-Through Vaults
Minimum Cover 24"
Number of Access Lids 2
Vault Spacing TBD
Vault Loading Requirements (H-20, etc.) H-20
Supplied by Underground Civil Contractor
Comments

November 20, 2017

CENTRAL MAINE POWER

±320 kV HVDC UG Transmission Line Termination Stations Kennebec River Crossing

Design Criteria Package

PROJECT NUMBER:
147483
PROJECT CONTACT:
MARK REYNOLDS
EMAIL:
MARK.REYNOLDS@POWERENG.COM
PHONE:
(503) 892-6733

PROJECT CONTACT:
LES HINZMAN **EMAIL:**
LES.HINZMAN@POWERENG.C
OM PHONE:
(208) 788-0577



Preliminary Design Criteria Package

PREPARED FOR: CMP

PREPARED BY:

MARK A REYNOLDS

(503) 892-6733

MARK.REYNOLDS@POWERENG.COM

APPROVED BY:

-
-
-

DOCUMENT HISTORY		
DATE	BY	REVISION
09/21/2017	Mark A Reynolds P.E.	A – Issued for Review
09/22/2017	Mark A Reynolds P.E.	B – Revised from first comments
10/19/2017	Mark A Reynolds P.E.	C – Revised to final option
11/20/2017	Mark A Reynolds P.E.	D – Issued with Final Report

TABLE OF CONTENTS

Contents

1. GENERAL 1

1.1 PROJECT DESCRIPTION 1

 1.1.1 Project River Crossing Information Details 1

1.2 CORRESPONDENCE/PROJECT PERSONNEL 2

 1.2.1 POWER Engineers, Inc. 2

 1.2.2 CMP..... 2

2. CODES AND STANDARDS 3

2.1 TRANSMISSION STANDARDS INCLUDING CLIMATE & ENVIRONMENTAL DOCUMENTS 3

3. ELECTRICAL DESIGN STANDARDS 4

3.1 SYSTEM REQUIREMENTS 4

3.2 ELECTRICAL CLEARANCES..... 4

13. ELECTRICAL CLEARANCE (+/- 320 HVDC), DESIGN AND WORKING CLEARANCES..... 5

3.3 HORIZONTAL AND VERTICAL SPACING FOR BUSES..... 5

4. ELECTRICAL DESIGN PARAMETERS 5

4.1 RIGID BUS 5

4.2 JUMPER BUS 6

4.3 STRAIN BUS..... 6

5. STRUCTURES 6

6.0 FOUNDATIONS AND CONCRETE 6

6.1 FOUNDATION TYPE & APPLICATION 6

6.2 FOUNDATION DESIGN PARAMETERS..... 7

6.3 CONCRETE & ANCHOR BOLTS 7

7. GROUNDING..... 7

7.1 GROUND GRID DESIGN REQUIREMENTS 8

8. FENCING 8

8.1 MAIN FENCE TYPE & MATERIAL..... 9

9. LOW VOLTAGE CABLE (600V & BELOW)..... 9

9.1 CONTROL CABLE 9

9.2 FIBER OPTIC ADSS/DIELECTRIC CABLE 9

10. CONDUIT & CABLE TRENCH REQUIREMENTS 9

10.1 CABLE TRENCH 9

10.2 CONDUIT SYSTEM..... 10

10.3 SPLICE VAULTS (PULL-THROUGH & OTHER APPLICATIONS)..... 10

11. SUBSTATION LIGHTING..... 10

12.	SUBSTATION LIGHTNING PROTECTION.....	11
13.	WIND LOADING CRITERIA.....	11
14.	MAXIMUM ICING (RADIAL COATING TO ASSUME).....	11
15.	EXPECTED LIGHTNING PROBABILITIES	11
16.	POLLUTION LEVELS (INCLUDING DUST BORNE CAUSED)	11
17.	TEMPERATURE EXTREMES	12
18.	HUMIDITY EXTREMES	12
19.	SNOWFALL MAXIMUM.....	12
20.	RAINFALL MAXIMUM.....	12
21.	SEISMIC LEVELS (IEEE 693, MOST PROBABLY “LOW PERFORMANCE” IN THIS LOCATION).....	13
22.	OIL CONTAINMENT (AS PERTAINING TO DOUBLE WALL ALARMED OIL STORAGE TANK SYSTEM)	13
23.	STATION SECURITY VIDEO SURVEILLANCE, AND INTRUSION ALARMING.....	14
24.	TELECOMMUNICATIONS & PROTECTION & CONTROL OVERVIEW	14
25.	PREFABRICATED SUBSTATION BUILDINGS (EEE) & ASSOCIATED AUXILIARY POWER SYSTEMS	14

1. General

1.1 Project Description

The Central Maine Power (CMP) High Voltage Direct Current (HVDC) Transmission Line for the New England Clean Energy Connect (NECEC) Project is a ± 320 kV HVDC overhead, single circuit or symmetrical monopole (2-line poles) transmission line capable of transferring 1,200 MW. The project is about 207 miles overall with approximately 145 miles within the US. The line extends through Western Maine from the Appalaches Substation in Thetford Mines, Quebec, Canada and terminates near Lewiston, Maine in the United States. CMP is considering a ± 320 -kV HVDC underground transmission line for the crossing of the Kennebec River.

The project includes two Cable Termination Substations near the Kennebec River. A planned 2,900 foot Horizontal Directional Drill would be utilized with 1500 feet of direct buried concrete encased duct bank consisting of three (3) ten-inch (10”) ducts one (1) four-inch (4”) duct, and two (2) two-inch (2”) ducts (all HDPE) for the crossing of the Kennebec River with two (2) poles and an installed spare for the ± 320 kV HVDC underground transmission line to include ducts for fiber optic cables and distributed temperature sensing.

High Reliability Option (DC) with an inexpensive switching station: One (1) cable per pole at ± 320 kV HVDC with (1) spare cable installed:

- An installed spare cable
- Necessary Switches to manually switch in the underground cable
- Limited Access Road to access the switches
- No control house/P&C equipment auxiliary services

1.1.1 Project River Crossing Information Details

Owner’s Name:	Central Maine Power
Project Name:	NECEC Program, Kennebec River Crossing
Project Location:	Maine
Length:	Approximately 4400 feet (First estimate subject to change)
Voltage:	± 320 kV HVDC
Planned Energization Date:	TBD

1.2 Correspondence/Project Personnel

1.2.1 POWER Engineers, Inc.

Project Manager
Russ Clavette
Email: russ.clavette@powereng.com
Phone: (207) 869-1202
Address: 303 US Route One Freeport, ME 04032

Project Engineer
(Stations)
Jesse Sawin
Email: jesse.sawin@powereng.com
Phone: (207) 869-1443
Address: 303 US Route One
Freeport, ME 04032

Project Engineer
(Transition Station)
Mark Reynolds
Email: mark.reynolds@powereng.com
Phone: (503) 892-6733
Address: 3 Centerpointe Drive Suite 500
Lake Oswego, OR 97035-8663

Project Engineer
(Underground T-Line) Email:
Les Hinzman
Email: les.hinzman@powereng.com
Phone: (208) 788-0577
Address: 3940 Glenbrook Dr.
Hailey, ID 83333

1.2.2 CMP

Project Manager
Justin Tribbet
Email: Justin.Tribbet@cmpco.com
Phone: (207) 629-2010
Address: 83 Edison Dr.
Augusta, ME 04336

2. Codes and Standards

2.1 Transmission Standards including Climate & Environmental Documents

A summary of the codes, industry standards, and guides to be used are included below, including IEEE Standards and Owner Specific Standards (as available).

AASHTO	American Association of State and Highway Transportation Officials
ACI	American Concrete Institute
AGA	American Galvanizers Association
AISC	American Institute of Steel Construction
ANSI	American National Standards Institute
ASCE	American Society of Civil Engineers
ASME	American Society of Mechanical Engineers
ASTM	American Society for Testing and Materials
AWS	American Welding Society
CFR	Code of Federal Regulations
IBC	International Building Code
IEC	International Electrotechnical Commission
IEEE	Institute of Electrical and Electronics Engineers
MBC	Minnesota Building Code
MBMA	Metal Building Manufacturers Association
NEC	National Electric Code, 2014 Edition
NEMA	National Electrical Manufacturers Association
NESC	National Electric Safety Code, C2-2012
NFPA	National Fire Protection Association
OSHA	Occupational Safety and Health Organization

The current revision of all relevant standards shall apply (unless otherwise noted) including:

AASHTO:	Standard for Aggregates
ANSI:	C2 – National Electrical Safety Code (2012)
ASCE:	113 – Substation Structure Design Guide (2008)
IEEE:	80 – Guide for Safety in AC Substation Grounding
	525 – Guide for the Design and Installation of Cable Systems in Substations
	605 – Guide for Design of Substation Rigid Bus Structures
	693 – Recommended Practice for Seismic Design of Substations
	998 – Guide for Direct Lightning Stroke Shielding of Substations
NFPA:	70 – National Electric Code
MBC:	Maine Building Code (2015 or latest edition)
OSHA:	1910.269 – Electric Power Generation, Transmission, and Distribution, Law and Regulations
IEC	IEC 60815 Guide for the Selection of Insulators in Respect of Polluted Levels

The current revision of all relevant standards form CMP shall apply (unless otherwise noted) including:

<p>CMP TM 2.71.345 CMP 2.72.64 CMP 2.72.65-103</p> <p>CMP 2.71.9 (Series)</p> <p>CMP TM 2.71.08 (Rev 2) CMP TM 2.73.19</p> <p>CMP TM 2.71.11</p> <p>CMP TM 2.71.77</p> <p>CMP TM 2.71.54</p> <p>CMP TM 2.71.53</p>	<p><i>CMP Structural Steel Standards</i> <i>CMP Structural Steel Standards</i> <i>CMP Structural Steel Standards</i></p> <p><i>CMP Foundations Standards</i></p> <p><i>CMP Control Building Standards</i> <i>CMP Control House Electrical Standards</i></p> <p><i>CMP Lighting Standards</i></p> <p><i>CMP Grounding Standards</i></p> <p><i>CMP Electrical Clearance Standards</i></p> <p><i>CMP Bus Design Standards</i></p>
--	--

3. Electrical Design Standards

3.1 System Requirements

DESCRIPTION	Voltage Class System	
Maximum Phase-to-Phase Voltage	±320 kV	
Basic Impulse Level (BIL)	1300 kV	
Continuous Current, Main Bus	3000 A	
Ultimate Short Circuit	TBD kA	> 20 kA

3.2 Electrical Clearances

DESCRIPTION	Voltage	
Operating Voltage	±320 kV	
BIL	1300 kV	
Minimum Metal to Metal for Phase to Phase: Recommended:	10'-10" 14'-0"	
Minimum Phase to Ground: Recommended:	9'-7" 11'-6"	
Station Post Insulator Height for Standard Strength	128"	
Min. Conductor Height for Safety:	18'-10"	
Vertical Clearance from Live Parts for Personnel Safety	20'-0"	
Horizontal Clearance from Live Parts for Personnel Safety	13'-4"	
Height of Conductor Over Roadway:	40'-0"	

Minimum Clearances based on IEEE Std 1427-2006

13. Electrical Clearance (+/- 320 HVDC), design and working clearances

Rated Maximum Phase to Phase voltage or Pole to Pole (kV) ⁽²⁾	BIL (KV) ⁽²⁾	Minimum Phase to Ground Clearances		Recommended Phase to Ground Clearances	Minimum Phase to Phase Clearances Metal to Metal	Recommended Phase to Phase Centerline Clearances		
		Rigid Parts (in)	Gap for Ground Switch to Live Parts ⁽³⁾ (in)	Rigid Parts (in)	Disc. Switch, Bus Supports, Rigid Conductors (in)	Vertical Break Disc. Switch, Bus Support ⁽⁵⁾ (in)	Horiz. Break Disc. Switch (in)	Horn Gap Switch (in)
±320	1300	104	50	110	155	192	240	240

(Per CMP Table 1 TM2.71.54 Standard with edit for HVDC Operation ± 320 kV)

3.3 Horizontal and Vertical Spacing for Busses

DESCRIPTION	Voltage	
Operating Voltage	±320 kV	
BIL	1300 kV	
Low Bus Centerline, Phase to Phase	155 inches	
High Bus Centerline, Phase to Phase	155 inches	
Strain Bus Centerline, Phase to Phase	28'-0"	
Low Bus Height (minimum)	25'-0"	
High Bus Height (minimum)	41'-0"	

4. ELECTRICAL DESIGN PARAMETERS

4.1 Rigid Bus

DESCRIPTION	VOLTAGE	
Nominal Voltage:	±320 kV	
Type (Tube, Other):	Al Tube	
Ampacity:	3000A	(CMP Standard)
Material / Alloy:	6063-T6	
Short Circuit Current:	TBD kA	> 20 kA

4.2 Jumper Bus

DESCRIPTION	VOLTAGE	
Nominal Voltage:	±320 kV	
Ampacity:	3000A	(CMP Standard)
Connections (Compression / Bolted / Welded):	TBD	

4.3 Strain Bus

DESCRIPTION	VOLTAGE	
Nominal Voltage:	±320 kV	
Ampacity:	3000A	(CMP Standard)
Connections (Compression / Bolted / Welded):	TBD	

5. Structures

Substation structural steel is to be designed in conformance with ASCE standards and per CMP Substation Standard Specification as listed. The design will consider shipping restrictions and minimize the need for special offloading equipment and provisions. Steel designs are to include all assembly hardware and anchoring systems (anchor bolts, rods, etc.) along with torque requirements.

6.0 FOUNDATIONS AND CONCRETE

6.1 Foundation Type & Application

Foundations will be designed to be in accordance with all relevant CMP design standards as listed. All station dead end foundations are primarily compression/uplift type foundations. The equipment support foundations are primarily laterally loaded (moment type) foundations. Slab type foundation will also be used as appropriate for equipment mounting.

6.2 Foundation Design Parameters

The foundation design shall consider the following soil properties for each soil layer

- Soil type
- Thickness of soil layer
- Soil density (unit weight)
- Soil friction angle
- Pressure meter Modulus
- Undrained shear strength
- Adhesion factor
- Cohesion
- Horizontal stress coefficient, k_0
- Depth to ground water (both at time of drilling and estimated high)

All foundations will be designed for a 6" minimum reveal above the top rock cover. All drilled pier foundations shall be designed according to the L-pile parameters provided in the geotechnical reports. The soil parameters provided are reduced to account for soil loosening resulting from frost dissipation to a depth of 6 feet. Due to the 72 inch frost depth all slab foundations will require soil correction in order to prevent frost heave. Soil correction will consist of either 6 ft. of non-frost susceptible fill, or 4" of foam insulation to be placed under the foundation. All CMP Standards listed shall apply, unless otherwise stated.

6.3 Concrete & Anchor Bolts

The concrete used in the foundations shall have a minimum 28-day compressive strength of 4,500 psi with a water to cement ratio not to exceed 0.45. Concrete placed under water shall have a minimum 28-day compressive strength of 5,000 psi. All concrete specifications, concrete design and reinforcing steel requirements shall be in accordance with the latest Minnesota adopted edition of the Building Code Requirements for Reinforced Concrete (ACI-318). All vertical reinforcing steel shall be ASTM A-615 Grade 60 and all lateral (hoops) reinforcing steel shall be ASTM A-615 Grade 60. A minimum of three inches (3 in.) of clear space is required from the outermost reinforcing steel to the side of the excavation. Cast in place anchor bolts shall be ASTM F1554 GR 36 or ASTM A615 Grade 75 deformed bars, threaded at the end(s). Epoxy anchor bolts shall be HILTI HIT HY200. (Refer to applicable CMP Standards)

7. Grounding

The substation grounding design shall provide a ground mat system consisting of main ground grid conductors, ground rods, grounding mats and structure ground stingers as necessary for a complete grounding installation. The substation grounding system for each installation will be designed to meet the recommendations defined in IEEE 80 and Owner design standards.

All equipment, cabinets, structures, fencing, gates are to be connected to the main ground grid. Below grade ground grid conductors shall be bonded at each joint and ground rod using either

exothermic connections or compression style connectors. Above grade connections to buildings, equipment, cabinets and structures shall use compression type connectors. Ground stinger connections shall be 4/0 minimum.

The grid design will be based on maximum available symmetrical fault current levels and a clearing time of 0.5 seconds. The acceptable limits for touch and step potential used in designing the grounding system shall be in accordance with IEEE 80. The grid design will be modeled in CDEGS. (Refer to applicable CMP Standards as listed)

7.1 Ground Grid Design Requirements

The substation ground grid shall meet the following minimum requirements: (Refer to applicable CMP Standards as listed)

- Main Ground grid will be made up of minimum 4/0 CU, 19 strand, soft drawn.
- Ground grid is to be buried eighteen inches (18 in.) below the top of sub grade (not including top rock)
- Ground grid will be installed three feet (3 ft.) outside the fence line perimeter.
- The ground grid must be extended at all entrance gates, so that the outermost ground conductor is always three feet (3 ft.) away from the extent of fence metalwork including gate swing areas.
- Ground rods shall be located and connected to the ground grid per design calculations.
- Ground rod length shall be determined by the ground grid design and geotechnical investigation.
- Dedicated ground rods are required at each set of surge arresters and at all shield wire attachment structures.
- Control building shall have two tinned or silver plated ground pads with NEMA 4-hole pads on opposite corners of the structure which are to be connected to the ground grid.
- Below grade copper mats shall be installed at each disconnect switch operator.
- A layer of minimum four inch (4 in.) deep crushed (not smooth rounded), washed rock, $\frac{3}{4}$ " to 1" grade, to be used throughout the substation area and up to five feet (5 ft.) beyond the fence boundary.
- Fence is to be connected to the main grid at all corners posts and every other line post. Fence is to be grounded using #4 CU, 7 strands, soft drawn.

8. Fencing

The substation yard will be secured with a chain link fence consisting of steel posts, a minimum of nine (9) feet of galvanized steel wire woven fabric in accordance with ASTM A392, Class 2 and at least three (3) strands of 12.5 USWG steel barbed wire in accordance with ASTM A121, Class 3. The gate and corner posts shall be imbedded six (6) feet into a concrete foundation. Line posts shall be direct driven. Gates shall be installed as required to allow ready access to qualified personnel and adequate turning radius for the equipment necessary to construct, maintain and operate the substation. The design and construction shall comply with MP and NESC requirements. Signage will be installed in accordance with NESC, ANSE Z535 and MP requirements. (Refer to applicable CMP Standards as listed)

8.1 Main Fence Type & Material

Fence Type (Type)	Chain Link
Fence Height	9 Ft (+1 ft barbed wire)
Fence Material (Type)	Galvanized Steel Fabric
Fence Foundation	Augured concrete Pier Perimeter Footing and direct driven
Drive Gates, Size, & Quantity	Two, 24'
Personnel Gates, Size, & Quantity	One, 4'

9. Low Voltage Cable (600V & Below)

All power and control cables (if required) shall be in accordance with CMP Standard Specifications Flame Retardant Power & Control Cable. (Refer to applicable CMP Standards as listed)

9.1 Control Cable

No active control cables are planned for this facility.

9.2 Fiber Optic ADSS/Dielectric Cable

All Fiber Optic Cables will be furnished and installed by other contractors and the specification requirements will be in other documents. (CMP Telecommunications Standards will be applied in this area)

10. CONDUIT & CABLE TRENCH REQUIREMENTS

10.1 Cable Trench

No cable trench is expected for the termination stations

10.2 Conduit System

A complete conduit system shall be provided to complete all routing needs for the cabling system. The minimum conduit size used in below grade applications shall be two inches (2 in). The minimum conduit size for above grade applications shall be one inch (1 in). Below grade conduits shall be PVC. Above grade conduits shall be Rigid Galvanized Steel (RGS) or Flexible Liquid Tight (Flex). Below grade elbows for risers shall be 90° RGS with a 24” minimum radius. All other below grade elbows shall be PVC with 24” minimum radius.

The conduits shall be installed with all appropriate hardware to meet NEC requirements and shall include lock nuts, joints/couplers, bell ends, watertight provisions, etc. as required to provide for a complete system. (Refer to applicable CMP Standards as listed)

10.3 Splice Vaults (Pull-through & other applications)

The cable and splice vaults will generally be part of the EHV cable installation contractors scope of work. It is envisioned that the vaults will be placed before major substation above grade work is completed. Salient features include:

- a. Splice Manhole Type (Precast or Cast in Place) Precast
- b. Splice Manhole Size (L' x W' x H' outside) TBD
- c. Number of Circuits per Manhole One pole or spare per manhole
- d. Number of Splicing Manholes 6 Pull-Through Vaults
- e. Minimum Cover 24”
- f. Number of Access Lids 2
- g. Vault Spacing TBD
- h. Vault Loading Requirements (H-20, as required determined by location)

11. Substation Lighting

No permanent active lighting systems are planned for these stations. Only temporary generator supplied portable lighting will be used during nighttime maintained operations.

12. Substation Lightning Protection

The substation shall be protected from lightning strokes to meet the Isokeraunic level. The stroke protection system shall consist of dead end structures, static masts, support hardware and shield wires directly connected to the ground grid. Shielding shall be based on the use of the rolling sphere analysis method per IEEE 998-2012, including failure probability as noted in Section 3 and Annex D. Shield wire routings shall be parallel to bus work whenever possible and routed to minimize main bus crossings.

Static wires shall be 7#7 Alumoweld steel electrically connected to the ground grid (either directly or via the terminating structure) on both ends of the static wire span. OPGW static wires will also be allowed for use as needed. All shield poles and dead ends used for shielding shall have a ground rod installed within three (3) feet of the structure with a minimum of two (2) separate connections between the structure the and the substation grounding. (Refer to applicable CMP Standards as listed)

13. Wind Loading Criteria

DESCRIPTION	MPH
Average Wind Speed: (Basic)	40
Highest Wind Maximum: (ASCE 7-16)	113
Gust Factor	TBD

14. Maximum icing (radial coating to assume)

DESCRIPTION	Inches Radial
Average	0.5
Highest Icing Maximum: (CMP Standard)	1.5
Highest Icing Maximum (ASCE 7-16)	1.0

15. Expected Lightning probabilities

TBD based on overall Transmission Line design parameters.

16. Pollution Levels (including dust borne caused)

Without any local condition information to fully determine the pollution including blowing dust at the two Termination Stations it has been assumed that the (per IEC 60815) that the following creepage lengths will be used:

Type of Insulation	Creepage Length
Porcelain Insulators/Bushings	50 mm/kV
Silicone Rubber Insulators/Bushings	40 mm/kV

17. Temperature extremes

DESCRIPTION	Temperature
Lowest (Centigrade)	-40° C
Highest Possible (Centigrade)	+40° C

18. Humidity Extremes

DESCRIPTION	
Average Low	61%
Highest Expected	82%
(needs further investigation at cable termination sites)	

19. Snowfall Maximum

DESCRIPTION	Inches/24 hours
Average	12
Highest Accumulation	40
(needs further investigation at the cable termination sites)	

20. Rainfall Maximum

DESCRIPTION	Inches/hr.
Average (15 minute Intensity)	4.39
Highest (60 minutes Intensity)	1.79

21. Seismic Levels (IEEE 693, most probably “low performance” in this location)

The local Seismic levels in accordance with USGS Mapping appear to be classified as an IEEE 693 “LOW PERFORMANCE” (for “Essential Facilities”). This level of seismic performance may be modified after detailed geotechnical investigations are completed.

Building Code Reference Document 2012/2015 International Building Code
(which utilizes USGS hazard data available in 2008)
Site Coordinates 45.34696°N, 69.95856°W
Site Soil Classification Site Class B - “Rock”
Risk Category IV (e.g. essential facilities)



USGS-Provided Output

$S_s = 0.202\text{ g}$ $S_{M1} = 0.202\text{ g}$ $S_{M2} = 0.134\text{ g}$
 $S_1 = 0.082\text{ g}$ $S_{M1} = 0.082\text{ g}$ $S_{M2} = 0.055\text{ g}$

For information on how the S_s and S_1 values above have been calculated from probabilistic (risk-targeted) and deterministic ground motions in the direction of maximum horizontal response, please return to the application and select the “2009 NEHRP” building code reference document.

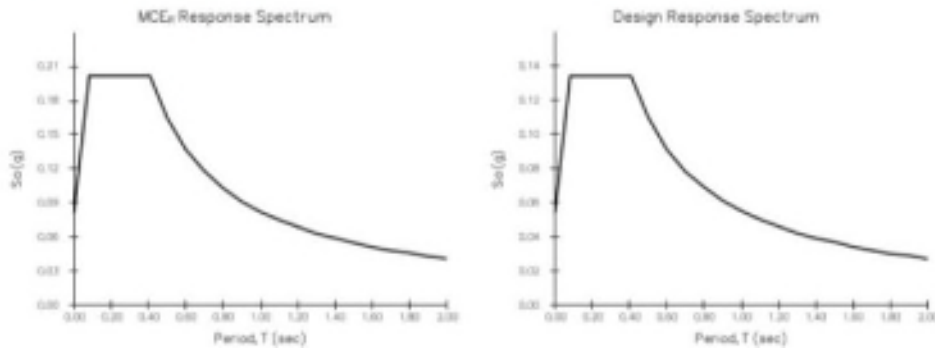

22. Oil containment (as pertaining to double wall alarmed oil storage tank system)

No active oil storage or containment systems are planned for these termination stations.

23. Station security video surveillance, and intrusion alarming

No active security measures are planned for these stations.

24. Telecommunications & Protection & Control Overview

No active telecommunications or protection equipment is planned for these stations. Passive cable fault locators will be utilized on each cable termination.

25. Prefabricated Substation Buildings (EEE) & Associated Auxiliary Power Systems

No Buildings are planned for this station development at this time.