

STATE OF MAINE

Traffic Crash

Reporting Manual



Produced and Distributed by:
Maine Department of Public Safety
Maine State Police Traffic Safety Unit
36 Hospital Street
Augusta, Maine 04333
Telephone (207) 624-8939
Fax (207) 624-8945

www.informe.org/mcrs

Revised August 2010

Forward

In 2003, with the implementation of the Maine Crash Reporting System (MCRS), Maine became the first state in the Nation to collect all crash data from investigating police departments electronically with no data entry. Maine was able to improve the timeliness and accuracy of crash data being submitted to the state database.

In 2006 the National Highway Traffic Safety Administration (NHTSA) conducted an assessment of Maine's traffic records. The purpose of the assessment was to determine whether Maine's traffic records system is capable of supporting management's needs to identify the state's safety problems, to manage the countermeasures applied to reducing or eliminating those problems, and to evaluate those programs for their effectiveness.

At the same time Maine Legislature mandated the addition of data fields on the crash form to collect more detailed data regarding "Distracted Drivers."

As a result of the NHTSA assessment and Legislative mandates, Maine's Traffic Records Coordinating Committee (TRCC) felt it was time to review our crash form for improvements and increased compliance with the Minimum Model Uniform Crash Criteria (MMUCC), as there has not been a major change in structure in approximately fifteen years. Even though the crash report system was moved to an electronic format seven years ago, the actual form and content were not significantly changed.

Maine's TRCC tasked a committee to review the crash report form and make recommendations for changes aimed at improving crash data collection processes, quality, accuracy, timeliness, MMUCC compliance and data sharing capabilities of users. Committee members included members of the Maine State Police, Local Police Departments, Maine Department of Transportation, Users of Information Management Corporation (IMC), Deep River LLC, Bureau of Motor Vehicles, and the Maine Warden Service.

The committee's work resulted in a complete revision of Maine's crash form and operating functionality. The purpose is to improve the overall quality, accuracy, and timeliness of crash data being submitted to the state crash database.

The law enforcement officer is absolutely the most important element of the crash reporting system!

The data produced from approximately 35,000 traffic crash reports processed each year can be no better than the accuracy of the original reports submitted by Maine's law enforcement agencies. If the law enforcement officer completing the Traffic Crash Report does an incomplete or incorrect job of filling out the form, the resulting data will be of poor quality. As a result, traffic safety experts will be unable to evaluate public education campaigns, make improvements to roadways, and dangerous drivers will continue to pose a threat to all motorists.

If you have questions regarding Crash Reporting:

Contact the Maine State Traffic Safety Unit at (207)624-8944, 8952, or 8936

Acknowledgments

I would like to thank all those who assisted in rewriting the Maine Crash Reporting Manual. It is only through the tireless work, suggestions, and contributions by the following people that this manual was completed in a four month time period:

Lt. Brian Scott	Maine State Police Traffic Division
Sgt. Bruce Scott	Maine State Police Traffic Division
Tr. Angela Porter	Maine State Police Traffic Safety Unit
Tr. Darren Foster	Maine State Police Traffic Safety Unit
Sgt. Ricky Doyon	Biddeford Police Department
Lt. Shon Theriault	Maine Warden Service
Pat Plourde	Maine State Police Motor Carrier
Duane Brunell	Maine Department of Transportation
Greg Costello	Maine Department of Transportation
Jody Wisniewski	Maine Department of Transportation
Dan Schuessler	Deep River LLC

Sgt. Rick McAlister
Maine State Police
Traffic Safety Unit

Concept of the State of Maine Traffic Crash Report

This manual has been prepared to provide guidance for completion of the State of Maine Traffic Crash Report prescribed by the Colonel of the Maine State Police pursuant to the Maine Motor Vehicle Statutes Title 29-A Chapter 19, Subchapter 3 §2251-3. *For the purposes of this manual “collision” and “crash” are synonymous.*

This manual was designed and created to be used by all Maine law enforcement as an easy reference in order to promote timely, accurate, and consistent data capture resulting from motor vehicle crashes. There were several documents used as references during the creation of this manual including:

The Minimum Model Uniform Crash Criteria (MMUCC) www.mmucc.us MMUCC is a guideline, which represents a model minimum set of uniform variables or data elements for describing a motor vehicle traffic crash. MMUCC includes 77 data elements that need to be collected by law enforcement at the crash scene and an additional 34 data elements that can be derived from those that are collected at the scene or obtained by linking to other data files, e.g., driver history, injury, and roadway inventory data. MMUCC was originally developed in response to requests by states interested in improving and standardizing their state crash data, leading to more complete reporting with uniform data element attributes.

ANSI D16.1 - Manual on Classification of Motor Vehicle Traffic Accidents
http://downloads.nsc.org/pdf/D16.1_Classification_Manual.pdf

The D16.1 is a standard for classifying motor vehicle traffic accidents. The primary purpose of the D16.1 Manual is to promote uniformity and comparability of motor vehicle traffic crash data, being developed and used in states and local jurisdictions. The D16.1 Manual provides a common language for reporters, classifiers, analysts, and users of traffic crash data. D16.1 addresses distinguishing characteristics of motor vehicle traffic crashes to assist officers in determining whether or not an incident is a motor vehicle crash. For example, the officer would have to answer "yes" to each of the following questions, for it to be a motor vehicle crash.

- Did the incident include one or more occurrences of injury or damage?
- Was there at least one occurrence of injury or damage, which was not a direct result of a cataclysm?
- Did the incident involve one or more motor vehicles?
- Of the motor vehicles involved, was at least one in transport?
- Was the incident an unstabilized situation?
- Did the unstabilized situation originate on a trafficway or did injury or damage occur on a trafficway?

ANSI D20-2010 - Data Element Dictionary for Traffic Records Systems

<http://www.aamva.org/aamva/DocumentDisplay.aspx?id=%7B0287CE5F-165E-4855-93FE-5EEC2AF9AFB1%7D>

The D20.1 is a standard (Data Dictionary) for promoting uniformity in the transmission of records between jurisdictions in the following areas related to highway safety, driver licensing and vehicle registration.

- Motor vehicle registration and titling
- Driver licensing
- Highway inventory and traffic
- Crashes and emergency medical services
- Motor vehicle inspection
- Commercial drivers licensing
- Traffic law enforcement
- Motor vehicle insurance

Every reported crash must be promptly investigated. Every reasonable effort shall be made to obtain factual information for the completion of the report. If this is not possible, law enforcement shall use their best judgment and record their considered opinions based on their investigation and experience. This should be done even though it may not be possible to substantiate all recorded information or have sufficient evidence to initiate prosecution.

When prosecution is initiated, a police officer may issue a citation to a person who is a driver of a motor vehicle involved in a crash if, based upon PERSONAL INVESTIGATION; the officer has reasonable cause to believe that the person has committed a misdemeanor under the act or is responsible for a civil infraction in connection with the crash.

Each crash report is a display of the ability of the professional traffic crash investigator. Compliance with instructions in this manual will help ensure that reports are filled out completely, accurately, uniformly, and will be of the greatest possible value for crash prevention purposes.

The Maine Traffic Crash Report is not only for insurance companies! Data reported on the Maine crash form is used by:

- Traffic engineers to help redesign and upgrade roads and intersections.
- Law enforcement to assign patrols to roads where an unusually high number of crashes occur.

- Secretary of State to update driver records and get “problem” drivers off our roads.
- Federal safety agencies that develop safety initiatives, implement safety programs, and contribute to making and changing laws.

Accurate and timely data is important to everyone!

Click on the page number and the link will take you to the appropriate page.

Table of Contents

Forward	2
Acknowledgments	3
Concept of the State of Maine Traffic Crash Report	4
Table of Contents	7
Quick Reference	18
Location Page	18
Unit Page	19
Commercial Page	20
Coding Guide 1	21
Coding Guide 2	22
Coding Guide 3	23
Coding Guide 4	24
Coding Guide 5	25
Administrative Elements	26
Title 29-A §2251 Crash Reports.....	26
Definition.....	26
Form	27
Investigation	27
Special Circumstances	29
Crash Report Structure	32
Location Elements	32
Incident Information	32
ORI (Originating Agency Number).....	32

Click on the page number and the link will take you to the appropriate page.

Report Number	32
Crash Date	33
Crash Time	33
At Scene Date	33
At Scene Time	33
Location	34
Off Road or IFW	34
Type Location	34
City or Town	41
MAP.....	41
Street or Highway	41
Nearest Intersecting Street.....	42
Direction from Nearest Intersection	42
Distance and Units	42
Latitude and Longitude	43
Special Note for IMC User's	43
Environment.....	44
Posted Speed Limit	44
Type Crash.....	45
Weather Condition.....	49
Light Condition.....	50
Road Grade	51
Road Surface Condition	52
Traffic Control Device	53
Traffic Control Device Operational.....	56
Location of First Harmful Event	56
Damage Over Threshold	60

Click on the page number and the link will take you to the appropriate page.

Contributing Circumstances Environment 1 and 2..... 60

Contributing Circumstances Environment 2 61

Contributing Circumstance Road 1 and 2..... 61

Contributing Circumstance Road 2..... 62

In or Near a Work Zone 62

Work Zone Workers Present 64

Location Related to Work Zone 65

Type of Work Zone 67

Police Present at Work Zone 70

School Bus Related 70

Reporting Officer and Approval..... 73

 Officer Name 73

 Badge Number 73

 Report Date 74

 Add Comment..... 74

 Approved By 74

 Approved Date..... 74

Narrative 74

Officer Notes 74

Unit Elements..... 75

 Unit Identification 75

 Hit and Run..... 75

 Unit Type 75

 Motor Vehicle Identification Number (VIN) 82

 License Plate 82

 State 83

Vehicle Information 83

Click on the page number and the link will take you to the appropriate page.

Vehicle Make 83

Vehicle Year 83

Vehicle Color 83

Insurance 84

 No Insurance (check box)..... 84

 NAIC number (National Association of Insurance Commissioners)..... 84

 Insurance Company Name 84

 Policy Number 85

 Exempt Vehicle..... 85

Large Vehicle Information 86

 Hazmat Placarded 86

 Vehicle configuration 86

 GVWR (Gross Vehicle Weight Rating) or GCWR (Cross Combined Weight Rating)..... 91

 9 or More seats..... 92

Special Function Vehicle 93

 Special Function Vehicle 93

 Responding to Scene? 94

Damage 95

 Extent of Damage 95

 Most Damaged Area..... 96

Actions 98

 Vehicle Direction of Travel..... 98

 Most Harmful Event 100

 Pre-Crash Actions 110

 Contributing Circumstances Vehicle 113

 Sequence of Events 1, 2, 3, and 4..... 114

Person Elements..... 123

Click on the page number and the link will take you to the appropriate page.

Select Person Type	123
Person Type	123
License Info	124
License Status	124
License Number	125
License State	125
License Class	125
Endorsements	126
Restrictions	126
Name	126
Last Name	126
First Name	126
MI	126
Date of Birth / Sex	127
Date of Birth	127
Sex	127
Address	127
Address	127
City	127
State	127
Zip Code	127
Citation and Violations	127
Citation	127
Citation Pending	127
Violation 1	128
Violation 2	128
Driver Actions	128

Click on the page number and the link will take you to the appropriate page.

Driver Distracted By.....	128
Condition at Time of Crash.....	129
Driver Actions at Time of Crash 1.....	130
Driver Actions at Time of Crash 2.....	131
Alcohol.....	132
Alcohol Test.....	132
Result Pending.....	132
BAC Result.....	132
Drugs.....	133
Drug Test.....	133
Drug Test Result.....	133
Occupant Details.....	134
Seat Row.....	134
Seat Position.....	135
Seat Position Other.....	135
Air Bag Deployed.....	136
Ejected.....	137
Restraint System.....	138
Helmet Use.....	139
Injury Degree.....	139
Injury Type.....	140
Injury Area.....	141
Injury Info Source.....	141
Ambulance Code.....	142
Pedestrians/Bicycle Elements.....	143
Name.....	143
Date of Birth / Sex.....	143

Click on the page number and the link will take you to the appropriate page.

Address	144
Citation and Violations.....	144
Alcohol.....	144
Drugs.....	145
Drug Test Result.....	146
Occupant Details	146
Helmet Use (Bicycle).....	146
Injury Degree	147
Injury Type.....	148
Injury Area	149
Injury Info Source	149
Ambulance Code.....	150
Non Motorist Details (Pedestrian/Bicyclists)	150
Condition at Time of Crash.....	150
Location at Time of Crash	151
Action Prior to Crash	154
Action at Time of Crash 1 and 2	155
Pedestrian Maneuvers.....	156
Bicyclists Maneuvers	158
Witness Elements	158
Select Person	158
Name.....	158
Address	158
Commercial Vehicle	159
Carrier Identification Numbers	165
No Carrier Identification Numbers	165
US DOT Number	166

Click on the page number and the link will take you to the appropriate page.

MC/MX Number	166
State Number	167
MCSAP Number	167
Carrier Name and Address	167
Carrier Name	167
Address	171
City	171
State	171
Zip Code	171
Carrier Phone	171
Vehicle Information	172
Motor Carrier Type	172
Cargo body Type	173
Cargo Code	180
Commodity Code	180
Bus Use	182
HAZMAT Class Number	184
HAZMAT 4 digit Number	186
Was Hazardous Material Released	189
Property Damage	189
Damage	189
Damage Description	189
Property Owner Type	190
Property Owner	190
Address	190
Crash Diagram	191
Edit Diagram	191

Click on the page number and the link will take you to the appropriate page.

New Drawing (Easy Street Draw) 191

Diagram Measurements..... 193

Scene Measurements 194

 What to Measure 194

 Diagramming Method 194

 Special Instructions 197

Fatal Crash Investigation 200

 Equipment..... 200

 Emergency Equipment 200

 Forms 200

 Measuring 200

 Photography 201

 Planning At-Scene Investigation 202

 Principles and Problems 202

 Considerations in Planning 204

 Information from People..... 205

 Informants..... 206

 Levels of Inquiry..... 206

 Place of Inquiry..... 207

 Finding Informants at the Scene 207

 Finding Driver at the Scene 207

 Finding Witness and Passengers 208

 Initial Questioning at the Scene 209

 Condition before the Crash..... 210

 Driving Impairment..... 211

 Information from the Vehicles 212

Click on the page number and the link will take you to the appropriate page.

Identification 212

Description..... 212

Damage 213

Technical Post Crash Inspection 214

Information from the Roads..... 214

 The Roadway in General 214

 Evidence on the Roadway as a result of the Crash Events 216

 First Contact Point or Area of Impact..... 220

 Off the ground..... 222

 Final Positions 223

Photographing Crash Scenes 223

 General At-Scene Photos 224

 Road and Roadway Evidence Photos 225

 Vehicle Damage Photos 226

Evidence Collection 227

 Photo/Video Footage..... 227

 Blood Samples for All Operators..... 227

 Vehicle Impound/Inventory 228

 Additional Resources..... 228

 Notifications 229

Investigating Vehicle/Train collisions 231

 Tips for Law Enforcement Officers..... 231

 General Information..... 232

Click on the page number and the link will take you to the appropriate page.

Report Writing 233

 Fatal Investigative Report 233

File 14-1 First Report of Fatal Teletype..... 236

Sources 238

Click on the form field link to go to the appropriate description page

Quick Reference

The following crash data element numbers coincide with the 13:20 Quick Reference where the data elements are identified by number on the form.

Location Page

STATE OF MAINE CRASH REPORT						FIRST PAGE			
F I R S T	Reporting Agency	1	Report Number	2	Crash Date	Crash Time	At Scene Date	At Scene Time	
	City or Town	Street or Highway			Nearest Intersecting Street		5	<input type="checkbox"/> Off Road	3
	Direction FROM Nearest Intersection to Crash Site <input type="checkbox"/> At Intersection <input type="checkbox"/> North <input type="checkbox"/> South <input type="checkbox"/> East <input type="checkbox"/> West			Dist. 6	from Nearest Inter. <input type="checkbox"/> Feet <input type="checkbox"/> Miles	Latitude	7	Longitude	
	Node 1	Node 2	Measurement Node	Distance to Scene Miles Tenths	Posted Speed Limit Miles Per Hour	<input type="checkbox"/> Unknown <input type="checkbox"/> N/A	<input type="checkbox"/> Not Posted 25 <input type="checkbox"/> Not Posted 45	8	
	(F1) Type of Crash			(F2) Type of Location		9		4	
	(F3) Weather Condition			(F4) Light Condition		10		11	
	(F5) Road Grade			(F6) Road Surface Condition		12		13	
	(F7) Traffic Control Device			Traffic Control Device Operational (pre-crash)? <input type="checkbox"/> Yes <input type="checkbox"/> No <input type="checkbox"/> Unk		14		15	
	(F8) Location of First Harmful Event			Total Damage over Threshold? <input type="checkbox"/> Yes <input type="checkbox"/> No		16		17	
	(F9) Contributing Circumstances - Environment 1			(F9) Contributing Circumstances - Environment 2		18			
	(F10) Contributing Circumstances - Road 1			(F10) Contributing Circumstances - Road 2		19			
	20 In or Near a Construction, Maintenance, or Utility Work Zone? <input type="checkbox"/> Yes <input type="checkbox"/> No <input type="checkbox"/> Unk			Work Zone Workers Present? <input type="checkbox"/> Yes <input type="checkbox"/> No <input type="checkbox"/> Unk		21			
	(F11) Location of the Crash related to Work Zone			(F12) Type of Work Zone		22		23	
	24 Law Enforcement Present at Work Zone? <input type="checkbox"/> Officer Present <input type="checkbox"/> Law Enforcement Vehicle Only <input type="checkbox"/> No			School Bus Related? <input type="checkbox"/> Yes, Directly Involved <input type="checkbox"/> Yes, Indirectly Involved <input type="checkbox"/> No		25			
	NARRATIVE				CRASH DIAGRAM				
86				85					
Witness Last Name		69	First	MI	Address	City	State	Zip	
Witness Last Name			First	MI	Address	City	State	Zip	
Non Vehicle Property Damage Description			83	84	<input type="checkbox"/> State <input type="checkbox"/> City or Town <input type="checkbox"/> Utilities <input type="checkbox"/> Private				
Property Owner Name			Address		City	State	Zip		
Non Vehicle Property Damage Description					<input type="checkbox"/> State <input type="checkbox"/> City or Town <input type="checkbox"/> Utilities <input type="checkbox"/> Private				
Property Owner Name			Address		City	State	Zip		
Reporting Officer		Badge#	Report Date	26	Approved By	27	Approved Date		

Click on the form field link to go to the appropriate description page

Unit Page

Report Number		STATE OF MAINE CRASH REPORT										UNIT PAGE						
UNIT	Unit ID	<input type="checkbox"/> Hit Run?	VIN	29	License Plate	State	(U1) Unit Type	28										
	<input type="checkbox"/> No Insurance	NAIC	30	Insurance Company Name			Insurance Policy Number											
	(U2) Vehicle Make				Vehicle Year		(U3) Vehicle Color											
	(U4) Vehicle Configuration				33		GVWR or GCWR					34						
							<input type="checkbox"/> < 10,000 lbs. <input type="checkbox"/> 10,001 - 26,000 lbs. <input type="checkbox"/> > than 26,000 lbs.											
DRIVER	35 Vehicle Has 9 or More Seats ?		<input type="checkbox"/> Yes <input type="checkbox"/> No		HAZMAT Placarded ?		<input type="checkbox"/> Yes <input type="checkbox"/> No		32		Vehicle Travel Direction		40					
											<input type="checkbox"/> Northbound <input type="checkbox"/> Southbound <input type="checkbox"/> Eastbound <input type="checkbox"/> Westbound <input type="checkbox"/> Not on Roadway <input type="checkbox"/> Unknown							
	(U5) Special Function Vehicle		36		31		<input type="checkbox"/> Exempt Vehicle		Emergency Vehicle Responding to Scene ?				37					
	38 Extent of Damage		<input type="checkbox"/> No Damage Observed		<input type="checkbox"/> Minor Damage		<input type="checkbox"/> Functional Damage		<input type="checkbox"/> Towed Due to Disabling Damage									
OWNER	(U6) Most Damaged Area				39		(U7) Most Harmful Event				41							
	(U8) Pre Crash Actions				42		(U9) Contributing Circumstances - Vehicle				43							
	(U10) Sequence of Events 1				44		(U10) Sequence of Events 2											
	(U10) Sequence of Events 3						(U10) Sequence of Events 4											
VEHICLE	<input type="checkbox"/> Driver		<input type="checkbox"/> Bicycle		<input type="checkbox"/> Pedestrian		License Number		<input type="checkbox"/> Active <input type="checkbox"/> No License <input type="checkbox"/> Permit		State		License Class	46	lements	Restrictions		
	DRIVER Last Name				First Name		MI		DRIVER Address				47	City	State	Zip		
	Citation Number				Pending <input type="checkbox"/>		48		Violation 1				Violation 2					
	OWNER Last Name (skip if same as Driver)				First Name		MI		OWNER Address				City	State	Zip			
CRASH	(D1) Driver Distracted By				49		(D2) Condition at Time of Crash				50							
	(D3) Driver Actions at Time of Crash 1				51		(D3) Driver Actions at Time of Crash 2											
	52 Alcohol Test		<input type="checkbox"/> Test Not Given		<input type="checkbox"/> Test Refused		<input type="checkbox"/> Blood		<input type="checkbox"/> Alcohol Test Result Pending		Alcohol BAC Result		53					
			<input type="checkbox"/> Breath		<input type="checkbox"/> Urine		<input type="checkbox"/> Other											
PERSON	54 Drug Test		<input type="checkbox"/> Test Not Given		<input type="checkbox"/> Test Refused		<input type="checkbox"/> Blood		Drug Test Result				<input type="checkbox"/> Positive <input type="checkbox"/> Negative <input type="checkbox"/> Pending		55			
			<input type="checkbox"/> Urine		<input type="checkbox"/> Other													
	(D4) Non Motorist Location at Time of Crash				64		(D5) Non Motorist Action Prior to Crash				65							
	(D6) Non Motorist Action at Time of Crash 1				66		(D6) Non Motorist Action at Time of Crash 2											
	(D7) Pedestrian Maneuvers				67		(D8) Bicyclist Maneuvers				68							
OCCUPANTS	PERSON TYPE 1-Driver, 2-Passenger, 3-Pedestrian, 6-Driver/Owner, 7-Bicycle, 8-Passenger/Owner, 24-Last Known Operator 25-Last Known Operator/Owner																	
	SEAT ROW		SEAT POSITION		SEAT POSITION OTHER		AIRBAG DEPLOYED		RESTRAINT SYSTEM		INJURY TYPE		INJURY AREA		INJURY DEGREE			
	1-Front Row		1-Left (driver)		1-Sleeper Section of Cab (truck)		1-Not Deployed		1-Not Applicable		1-Amputation		1-Face		1-Fatal			
	2-Second Row		2-Middle		2-Other Enclosed Cargo Area		2-Deployed		2-None Used - Motor Vehicle Occupant		2-Bleeding		2-Head		2-Internal			
	3-Third Row		3-Right		3-Unenclosed Cargo Area		3-Deployed		3-Shoulder and Lap Belt Used		3-Other		3-Other		3-Non-Fatal			
4-Fourth Row		4-Other		4-Trailing Unit		4-Deployed		4-Shoulder Only Used		4-Other		4-Other		4-Partial				
5-Other Row		5-Unknown		5-Riding on Motor Vehicle Ext (non-trailing unit)		5-Deployed		5-Lap Only Used		5-Other		5-Other		5-No Injury				
6-Unknown		6-Unknown		6-Unknown		6-Deployed		6-Other		6-Shock		6-Leg(s)		6-Other				
EJECTED		HELMET USE		7-Deployment - Curtain		7-Deployment - Other		7-Child Restraint - Forward Facing		7-Dizziness		7-Chest Stomach		7-Other				
1-Not Ejected		1-DOT		2-Other motorcycle Helmet		8-Deployment - Other		8-Child Restraint - Rear Facing		8-Abrasion/Bruses		8-Internal		8-Other				
2-Ejected Partially		2-Other		3-Other		9-Child Restraint - Used Incorrectly		9-Complaint of Pain		9-Entire Body		9-Other		9-Other				
3-Ejected Totally		3-No Hel		59		10-Booster Seat		10-Other		10-Other		10-Other		10-Other				
AMB CODES - see code sheet																		
Person Type	Include Driver, Passengers, Bicyclist, and Pedestrians				Sex (M,F,U)	DOB	Seat Pos Row	Seat Pos	Seat Pos Other	Air Bag Deployed	Ejected	Restraint System	Helmet Use	Injury Degree	Injury Type	Injury Area	Inj Info Source	Amb Code
	Last Name, First Name, MI																	

Click on the form field link to go to the appropriate description page

Commercial Page

STATE OF MAINE CRASH REPORT

Report Number		Commercial Vehicle Supplemental			No Carrier Identification Numbers <input type="checkbox"/>
Unit ID	USDOT Number 70	MCMX Number 71	State Number 72	MCSAP Number 73	
75	<input type="checkbox"/> Interstate Carrier <input type="checkbox"/> Intrastate Carrier <input type="checkbox"/> Not in Commerce-Government <input type="checkbox"/> Not in Commerce-Other Trucks (Over 10,000 lbs. GVWR/GCWR)				
Carrier Name 74				Carrier Phone	
Address		City	State	Zip	
<input type="checkbox"/> Oversize Permit Weight		<input type="checkbox"/> Oversize Permit Length	<input type="checkbox"/> Oversize Permit Height	<input type="checkbox"/> Oversize Permit Width	
<input type="checkbox"/> Cargo Body Type (enter one 76 from below)		<input type="checkbox"/> Unloaded	<input type="checkbox"/> Partially Loaded	<input type="checkbox"/> Loaded 77	
1 Bus (9-15 Seats, Including Driver) 		6 Dump 		11 Pole 	
2 Bus (16 or More Seats, Including Driver) 		7 Concrete Mixer 		12 Log 	
3 Van/Enclosed Box 		8 Auto Transporter 		13 Intermodal Chassis 	
4 Cargo Tank 		9 Garbage/Refuse 		14 Vehicle Towing Motor Vehicle 	
5 Flat Bed 		10 Grain, Chips, Gravel 		15 No Cargo Body 	
98 Other Cargo Body (not listed above)					
<input type="checkbox"/> Commodity Code (enter one code from below)					
78 A General Freight B Household Goods C Metal Sheets, Coils, Rolls D Motor Vehicles E DriveAway / TowAway F Forest Products G Building Products H Mobile Homes I Machinery, Large Objects		J Fresh Produce K Liquids / Gases in Cargo Tank L Intermodal M Passengers N Oil Field Equipment O Livestock P Grain, Feed, Hay Q Coal / Coke R Meat		S Garbage, Refuse, Trash T U.S. Mail U Chemicals V Commodities, Dry Bulk W Refrigerated Foods X Beverage Y Paper Products Z Other	
<input type="checkbox"/> Bus Use (enter one code from below)					
0 Not a Bus		2 Transit 79		4 Charter	
1 School (Public or Private)		3 Intercity		5 Other	
<input type="checkbox"/> HAZMAT Class Number (enter one code from below)					
80 1 Explosives 2 Gases - Compressed, Dissolved or Refrigerated 3 Flammable Liquids 4 Flammable Solids-Combustible, Water Reactive 5 Oxidizing Substances-Organic Peroxides		6 Poisonous (Toxic) and Infectious Substances 7 Radioactive Material 8 Corrosives 9 Miscellaneous Dangerous Goods, or Blank			
<input type="checkbox"/> 81 HAZMAT 4 Digit Number		Was HAZMAT released from THIS vehicle's cargo? <input type="checkbox"/> YES <input type="checkbox"/> NO <input type="checkbox"/> UNKNOWN			<input type="checkbox"/> 82

Coding Guide 1

F

FIRST PAGE CODING GUIDE

(F1) TYPE OF CRASH		(F2) TYPE OF LOCATION	
1 Object in Road	11 Jackknife	1 Straight Road	11 Open Field
2 Rear End / Sideswipe	12 Rollover	2 Curved Road	12 Gravel Pit
3 Head-on / Sideswipe	13 Fire	3 Three Leg Intersection	13 Woods
4 Intersection Movement	14 Submersion	4 Four Leg Intersection	14 Lake/Pond
5 Pedestrians	15 Thrown or Falling Object	5 Five or More Leg Intersection	15 River/Stream
6 Train	16 Bear	6 Driveways	16 Ocean
7 Went Off Road	17 Deer	7 Bridges	17 Parking Lot
8 All Other Animal	18 Moose	8 Interchanges	18 Private Way
9 Bicycle	19 Turkey	9 Other	19 Cross Over
10 Other		10 Trail	20 Railroad Crossing
			21 Traffic Circle/Roundabout
(F3) WEATHER CONDITION		(F4) LIGHT CONDITION	
1 Clear	7 Blowing Snow	1 Daylight	7 Unknown
2 Cloudy	8 Severe Crosswinds	2 Dawn	
3 Fog, Smog, Smoke	9 Blowing Sand, Soil, Dirt	3 Dusk	
4 Rain	10 Other	4 Dark - Lighted	
5 Sleet, Hail (Freezing Rain or Drizzle)		5 Dark - Not Lighted	
6 Snow		6 Dark - Unknown Lighting	
(F5) ROAD GRADE		(F6) ROAD SURFACE CONDITION	
1 Level		1 Dry	7 Sand
2 On Grade		2 Wet	8 Mud, Dirt, Gravel
3 Top of Hill		3 Snow	9 Oil
4 Bottom of Hill		4 Slush	10 Other
5 Other		5 Ice/Frost	11 Unknown
		6 Water (Standing, Moving)	
(F7) TRAFFIC CONTROL DEVICE			
1 Traffic Signals (Stop and Go)	6 Yield Sign	11 R.R. Crossing Device	
2 Traffic Signals (Flashing)	7 Curve Warning Sign	12 No Passing Zone	
3 Advisory/Warning Sign	8 Officer, Flagman, School Patrol	13 None	
4 Stop Signs - All Approaches	9 School Bus Stop Arm	14 Other	
5 Stop Signs - Other	10 School Zone Sign		
(F8) LOCATION OF FIRST HARMFUL EVENT			
1 On Roadway	4 Roadside	7 In Parking Lane or Zone (Not Parking Lot)	
2 Shoulder	5 Gore	8 Parking Lot / Off Roadway / Location Unknown	
3 Median	6 Separator	9 Outside Right-of-Way(trafficway)	
(F9) CONTRIBUTING CIRCUMSTANCES - ENVIRONMENT			
1 None	3 Physical Obstructions	5 Animal(s) in Roadway	
2 Weather	4 Glare	6 Other	
(F10) CONTRIBUTING CIRCUMSTANCES - ROAD			
1 None		7 Obstruction in Roadway	
2 Road Surface Condition (Wet, Icy, Snow, Slush, etc.)		8 Traffic Control Device Inoperative, Missing or Obscured	
3 Debris		9 Shoulders (None, Low, Soft, High)	
4 Rut, Holes, Bumps		10 Non-Highway Work	
5 Work Zones (Construction / Maintenance / Utility)		11 Other	
6 Worn, Travel-Polished Surface			
(F11) LOCATION OF CRASH RELATED TO WORK ZONE		(F12) TYPE OF WORK ZONE	
1 Before the First Work Zone Warning Sign		1 Lane Closure	
2 Advance Warning Area		2 Lane Shift/Crossover	
3 Transition Area		3 Work on Shoulder or Median	
4 Activity Area		4 Intermittent or Moving Work	
5 Termination Area		5 Other	

Maine Department of Public Safety

CG-1

Form 13:20A Revised January 2010

Coding Guide 2

U

UNITS CODING GUIDE

(U2) VEHICLE MAKE	(U1) UNIT TYPE	(U3) VEHICLE COLOR	(U4) VEHICLE CONFIGURATION (see vehicle configuration diagram - V)	(U5) SPECIAL FUNCTION VEHICLE	(U6) MOST DAMAGED AREA (see vehicle damage area diagram - V)	(U7) MOST HARMFUL EVENT	(U8) PRE CRASH ACTIONS	(U9) CONTRIBUTING CIRCUMSTANCES - VEHICLE	(U10) SEQUENCE OF EVENTS
1 ACURA	1 Passenger Car	1 Black	1 Passenger Car (only if vehicle has Hazardous Materials Placard)	1 No Special Function	1 Front Passenger Corner	1 Overturn / Rollover	1 Following roadway	1 None	1 Overturn / Rollover
2 ALFA ROMEO	2 (Sport) Utility Vehicle	2 Beige	2 Light Truck (only if vehicle has Hazardous Materials Placard)	2 Taxi	2 Front Passenger Quarter Panel	2 Fire / Explosion	2 Wrong way into opposing traffic	2 Brakes	2 Fire / Explosion
3 AMERICAN MOTORS	3 Passenger Van	3 Burgundy	3 Bus (seats for 9-15 people, including driver)	3 Vehicle Used as School Bus	3 Center Passenger Side	3 Immersion	3 Right turn on red	3 Exhaust System	3 Immersion
4 ASUNA	4 Cargo Van (10K lbs or Less)	4 Blue	4 Bus (seats for 16 people or more, including driver)	4 Vehicle Used as School Bus	4 Rear Passenger Quarter Panel	4 Jackknife	4 Left turn on red	4 Body, Doors	4 Jackknife
5 AUDI	5 Pickup	5 Green	5 Single-Unit Truck (2 axles, 6 tires)	5 Police	5 Rear Passenger Corner	5 Cargo / Equipment Loss Or Shift	5 Making right turn	5 Steering	5 Cargo / Equipment Loss Or Shift
6 AUSTIN	6 Motor Home	6 Gold	6 Single-Unit Truck (3 axles)	6 Police	6 Rear	6 Fell / Jumped from Motor Vehicle	6 Making left turn	6 Power Train	6 Equipment Failure (blown tire, brake failure, etc.)
7 BMW	7 School Bus	7 Brown	7 Single-Unit Truck (4 axles with rear tri-axle)	7 Vehicle Used as School Bus	6 Rear	7 Thrown or Falling Object	7 Making U turn	7 Suspension	7 Separation of Units
8 BUICK	8 Transit Bus	8 Grey, Silver	8 Single-Unit Truck (5 or more axles)	8 Police	6 Rear	8 Other Non-Collision	8 Starting from parked	8 Tires	8 Went Off Roadway Right
9 CADILLAC	9 Motor Coach	9 Purple, Orange, Other	9 Tractor/Trailer(s) [Single-Unit Truck with Trailer(s)]	8 Fire Truck	6 Rear	9 Pedestrian	9 Starting in traffic	9 Wheels	9 Went Off Roadway Left
10 CAPRI		10 Red	10 Truck Tractor (without trailer, bobtail or saddle mount)		6 Rear	10 Pedalcycle	10 Slowing in traffic	10 Lights (head, signal, tail, brake)	10 Cross Median
11 CHEVROLET		11 Maroon	11 Tractor/Semi-Trailer (one trailer - 5 axles)		6 Rear	11 Railway Vehicle - Train, Engine	11 Stopped in traffic		11 Cross Centerline
12 CHRYSLER		12 Cream	12 Tractor/Semi-Trailer (one trailer - 6 axles)		6 Rear	12 Animal	12 Entering parked position		12 Downhill Runaway
13 DAEWOO		13 White	13 Tractor/Semi-Trailer (one trailer - All other axle configurations)		6 Rear	13 Motor Vehicle in Transport	13 Parked Legally		13 Fell/Jumped From Motor Vehicle
14 DAIHATSU		14 Yellow	14 Tractor/Doubles (two trailers)		6 Rear	14 Parked Motor Vehicle	14 Parked Illegally		14 Reentering Roadway
15 DODGE			15 Tractor/Triples (three trailers)		6 Rear	14 Parked Motor Vehicle	15 Avoiding Vehicle Object, Pedestrian, Animal in Road		15 Thrown or Falling Object
16 DODGE			99 Other Truck Greater Than 10,000 lbs. (not listed above)		6 Rear	14 Parked Motor Vehicle	16 Skidding		16 Other Non-Collision
17 EAGLE					6 Rear	14 Parked Motor Vehicle			17 Pedestrian
18 FIAT					6 Rear	14 Parked Motor Vehicle			
19 FORD					6 Rear	14 Parked Motor Vehicle			
20 FREIGHTLINER					6 Rear	14 Parked Motor Vehicle			
21 FWD					6 Rear	14 Parked Motor Vehicle			
22 GEO					6 Rear	14 Parked Motor Vehicle			
23 GM					6 Rear	14 Parked Motor Vehicle			
24 GMC					6 Rear	14 Parked Motor Vehicle			
25 HARLEY DAVIDSON					6 Rear	14 Parked Motor Vehicle			
26 HINO					6 Rear	14 Parked Motor Vehicle			
27 HONDA					6 Rear	14 Parked Motor Vehicle			
28 HYUNDAI					6 Rear	14 Parked Motor Vehicle			
29 INFINITI					6 Rear	14 Parked Motor Vehicle			
30 INTERNATIONAL					6 Rear	14 Parked Motor Vehicle			
31 ISUZU					6 Rear	14 Parked Motor Vehicle			
32 IVECO					6 Rear	14 Parked Motor Vehicle			
33 JAGUAR					6 Rear	14 Parked Motor Vehicle			
34 JEEP					6 Rear	14 Parked Motor Vehicle			
35 JENSEN					6 Rear	14 Parked Motor Vehicle			
36 KAWASAKI					6 Rear	14 Parked Motor Vehicle			
37 KENWORTH					6 Rear	14 Parked Motor Vehicle			
38 KIA					6 Rear	14 Parked Motor Vehicle			
39 LADA					6 Rear	14 Parked Motor Vehicle			
40 LANCIA					6 Rear	14 Parked Motor Vehicle			
41 LAND ROVER					6 Rear	14 Parked Motor Vehicle			
42 LEXUS					6 Rear	14 Parked Motor Vehicle			
43 LINCOLN					6 Rear	14 Parked Motor Vehicle			
44 MACK					6 Rear	14 Parked Motor Vehicle			
45 MAZDA					6 Rear	14 Parked Motor Vehicle			
46 MERCEDES BENZ					6 Rear	14 Parked Motor Vehicle			
47 MERCURY					6 Rear	14 Parked Motor Vehicle			
48 MERKUR					6 Rear	14 Parked Motor Vehicle			
49 MG					6 Rear	14 Parked Motor Vehicle			
50 MITSUBISHI					6 Rear	14 Parked Motor Vehicle			
51 NISSAN					6 Rear	14 Parked Motor Vehicle			
52 OLDSMOBILE					6 Rear	14 Parked Motor Vehicle			
53 OPEL					6 Rear	14 Parked Motor Vehicle			
54 OSHKOSH					6 Rear	14 Parked Motor Vehicle			
55 PASSPORT					6 Rear	14 Parked Motor Vehicle			
56 PETERBILT					6 Rear	14 Parked Motor Vehicle			
57 PEUGEOT					6 Rear	14 Parked Motor Vehicle			
58 PLYMOUTH					6 Rear	14 Parked Motor Vehicle			
59 PONTIAC					6 Rear	14 Parked Motor Vehicle			
60 PORSCHE					6 Rear	14 Parked Motor Vehicle			
61 RENAULT					6 Rear	14 Parked Motor Vehicle			
62 SAAB					6 Rear	14 Parked Motor Vehicle			
63 SATURN					6 Rear	14 Parked Motor Vehicle			
64 SSI					6 Rear	14 Parked Motor Vehicle			
65 STERLING					6 Rear	14 Parked Motor Vehicle			
66 SUBARU					6 Rear	14 Parked Motor Vehicle			
67 SUZUKI					6 Rear	14 Parked Motor Vehicle			
68 TOYOTA					6 Rear	14 Parked Motor Vehicle			
69 TRIUMPH					6 Rear	14 Parked Motor Vehicle			
70 VOLKSWAGEN					6 Rear	14 Parked Motor Vehicle			
71 VOLVO					6 Rear	14 Parked Motor Vehicle			
72 WHITE					6 Rear	14 Parked Motor Vehicle			
73 WHITEGMC					6 Rear	14 Parked Motor Vehicle			
74 WINNEBAGO					6 Rear	14 Parked Motor Vehicle			
75 YAMAHA					6 Rear	14 Parked Motor Vehicle			
76 YUGO					6 Rear	14 Parked Motor Vehicle			
99 OTHER					6 Rear	14 Parked Motor Vehicle			

Maine Department of Public Safety

CG-2

Form 13:20A Revised January 2010

Coding Guide 3

D

DRIVER CODING GUIDE

(D1) DRIVER DISTRACTED		
1 Not Distracted		6 Unknown
2 Electronic Communication Devices (Cell Phone, Pager, etc.)		
3 Other Electronic Devices (Navigation Device, Palm Pilot, Entertainment Device, etc.)		
4 Other Inside the Vehicle (Eating, Reading, Grooming, Smoking, Passengers, etc.)		
5 External Distraction (outside the vehicle)		
(D2) CONDITION AT TIME OF CRASH		
1 Apparently Normal	5 Asleep or Fatigued	
2 Physically Impaired or Handicapped	6 Under the Influence of Medications/Drugs/Alcohol	
3 Emotional (Depressed, Angry, Disturbed, etc.)	7 Other	
4 Ill (Sick)		
(D3) DRIVER ACTIONS AT TIME OF CRASH		
1 No Contributing Action	12 Improper Passing	
2 Ran Off Roadway	13 Wrong Way	
3 Failed to Yield Right-of-Way	14 Followed Too Closely	
4 Ran Red Light	15 Failed to Keep in Proper Lane	
5 Ran Stop Sign	16 Operated Motor Vehicle in Erratic, Reckless, Careless, Negligent or Aggressive Manner	
6 Disregarded Other Traffic Sign	17 Swerved or Avoided Due to Wind, Slippery Surface, Motor Vehicle, Object, Non-Motorist in Roadway	
7 Disregarded Other Road Markings	18 Over-Correcting/Over-Steering	
8 Exceeded Posted Speed Limit	19 Other Contributing Action	
9 Drove Too Fast For Conditions	20 Unknown	
10 Improper Turn		
11 Improper Backing		
(D4) NON-MOTORIST LOCATION AT TIME OF CRASH		
1 Intersection – Marked Crosswalk	6 Bicycle Lane	11 Shared-Use Path or Trail
2 Intersection – Unmarked Crosswalk	7 Shoulder/Roadside	12 Non-Trafficway Area
3 Intersection – Other	8 Sidewalk	13 Other
4 Midblock – Marked Crosswalk	9 Median/Crossing Island	14 Unknown
5 Travel Lane – Other Location	10 Driveway Access	
(D5) NON-MOTORIST ACTION PRIOR TO CRASH		
1 Crossing Roadway	8 Getting On/Off School Bus	
2 Waiting to Cross Roadway	9 Going to or from School (K-12)	
3 Walking/Cycling Along Roadway with Traffic (In or Adjacent to Travel)	10 Responder Working in Trafficway (Incident Response)	
4 Walking/Cycling Along Roadway Against Traffic (In or Adjacent to Travel)	11 Other	
5 Walking/Cycling on Sidewalk	12 None	
6 In Roadway – Other (Working, Playing, Etc.)	13 Unknown	
7 Adjacent to Roadway (e.g., Shoulder, Median)		
(D6) NON-MOTORIST ACTION AT TIME OF CRASH		
1 No Improper Action	8 Inattentive (Talking, Eating, Etc.)	
2 Dart/Dash	9 Not Visible (Dark Clothing, No Lighting, Etc.)	
3 Failure to Yield Right-Of-Way	10 Improper Turn/Merge	
4 Failure to Obey Traffic Signs, Signals, or Officer	11 Improper Passing	
5 In Roadway Improperly (Standing, Lying, Working, Playing)	12 Wrong-Way Riding or Walking	
6 Disabled Vehicle Related (Working on, Pushing, Leaving/Approaching)	13 Other	
7 Entering/Exiting Parked/Standing Vehicle	14 Unknown	
(D7) PEDESTRIAN MANEUVERS		
1 Crossing with Signal	7 Standing in road	13 Playing in road
2 Crossing against Signal	8 Emerging from behind parked car	14 Not in road
3 Crossing Marked Crosswalk no signal	9 Child getting on/off School Bus	15 Following Trail
4 Crossing No Signal or Crosswalk	10 Getting on/off Vehicle	16 Walking on Sidewalk
5 Walking in road with traffic	11 Pushing or working on vehicle	17 Walking Adjacent to Roadway
6 Walking in road against traffic	12 Working in road	18 Walking to/from School
		19 Other Pedestrian Action
(D8) BICYCLIST MANEUVERS		
1 Bicycle - Riding with traffic	4 Bicycle - Making Left turn	7 Bicycle - Slowing, Stopping, Starting in Road
2 Bicycle - Riding against Traffic	5 Bicycle - Making U turn	8 Bicycle - Other Bicyclist Action
3 Bicycle - Making Right turn	6 Bicycle - Riding Across Road	99 Unknown

Maine Department of Public Safety

CG-3

Form 13:20A Revised January 2010

Coding Guide 4



VEHICLE CONFIGURATION AND DAMAGE

VEHICLE CONFIGURATION	
<p>Bus (9-15 Seats, Including Driver)</p>	<p>Truck/Trailer (Single-Unit Truck Pulling a Trailer)</p>
<p>Bus (16 or More Seats, Including Driver)</p>	<p>Truck Tractor (Bobtail)</p>
<p>Single-Unit (2 Axles, 6 Tires)</p>	<p>Tractor/Semi Trailer (One Trailer)</p>
<p>Single-Unit (3 or More Axles)</p>	<p>Truck Tractor/Double (Two Trailers)</p>
	<p>Truck Tractor/Triple (Three Trailers)</p>

VEHICLE DAMAGE AREA	
<p>Passenger Car</p>	<p>Motorcycle</p>
<p>Bus</p>	<p>Tractor Trailer</p>
	<p>Passenger Car with Trailer</p>

Maine Department of Public Safety

CG-4

Form 13:20A Revised January 2010

Coding Guide 5

A

AMBULANCE CODES

1 Not Transported	246 East Grand Ambulance Service	493 NRH Tri-State Medical	715 Upper Kennebec Valley Amb	909 Gtenee Fire Dept Rescue
2 Act Ambulance	247 McGovern East Bay - Ferry	495 Ogunquit Rescue	720 Van Buren Ambulance Service	910 Industry Fire Department
3 Acton Ambulance Assn	248 McGovern East Bay - Eastport	500 Old Orchard Beach EMS	725 WCEMSA dba Downeast EMS Calais	911 Holden Rescue
5 Alfred Rescue Squad	250 East Millisocket Amb	505 Old Town Fire Dept	726 WCEMSA dba Downeast EMS Lubec	913 Hollis Rescue
16 Ambulance Serv Inc Allagash	254 Eastport Ambulance Inc.	508 Orono Fire-Rescue	727 WCEMSA dba Downeast EMS Eastpt	914 Jefferson Fire and Rescue
17 Ambulance Serv Inc Ft Kent	260 Falmouth EMS	510 Orr/Bailey Island Rescue	728 WCEMSA dba Downeast EMS Dufin	915 Kennebunk First Responders
18 Ambulance Serv Inc Eagle Lake	270 Freeport Rescue	513 Orrington Vol Amb Ser	730 Waidoboro Emergency Med Svc	916 Lebanon Rescue Squad
19 Ambulance Serv Inc St Agatha	275 Friendship Amb Serv	515 Oxford Fire Dept/Rescue/Oxford	733 Warren Rescue	920 Lovant Vol Rescue Squad
20 AMPS Ambulance	276 Frisbie Memorial Hospital-EMS	520 Pace Paramedic Service	735 Waterboro Fire Dept Rescue	922 Litchfield First Responders
25 Anson Madison Amb Svc	280 Fryeburg Rescue	525 Patten Amb Service	741 Wells Emergency Med Svc	924 Matineas Island Rescue
30 Arundel Fire Rescue	282 Gardiner Amb Serv	527 Peaks Island Ambulance	745 Westbrook EMS	925 Matawamkeag Rescue
38 Auburn Fire Department	285 Georgetown Ambulance	530 Peninsula Amb Corps	760 Windham Rescue	929 Mariaville Vol Fire Dept. Inc
40 Ashland Ambulance Service	290 Georgia-Pacific Ambulance	534 Penobscot Valley Hosp/Lincoln	765 Windsor Volunteer Amb Corp	930 Mechanic Falls Rescue
41 Augusta Fire Department	295 G and H Ambulance Service	535 Penobscot Valley Hosp/Howland	769 Winthrop Amb Service	932 Monson Fire Dept First Respond
45 Baileyville Vol Amb	297 Goodwins Mills Rescue	537 Petit Manan Amb/Millbridge	770 Winterport Vol Amb Sv	933 Mt Vernon Rescue
47 Bagaduce Amb Corps	300 Gorham Fire Department	540 Phippsburg Vol Amb Sv	771 Wiscasset Amb Service	937 New Gloucester Rescue
50 Bangor Fire Department	303 Grand Lake Stream Rescue	542 McGovern/Pleasant River Amb Sv	775 Yarmouth Rescue Unit	938 New Sharon Fire Department
55 Bar Harbor Fire Dept	305 Gray Fire/Rescue	543 Poland Rescue	780 York Vol Ambulance Assoc	939 Newport Fire Department
60 Baxter Fire and Rescue	320 Hampden Ambulance Service	544 Pleasant River Amb Service Inc	801 Delta Ambulance Corp.	940 Oakland Fire/Rescue
70 Bath Fire Department	324 Harmony Regional Amb Service	546 MEDCU	802 Crown Air Ambulance	941 Nobleboro First Responders
72 Bath Iron Works Rescue	325 Harswell Neck Fire and Rescue	560 Rangeley Region Amb Service	803 Caribou Fire/Air Ambulance Svc	944 Osborn Municipal Vol Fire Dept
75 Beals Ambulance Service	330 Hartland and St Albans Ambulance	565 Raymond Rescue	805 JetMed	945 Northport First Responders
80 Beech Ridge Speedway Amb	350 Hermon Volunteer Rescue	580 Rockland EMS	806 Capital Ambulance Service	948 Palermo Rescue
85 Belfast Amb and Rescue Sv	360 Houlton Amb Service	595 Saco Fire Department	807 Life Flight of Maine-Bangor	952 Phillips Fire Rescue
88 AMR - Scarborough	365 Indian Township Fire and Rescue	600 Sacoopie Rescue Inc.	808 LifeFlight of Maine-Lewiston	955 Plymouth Fire Department
90 AMR - Eliot	367 Island Community Ambulance	605 St George Vol Firefighter Assn	809 North East Mobile Health Servi	956 Pownal Fire Dept First Respond
91 AMR - Somersworth	370 Islesboro Ambulance Service	610 Sanford Fire Dept Amb Svc	840 Acadia National Park	960 Readfield Rescue
92 Bethel Ambulance Serv	378 Jackman Area Vol Ambulance	615 Scarborough Rescue Unit	845 Albion FD Rescue	964 Waltham Municipal Vol Fire Dep
100 Biddeford Ambulance Serv	380 Arthur Jewell Health Center	616 Scarborough Downs EMS	847 Alexander VFD First Resp. Unit	966 SMTIC First Response
104 Boothbay Region Ambulance	385 Moosebec Ambulance	618 Seacoast Ambulance	848 Aina Rescue Unit	968 Rumford Fire Department
110 Brunswick Fire Department EMS	388 Island Falls Amb Serv	620 Seaport Ambulance Service	850 Andover Fire Dept	969 Rockwood Fire/EMS
113 Buckfield Ambulance Serv	390 Kennebec Fire Rescue	625 Sebago Volunteer EMS	853 Arundel First Responders	971 Rome Rescue Squad
115 Bucksport Ambulance Serv	392 Kennebunkport EMS	630 Sebasticook Valley Hosp Amb	854 Aurora Volunteer Fire Dept.	973 ME State Police Medical Unit
119 Calais Fire Department	400 Kimball Ambulance Serv	635 Shapleigh Rescue Squad	856 Belmont Vol. Fire and Rescue	974 Sebec Volunteer Fire Department
120 Camden First Aid Association	415 Liberty Vol Amb Serv	640 Sipwvik Ambulance Corps	857 Belgrade Rescue	975 Sidney Rescue
130 Cape Elizabeth Rescue	416 LifeStar	645 Rodington Fairview EMS	858 Bowdoin First Responders	976 Sweden First Responders
133 Meridian MH dba Capital Amb	418 Limerick Rescue	646 Seasmont Rescue	859 Bremen Rescue First Responders	977 Bristol Fire and Rescue
134 Campus Seacoast Amb Service	420 Limington Rescue Unit	650 So Berwick Emergency Amb Res	860 Brewer Fire Department	978 So Bristol First Res Unit
135 Caribou Fire/Ambulance	422 Lisbon Ambulance	655 So Portland Fire Rescue	861 Bradford First Responders	979 Seasmont Rescue Unit
138 Campus Seacoast Amb Service	423 Long Island Volunteer Rescue	660 So Thomaston Amb Svc	862 Bates EMS	980 Springfield Rescue
140 Carmel Volunteer Amb Service	435 Machias Ambulance Serv	665 SWH/Tremont Nursing Svc Inc	863 Bowdoinham EMS	981 Starks Rescue
147 Casco Rescue Department	437 Madawaska Ambulance Service	670 Standish Emergency Med Svcs	865 Calais Fire Dept	982 Smithfield Rescue
150 Central Lincoln County Amb	455 Mayo Regional Hospital	672 Steering Ambulance LLC	866 Canaan Fire and Rescue	984 University of New England
155 Cushing Rescue Squad	456 Medic Works LLC	675 Stockton Springs Ambulance Svc	867 Canton Volunteer Fire and Rescue	985 Wayne Rescue
157 Cherryfield Ambulance Service	460 Memorial Amb Corps	678 Stoneham Rescue Serv	869 Canaan Municipal Fire and Rescue	986 Stetson Fire/Rescue
160 Clinton Fire Dept Amb Service	461 Meridian Mobile Health-Calais	679 Stoneham Rescue/Waterford Base	870 China Rescue Squad	987 Waterville Rescue
164 Community EMS	462 Meridian Mobile Health-Eastport	680 Sugarloaf Amb/Rescue	871 Cranberry Lakes Rescue	988 Wells Fire Dp Rescue
165 Corinna Fire Dept Ambulance	463 Meridian Mobile Health-Lubec	681 Crown Ambulance Service/PJ	872 Denmark Fire Dept 1st Responde	989 West Bath Fire Dept
168 Corinna Fire Dept. Ambulance	464 Meridian Mobile Health-Danfort	682 Swans Island Ambulance	873 Dresden First Responder	990 Winslow Fire Department/Rescue
170 Corinth Vol Amb Svc	470 Millisocket Fire Dept. Amb Svc	684 Thurston Amb Service	874 Dedham Fire Department	991 Weld Vol Fire Dept EMS Unit
172 County Amb Svc. Inc/Ellsworth	471 Minhegan Emergency Rescue Svc	685 Three Rivers Amb Serv	876 Dover-Foxcroft Fire and Rescue	992 Wilderness Rescue Team, Inc.
173 County Amb. Inc. Brunswick	473 Monmouth Rescue Assn	686 Crown Ambulance Ser.-Limestone	877 Durham Fire Responder Service	993 Woodwich Fire Department
174 County Amb. Inc. Kennebunk	477 Naples Rescue Unit	687 Crown Ambulance Serv Mars Hill	880 Eddington Fire Dept	994 Vearie Fire Department
175 County Amb. Service Inc/Belfast	480 McGovern Ambulance Svc. Inc.	689 Crown Amb. Fl. Fairfield	882 Edgcomb Fire Department	995 York Beach Vol Fire Dept
185 Cumberland Rescue Department	481 Newfield Rescue Squad	690 Topsham EMS	883 Hina First Responders	996 York Fire Department
190 Cundy's Harbor Fire Dept	482 No Berwick Rescue Squad Inc	692 Tri-Town Amb Svc/West Paris	895 Fairfield Fire Dept Rescue	997 Wilsons Mills First Responders
195 Cushing Rescue Squad	483 North Haven EMS	693 Tri-Town Ambulance Bryant Pond	905 Greenville Fire/Rescue	998 Whitefield Rescue
210 Charles A. De an Ambulance Svc	484 Med-Care Ambulance Service	697 Turner Rescue	906 Gouldsboro Fire Department	1001 Other
215 Deka Amb Corp/Waterville	485 North Yarmouth Rescue	700 Union Ambulance Service	907 Guilford Fire First Responders	
217 Delta Ambulance Corp/Augusta	486 NEMHS-Brunswick	702 United Ambulance Serv	908 Ice at Haut Rescue	
220 Denny River Volunteer Ambulance	487 NEMHS - Kennebunk	703 United Ambulance - Bridgton		
225 Dexter Ambulance Sv	488 NEMHS - Portland	705 Unity Vol Amb Corps		
230 Community Ambulance, Inc.	490 Northeast Hlth Fire Co Inc	710 University Volunteer Amb Corp		

Maine Department of Public Safety

CG-5

Form 13:20A Revised January 2010

Administrative Elements

Title 29-A §2251 Crash Reports

Definition

As used in this section, "reportable crash" means an unintended event (crash) that:

- occurs or originates on a public way or a place where public traffic may reasonably be anticipated,¹
- is caused by a motor vehicle in motion
- results in bodily injury or death to a person, or
- results in apparent total property damage of \$1,000 or more. Apparent property damage under this subsection must be based upon the market value of the necessary repairs and may not be limited to the current value of the vehicle or property.

Examples:

- *Restaurant parking*
- *Post Office parking*
- *Chain store parking*
- *Private roads open to public use (Golden Road)*
- *Public office building parking*

Examples where traffic may NOT be reasonably anticipated:

- *Apartment complex parking (only tenant and guest would reasonably expect to be present)*
- *Private property*
- *Private driveway*

¹ "Traffic may be reasonably anticipated" means any location where the general public is not restricted.

Five Elements of a Motor Vehicle Traffic Crash:

- Must be an unintended Event
- Apparent property damage totaling \$1,000 or more
- Results in bodily injury or death
- Caused by a motor vehicle in motion
- Occurs or originates on a Traffic Way

Form

The Chief of the State Police:

- Shall prepare and supply forms and approve the format for electronic submission for reports that require sufficiently detailed information to disclose the cause, conditions, persons and vehicles involved, including information to permit the Secretary of State to determine whether the requirement for proof of financial responsibility is inapplicable;
- Shall receive, tabulate and analyze crash reports;
- Shall send all crash reports to the Secretary of State; and
- May publish statistical information on the number, cause and location of crashes.

Investigation

Every reported crash shall be promptly investigated

A law enforcement officer who investigates a reportable crash **shall**

Interview participants and witnesses and provide each involved driver the **DRIVERS REPORT INFORMATION**, which shall include:

- Incident ID Number
- Date, Place and Time of the Crash
- Investigating Officer's Name and Department; and
- Other Involved Unit's information

It is imperative that this information be provided at the scene to all drivers whenever possible. Most Insurance companies will not start a claim until this information has been provided.

In the event you do not have a printer in the vehicle to print the Driver's Report Information, you MUST at a minimum facilitate the exchange of driver information between the parties.

In the event drivers are transported from the scene it is acceptable to provide the information via email, US Postal service, or to a person acting on behalf of the driver.

The Traffic Crash Report Form and all additional forms shall be completed and forwarded to the investigating officer's supervisor within 72 hours of the occurrence of the crash.

In unusual cases, where the completion of the investigation will require more than 72 hours, a preliminary report shall be submitted to the officer's supervisor as soon as possible with a notation of that fact.

It is very important for the supervisor to completely review each officer's crash report to ensure the crash data is accurate and consistent.

Within **5 DAYS** from the time of notification of the crash, transmit an electronic report or the original written report containing all available information to the Chief of the State Police. The completed report(s) shall be forwarded electronically one of three ways;

1. Via email to mcrs.mailbox@maine.gov
2. Via the automated import/export method utilizing the Criminal Justice Information Network (CJIN)
3. Via CD to State Police Traffic Division, Station 20, Augusta, Maine 04333

The Traffic Crash Report has been specifically designed to be computer generated through the Maine Crash Reporting System, (MCRS) and sent electronically to the Maine State Police Traffic Safety Division via the MCRS Mailbox.

If the crash results in serious bodily injury or death of any person, the investigation must be conducted by an officer who has met the training standards of a full-time law enforcement officer.

- A motor vehicle crash **injury** is any injury resulting from a motor vehicle traffic crash.
- A motor vehicle traffic **fatality** is any death that is a direct result of injuries received from a motor vehicle traffic crash. The death is assigned to the crash provided that death takes place within thirty days (30) of the date and time of the crash. (In any event the cause of death is to be assigned by the Medical Examiner on the death certificate.)
- In the event of a motor vehicle traffic fatality the investigating agency shall complete a teletype File 14-1 (FIRST REPORT OF FATAL) and forward immediately to the State Police Traffic Division in Augusta.

A law enforcement officer who investigates a crash involving a bus or truck with a gross vehicle weight rating or a registered weight in excess of 10,000 pounds that results in the death of any person shall request a certified crash reconstruction specialist and the Bureau of State Police Commercial Vehicle Enforcement Unit to assist in the investigation of the crash.

The Attorney General shall designate an assistant attorney general familiar with federal commercial vehicle laws and regulations to serve as a resource to any district attorney who initiates a prosecution arising from a crash involving a bus or truck with a gross vehicle weight rating or a registered weight in excess of 10,000 pounds that results in the death of any person.

Special Circumstances

Animals: The operator or owner having knowledge of a motor vehicle that has been involved in a collision with a deer, moose, bear, wild turkey, or domestic animal shall, by the quickest means, report the crash to a law enforcement officer.

When a collision with an animal occurs on a public way and meets the damage threshold of \$1000.00 or more or an injury occurs to an occupant as a result of the crash, it shall be investigated as any other reportable crash. If the crash is not on a public way the investigating officer shall check "Off Road" and code field F2 "*Type Location*" appropriately.

If the officer investigating the crash finds that the motor vehicle has sustained apparent damage as the result of a collision with a deer, moose, bear, or wild turkey, he/she shall give a certificate that entitles the person to the ownership of the carcass or to another if the damaged vehicle's owner does not want the carcass. The person may then take possession and immediately remove the entire carcass from the scene of the collision.

A person entitled to ownership of a deer, moose, bear, or wild turkey carcass under paragraph B may not take possession of or remove any portion of the carcass without taking possession of or removing the entire carcass from the scene of the collision.

Collision with Aircraft: If a motor vehicle strikes an aircraft that is not in motion, it is classified as a motor vehicle traffic crash no matter where it takes place. If, however, a motor vehicle strikes an aircraft in motion, the event is classified as an air transport crash. All aviation occurrences should be reported to the FAA Communications Center at 617-238-7001.

Crashes and Pregnancy: Abortions, miscarriage, death of a live-born baby resulting from prenatal motor vehicle crash injury, or still birth resulting from a motor vehicle traffic crash IS NOT classified as a motor vehicle traffic crash fatality.

Death Preceding a Crash: If an individual is found dead after a crash and there is evidence that the death was the result of disease or other causes, the death WILL NOT be assigned to the crash if the attending Medical Examiner confirms that death preceded the crash.

Driverless Motor Vehicle: When a reportable crash is caused by a driverless motor vehicle in motion, even though the motor vehicle had been properly parked before, the event is classified as a motor vehicle traffic crash. (In such cases, the LAST KNOWN DRIVER would be used in the "*Person Type*" field and full data on that person would be included in the crash report.)

If damage is caused to motor vehicles being displayed on a dealership lot, they are not considered as separate vehicles in the crash, but their damages should be added to the total damage of the crash.

Example1: A motor vehicle loses control, leaves the traffic way, and strikes three parked vehicles being displayed for sale on a dealer's lot. This would be classified as a single vehicle motor vehicle traffic crash and the total damage of all four vehicles would contribute to meeting the damage threshold.

Example 2: A motor vehicle loses control, leaves the traffic way, and strikes a vehicle being displayed For Sale by a private owner on his or her property that has not been in regular use. This would be classified as a single motor vehicle traffic crash and the total damage of the parked vehicle contributes to meeting the damage threshold.

Example 3: A motor vehicle loses control, leaves the traffic way, and strikes an unoccupied vehicle that was recently driven to the side of the road and parked or recently driven to a private property and parked. Because these vehicles are readily in use and are parked temporarily, all vehicles involved would be considered units in the crash.

Fall From a Motor Vehicle: If a person falls from a moving motor vehicle and is injured or causes damage, the event would be classified as a motor vehicle traffic crash. (If a person intentionally jumps from a moving motor vehicle, regardless of the effects, the event IS NOT classified as a motor vehicle traffic crash.)

Fire: Fire that is caused by the motion of the moving motor vehicle and which results in damage or injury is classified as a motor vehicle traffic crash.

Injury to Non-Occupant: If a person not an occupant of a motor vehicle is injured as a result of contact with any part of the moving motor vehicle, or any object carried on the moving motor vehicle, or by an object set in motion by the moving motor vehicle, the crash is classified as a motor vehicle traffic crash. For example: a crash is classified as a motor vehicle traffic crash if a pedestrian is struck by the motor vehicle; or is injured as a result of his clothes catching on a moving motor vehicle; or becomes entangled in a rope dragging behind a moving motor vehicle; or is struck by an overhanging load on a moving motor vehicle; or if through physical contact with a moving motor vehicle, the pedestrian is crushed against a wall, forced over a cliff, etc.

Intent: If a person intentionally uses a motor vehicle to cause damage, injury, or death, the event would not be classified as a motor vehicle traffic crash.

Late Reported Crash: When an officer receives a late report of a crash, arrangements should be made to meet the involved party at the location of the crash, whenever possible. The scene should be examined to ensure there actually was a crash, and to ascertain that the vehicle damage corresponds to the events as stated. Depending on the location of the crash it may be much safer to meet at a location other than where the accident occurred and then the officer only confirms the location when safe to do so: *For example - The crash occurred on a bridge on I-95 during rush hour traffic.*

Mechanical Failure: Breakage of any part of a motor vehicle in motion that results in injury, death, or damage in the apparent amount of \$1000 or more is a motor vehicle traffic crash.

Object Falling From a Motor Vehicle: If an object falls from a motor vehicle in motion and causes injury or damage, the event would be classified as a motor vehicle traffic crash.

Originating On a Traffic Way: If a motor vehicle leaves the traffic way prior to sustaining damage or causing injury or death, the event is still classified as a motor vehicle traffic crash.

Private Property: A motor vehicle crash occurring on the driveway of a private home, duplex, apartment complex, in an industrial yard, on a racetrack, in a field, on the ice of a lake, or at any other location not customarily used by the public, is classified as a non-traffic crash.

Private Road: A private road is a traffic way only if it connects two public roadways and is customarily used by the public to travel from one public roadway to the other. A private road running across a railroad yard or a college campus, which is customarily used by vehicular traffic from a traffic way on one side of the property to another traffic way, is classified as a traffic way. Private roads are not traffic ways if they are used only as a means of access to or exit from private property, even though they cross a railroad right-of-way.

Pursued Vehicles: When a pursued vehicle is involved in a crash and the police vehicle is not involved by contact, the police vehicle shall not be included as an involved unit. It should be documented in the narrative the crash vehicle was being pursued.

Road under Construction: A road way under construction does not lose its classification as a traffic way UNLESS traffic is prohibited from unrestricted use of the road. If one lane of a two-lane road is open for traffic, that lane is a traffic way and the closed lane is not.

Stabilized Event: A crash event is considered stabilized when either the vehicles come to rest, or all injury or damage from the collision has occurred. Any collision occurring after the initial event becomes stabilized would be considered a separate event.

Example 1: Hit and Run pedestrian crash; the vehicle never comes to final rest as a result of collision forces, therefore the event would be considered stabilized when the pedestrian comes to final rest. If a second vehicle strikes the pedestrian after coming to final rest, it is considered a separate crash.

Example 2: A multi-vehicle crash in a snowstorm; If the crash is a chain reaction, with all vehicles striking each other at relatively the same time, it is one crash, however, if two vehicles collide and come to rest in the roadway and are then struck by a third vehicle, it is two crashes.

Terminating On a Traffic Way: If a crash begins on private property, but collision or damage or injury (or death) occurs while crossing a traffic way, the event would be classified as a motor vehicle traffic crash.

Toll Roads/Bridges: The fact that a toll or fee is charged for the use of a traffic way does not remove it from the classification.

Uninvolved Vehicles: When a vehicle causes or in any way is involved in a crash, but not actually involved by contact, it SHALL be considered as part of the Crash and included on the report. When the vehicle data is unknown, select "OTHER" in the Unit 2 "Unit Type" field and code fields U8 and U10 as appropriate for its actions.

Crash Report Structure

Location Elements

The following crash data element numbers coincide with the 13:20 Quick Reference where the data elements are identified by number on the form.

Incident Information

1 ORI (Originating Agency Number)

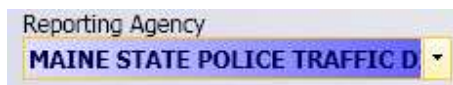
A screenshot of a software interface showing a dropdown menu. The label 'Reporting Agency' is at the top. The selected option is 'MAINE STATE POLICE TRAFFIC D'.

The ORI is a unique identifier for every law enforcement agency. It is important that it be correct and complete.

The first two Characters identify the State. The next (3) digits identify the county in which the agency resides. The next four (4) digits identify the agency's jurisdiction number that is assigned by the NCIC (FBI) and coordinated by the Maine State Police Access Integrity Unit (AIU).

Example 1: ME MSP 0A00 ME: Maine, MSP: Statewide, 0A00: Troop A

An officer working for the Maine State Police should use the ORI of the troop the crash occurred in.

Example 2: ME 006 0100 ME: Maine 006: County (Kennebec is sixth county alphabetically) 0100 is Augusta PD main ORI.

The last two (2) digits of the agency identifier are normally zeros (00), unless the AIU has assigned a specific Sub-ORI number to another agency terminal or mobile unit.

Example 3: ME 006 0107 ME: Maine 006: County (Kennebec is sixth county alphabetically) 0107 is an Augusta PD sub-ORI.

The ORI can be set in the user settings to automatically populate upon starting a new crash.

2 Report Number

A screenshot of a software interface showing a text input field. The label 'Report Number' is at the top. The text 'SP10-123456' is entered in the field.

Definition: The unique identifier (report number) within a given year that identifies a given crash within a state.

Rationale: Used to document a specific crash. If this identifier is available at the scene, it can also be recorded on the EMS record for linkage purposes. Enables subfiles to be created for analysis and linked back to the crash data file.

This is each agency's individual incident number for each crash. The numbers should be consistent by department and shall not contain spaces or special characters. The number can be up to 25 characters long and should only contain letters from A to Z, numbers from 0 to 9 and dashes

Example 1: An officer from Maine State Police would enter SPfour digit year- before the assigned six digit case number. SP2010-012345

Example 2: A police department using IMC's crash report module would use a number such as: 10ELI-22-AC or 10-30-AC

Example 3: A police department using MCRS may use a number such as: WS10-01988 or 2010-00566.

Crash Date



Crash Date
6/8/2010

Enter the date of the crash using digits from 0-9. You must enter the crash as mmddyy or yyyy/mm/dd . You may also left click your mouse on the calendar to the right of the "Crash Date" and left click on the appropriate month and day.

Crash Time

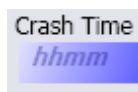

Crash Time
hhmm

Enter the time of the crash using digits from 0-9. **You must enter the time using the military format.** Midnight is defined as 0000 to represent the beginning of a new day. (1200 is noon) It is not necessary to enter the colon.

At Scene Date



At Scene Date
6/8/2010

Enter the date of arrival at the crash scene using digits from 0-9. You must enter the crash as mmddyy or yyyy/mm/dd. You may also left click your mouse on the calendar to the right of the "At Scene Date" and left click on the appropriate month and day.

At Scene Time

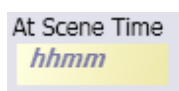

At Scene Time
hhmm

Enter the time of arrival at the crash using digits from 0-9. **You must enter the time using the military format.** It is not necessary to enter the colon.

Location

Definition: The exact location on the roadway to document where the *first harmful event* of the crash occurred.

Rationale: Accurate crash locations are Critical for problem identification, prevention programs, engineering evaluations mapping, and linkage purposes.

3 Off Road or IFW

OffRoad or IFW

Use this check box if the crash occurred off road (not on a public way or publicly accessible roadway) or an off road crash assigned to Maine Warden Service.

You can check this box by hovering your mouse over the box and left clicking or when the field is highlighted pressing the space bar. You can uncheck the box using the same procedures.

4 Type Location



Definition: The type location describes the location where the crash occurred.

Straight Road: If the predominant characteristic of the road in the area of the crash is straight.

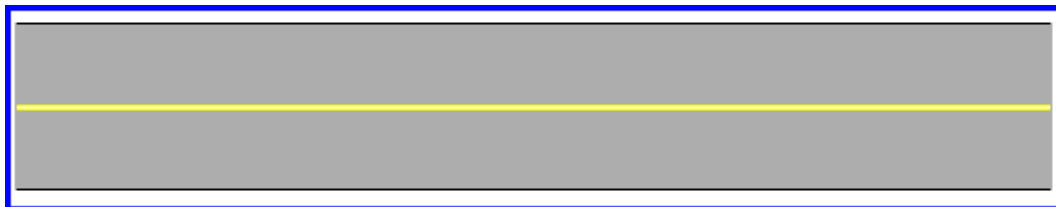

Curved Road: If the predominant characteristic of the road in the area of the crash is curved.

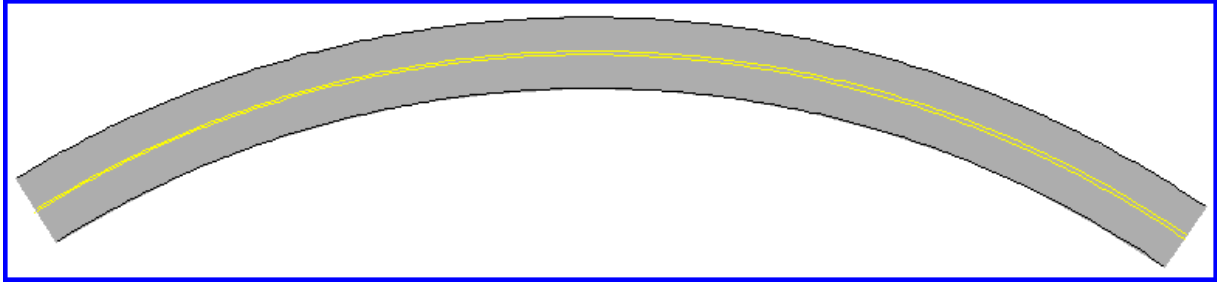

Three Leg Intersection: If the crash occurred as a result of movement in or about a three leg intersection. If the crash occurs within **100 Feet** of the center of the intersection the crash would be considered at the intersection.

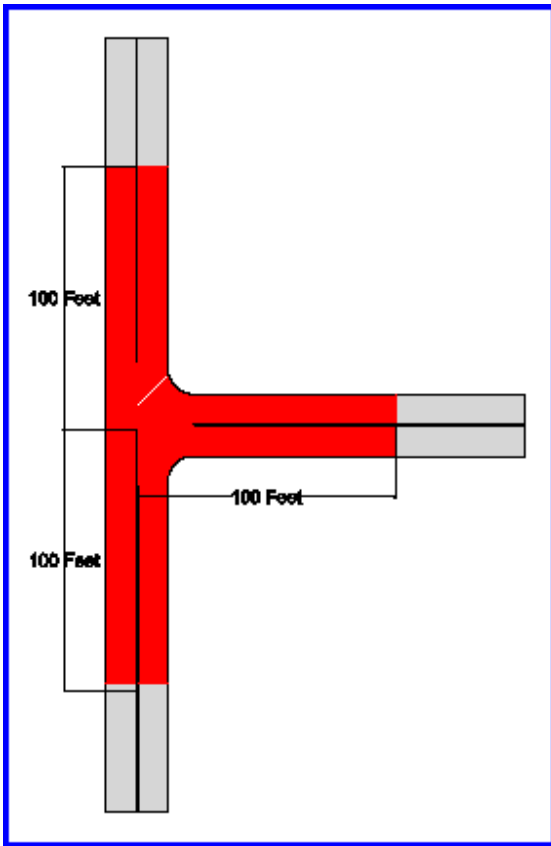

Four Leg Intersection: If the crash occurred as a result of movement in or about a four leg intersection. If the crash occurs within **100 Feet** of the center of the intersection the crash would be considered at the intersection.

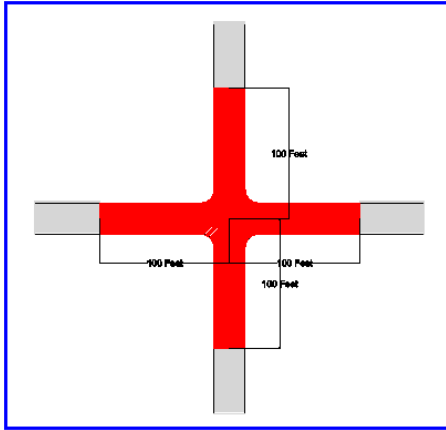

Five or More Leg Intersection: If the crash occurred as a result of movement in or about a five or more leg intersection. If the crash occurs within **100 Feet** of the center of the intersection the crash would be considered at the intersection.

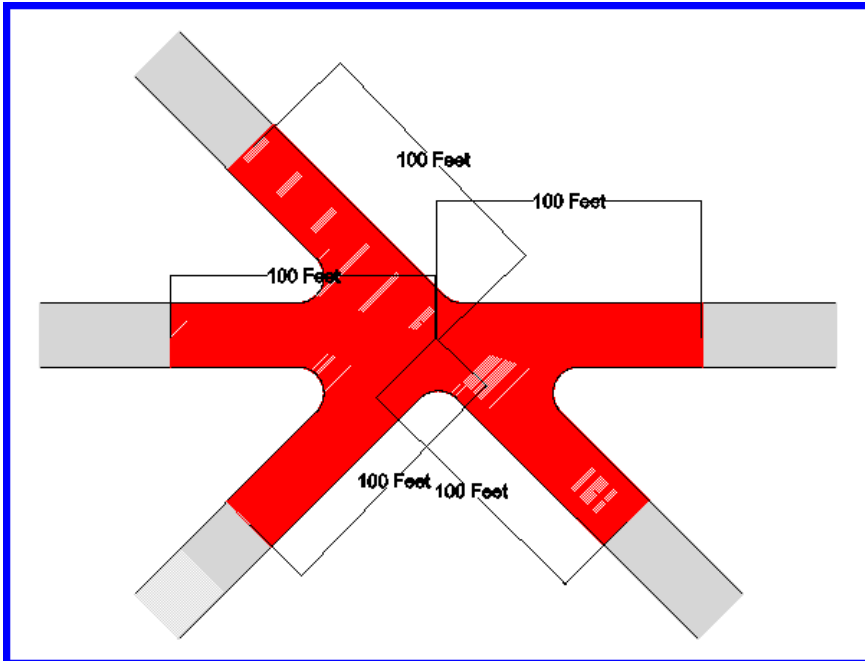

Driveway: If the crash occurred as a result of movement in or about a driveway. A driveway is a private way which provides vehicular access to a private residence, or provides access to the public from a trafficway to property, parking, or loading areas outside the boundaries of the trafficway, but is considered to be not open to the public for transportation purposes as a trafficway.

Example 1:

A vehicle is making a left turn into a private residence driveway and is struck by an oncoming vehicle. This crash would be coded as "Intersection Movement" Type Crash and "Driveway" Type Location.

Example 2:

A vehicle is stopped waiting to make a left turn into a McDonald's entrance and is struck from behind. This crash would be coded as "Rear-end/Sideswipe" Type Crash and "Driveway" Type Location.

Example 3:

A vehicle is exiting a McDonald's Parking Lot and is struck by an oncoming vehicle. This crash would be coded "Intersection Movement" Type Crash and "Driveway" Type Location.

Bridge: If the crash occurred as a result of movement on a bridge.

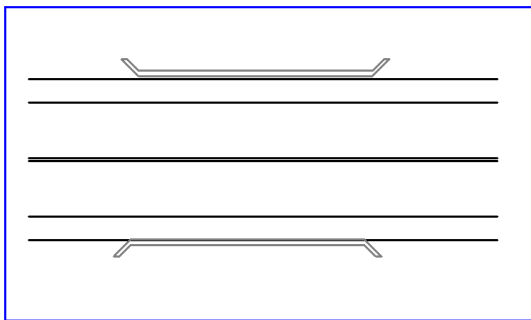

Interchange: If the crash occurred as a result of movement in or about the boundaries of an interchange which includes all ramps of auxiliary roadways and includes each roadway entering or leaving the interchange to a point 100 feet beyond the curb return at the outermost ramp connection.

An interchange is a system of interconnecting roadways in conjunction with one or more grade separations, providing for the movement of traffic between two or more roadways on different levels.

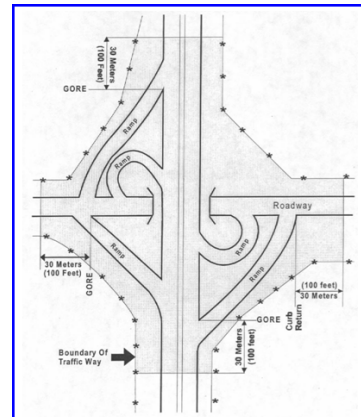

Trail: If the crash occurs on a recreational trail defined as follows: A designated land corridor or body of water that provides recreational, aesthetic, alternate transportation or educational opportunities to off-road motorized and non-motorized users.

Open Field: If the crash occurs in an open field area away from a trail.

Gravel Pit: If the crash occurred away from a trail in an area classified as a gravel pit, rock quarry etc.

Woods: If the crash occurs in a wooded area away from a trail or field.

Lake/Pond: If the crash occurs on a body of water classified as lake or pond.

River/Stream: If the crash occurs on a body of water classified as a river or stream.

Ocean: If the crash occurs on a body of water classified as an ocean.

Parking Lot: If the crash occurred in a parking lot.

- A parking lot is an area used primarily for parking road vehicles. When paved and marked, it commonly includes the following areas:
- Parking stalls — areas reserved primarily for parked road vehicles
- Parking lot aisles — areas used primarily for vehicular access to parking stalls. Parking lot aisles are not trafficways.
- Parking lot ways — land ways which are used primarily for vehicular circulation within parking lots and for vehicular access to parking lot aisles.



Private Way: If the crash occurred on a road or right of way which is privately owned and maintained but the public has open access to.

Cross Over: If the crash occurred as a result of movement in or about a highway median space or median crossover. A Cross Over is an area of the median of a divided trafficway where authorized motor vehicles can, with permission cross the opposing lanes of traffic or do a U-turn.

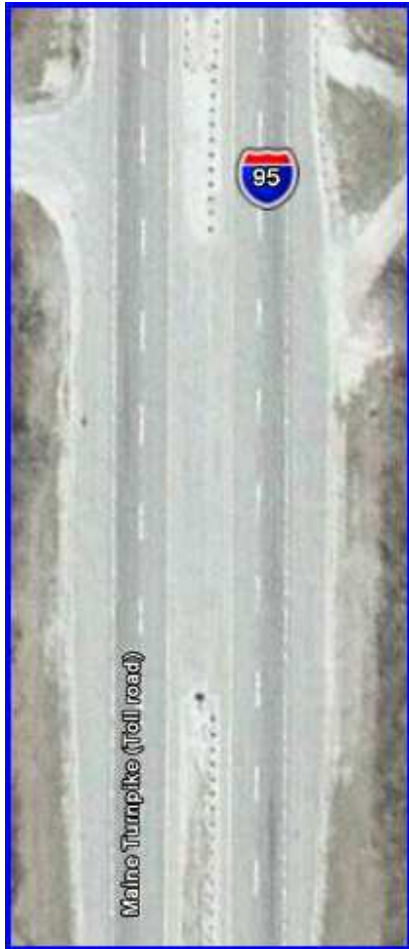

Railroad Crossing: If the crash occurred in a railroad crossing.

A Railroad Crossing is an intersection between a roadway and train tracks which cross each other at the same level (Grade).



Traffic Circle/Roundabout: If the crash occurred as a result of movement in or about a roadway classified as a traffic circle, rotary, or roundabout.

A Traffic Circle is an intersection where vehicles must travel around a circle to continue on the same road or leave on any intersecting road.



A Roundabout is a circular traffic pattern in which yield control is used on all entries, circulating vehicles have right of way, pedestrian access is allowed only across the legs of the roundabout behind the yield line and circulation is counter-clockwise and passes to the right of the central island.



Other: Only select “Other” if none of the other listed “crash type” descriptions are appropriate.

City or Town

Definition: The city/place (political jurisdiction) in which the crash occurred.

Rationale: The City or Town where the crash occurred is important for analyses of local area programs such as Safe Communities. City or Town of the crash is critical for linkage of the crash file to other state data files (EMS, hospital, roadway, etc.).

Enter the city or town where the crash occurred. You may utilize a “type-ahead” function by starting to type the beginning letters of the city or town or you may utilize the “drop-down” menu and select the city or town.

MAP

The map function will allow the user to locate the crash using map files provided by the Maine Department of Transportation. After populating the “City” field and selecting the “MAP” function, a map of the city or town you entered will populate the screen. Find the area in which the crash occurred and click on the location. The following fields will automatically be populated:

- The “Street or Highway” field
- The “Nearest Intersecting Street” field
- The “Direction from Nearest Intersection” field
- The “Distance” field
- The ‘Latitude’ and ‘Longitude’ fields

To be affective at pinpointing safety problems and leverage funding to address needed safety improvements it is imperative the *Map Function* be used in order to ensure crash locations are identified accurately.

Street or Highway

When not using the map system or the crash occurs Off-Road or in a parking lot you can manually enter the name of the Street or Highway.

You should only manually enter a street name if the crash occurred on a roadway that is not yet included in the map files or if the crash occurred in a parking lot.

Please enter the full name of the street with no abbreviation. It is acceptable to abbreviate Street as St., Road as Rd., Avenue as Ave., and Boulevard as Blvd.

Examples: Main St, High St, Rodman Rd, Seaway Blvd

5 Nearest Intersecting Street

When not using the map system or the crash occurs Off-Road or in a parking lot you can manually enter the name of the nearest intersecting street or off-ramp.

Direction from Nearest Intersection



When not using the map system or the crash occurs Off-Road or in a Parking lot, select the primary direction **TO** the crash scene **FROM** the nearest intersection. If you are within **100 feet** of the intersection choose “**At Intersection.**”

6 Distance and Units



When not using the map system or the crash occurs Off-Road or in a parking lot you can manually enter the distance **FROM** the “Nearest Intersection” **TO** the crash site.

The distance should be entered in miles and tenths or in feet.

Example 1: If the crash occurred approximately 200 feet from the nearest intersecting street you would enter 0.04 Miles or 200 Feet.

Example 2: If the crash occurs 1.5 miles from the nearest intersection you would enter 1.5 Miles or 7920 Feet.

7 Latitude and Longitude

Latitude	Longitude
###.#####	-###.#####

The optimum definition of Crash Location is a route name and GPS (global positioning system)/GIS (geographic information system) locator, if a highway agency has a linear referencing system that can relate geographic coordinates to specific locations in road inventory, traffic, driver, and other files. The location information in a crash file must have the capability to be linked to location information in these other important files required to study site-specific safety issues. GPS/GIS provides the latitude/longitude coordinates indicating where the crash occurred.

When not using the map system or the crash occurs Off-Road or in a parking lot you can manually enter the Latitude and Longitude.

Special Note for IMC User's

If you are an IMC user you will not have the map function built into your system and you will need to locate your crashes using the Node and Element system.

Use the following procedure to enter Nodes and offset distances in the IMC system:

While in the "Control" page of IMC, proceed to the "Distance" box and enter the total distance from the node or intersection to the crash. The investigating officer shall measure the distance from a Node to the crash scene.

Tab over to the "Measure" box and utilize the dropdown menu and select either Tenth(s) or Mile(s). To complete the node portion of the report you must proceed to the "Collision" module.

At the Collision page of IMC:

1. Determine if the crash occurred at a Node or within an Element (between Nodes)
2. If a crash occurs within 100 feet of intersection or at a node, use only Node #1 on the "Control" page of IMC.
3. If the crash occurs between two nodes, the officer shall enter both node numbers. Node #1, Node #2 and "To Node". Example: "Node #1": 58492 and "Node #2": 58493 "To Node": 58492. The "to Node" is where the officer chooses to measure to the crash. It must be one of the two node numbers given.
4. Utilizing IMC database to search for node number:
5. While in the "Collision" module, highlight "Node #1" box, then press F4 this will prompt the heading box. Enter the "road name to search for" appropriate location. "Leave blank for all" to see all the streets listed in IMC database. If not within the 100 feet of a node or intersection, repeat the above step for "Node#2" and "to Node".

IMC Landmark System

Landmarks used to locate crashes will be either town lines or intersections of routes each bearing route numbers. If neither can be obtained, it is permissible to use intersecting roads or streets, which have names rather than numbers. Use landmarks when IMC is not recognizing a road, possibly due to being private (only when the public has access) or a parking lot.

When using landmarks, the officer shall include direction and distance from crash to landmark. In the “Control” page of IMC, tab over to the “Direction” box and utilize the dropdown menu. Select either North, South, East, or West. Next tab over to “Of” box and enter the landmark. This is a free text box so be specific.

Example:

A crash occurs in the Wal-Mart Parking Lot in Biddeford. The free text should read “1.1 miles to Route 111”. Note: The crash location will already be listed in the location section in the Control page.

Environment

The Environmental section of the Location page is where the officer documents the specific data of the crash location and circumstances including the road condition, weather condition, traffic control device, damage threshold, contributing circumstance of the road and environment.

The Environment data fields provide a major portion of the information required for proper analysis of Maine’s Crash picture, and aids in the coordination of the many selective enforcement programs within the State.

The investigating officer **MUST PROPERLY CODE** every Crash investigated if the system is to be meaningful. Certain code categories must be filled in on ALL Crashes while others may be completed on a need basis.

8 Posted Speed Limit

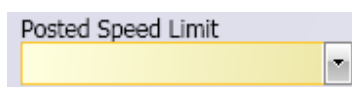

Choose from the drop down menu, the posted/statutory speed limit of the road where the crash occurred.

The 2009 Manual on Uniform Traffic control Devices (MUTCD) states a Regulatory or Statutory speed limit sign is one that contains a white background with a black legend (daytime) or black background with a white legend (nighttime). The speed warning signs as defined by MUTCD contain a yellow background with a black legend. These warning signs are not considered regulatory or statutory speed limits and should not be selected as such. If a speed warning sign exists in the crash area it should be noted in the traffic control devices field of MCRS by selecting “Advisory/Warning Sign”.

9 Type Crash



Definition: Type Crash describes the vehicle traffic crash in terms of type with respect to the First Event that leads to the crash.

Object in Road: A crash where the vehicle strikes an object in the roadway, which causes injury or damage.

Rear end/ Sideswipe: A crash involving two or more vehicles which are traveling in the same direction, regardless of vehicle orientation.

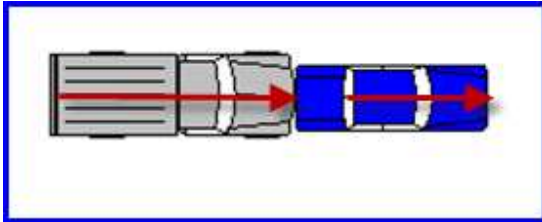

Example 1:

A vehicle is stopped at an intersection or driveway waiting to turn and is struck from behind. This would be coded as a rear-end/sideswipe type crash.

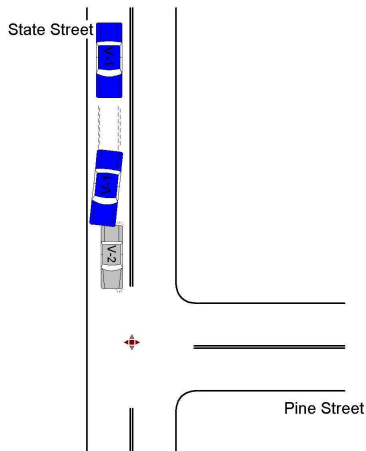

Head-on/ sideswipe: A crash involving two or more vehicles which are traveling in the opposite direction, regardless of vehicle orientation.

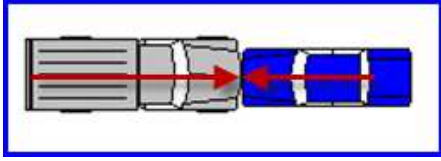

**** Codes 2 and 3 refer to the direction the vehicle is traveling, not the direction the vehicle is heading. For example, if a vehicle was traveling south and spun 180 degrees on an icy road and then struck a vehicle that was traveling north, the crash should be coded as a Head On, because the vehicles were traveling in opposite directions.**

Intersection Movement: When two or more vehicles collide while in the process of **moving** in or about an area classified as an intersection or driveway.

Example 1:

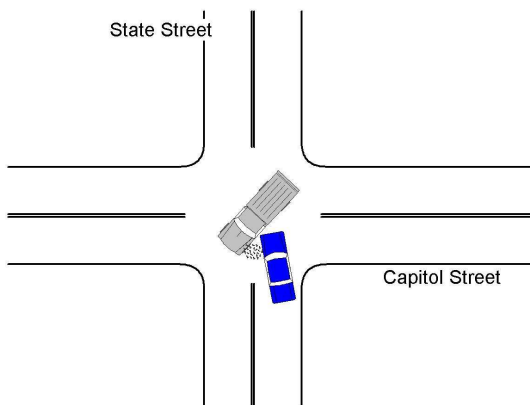

A pickup making a left turn from Capitol Street to State Street is struck by a vehicle traveling straight through the intersection would be coded as an intersection movement type crash.

Example 2:

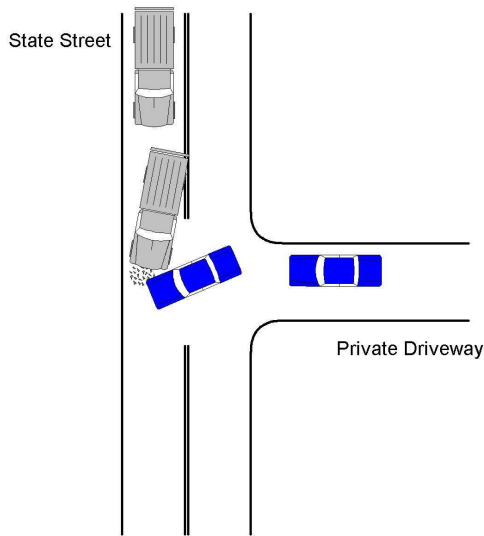

A vehicle exiting a private driveway and fails to yield to on coming traffic would be coded as an intersection type movement crash.

Pedestrians: Any collision between a motor vehicle and a person on foot in the roadway.

Inclusion Example:

- *A vehicle operator is changing a tire on the shoulder of the road and is struck by a passing vehicle would be coded as a pedestrian type crash.*
- *A person leading or walking a horse on the side of the road and the person is struck first.*

Exclusion Examples:

- *A vehicle operator is changing a tire on the shoulder of the road. A vehicle strikes the rear of the disabled vehicle before striking the pedestrian. This crash type would be coded Rear-end/sideswipe.*
- *A motor vehicle is stopped waiting for a pedestrian and gets struck in the rear by another vehicle.*

Train: Any collision between a motor vehicle and a train

Went off Road (left or right): When the vehicle leaves the roadway prior to any other harmful event.

Example 1: A vehicle is traveling on a divided highway, leaves the roadway, y travels through the median and rolls over. The “Type Crash” would be coded as “Went off Road.”

Example 2: A vehicle leaves the roadway and strikes a utility pole. “Type Crash would be coded as Went off Road.”

Example 3: A vehicle traveling south on a divided highway leaves the travel lane, travels through the median, enters the north bound lane and strikes a vehicle head-on. “Type Crash” would be coded as “Went off Road.”

All Other Animal: Any collision between a motor vehicle and an animal other than a bear, deer, moose or turkey.

*Inclusion: This would include a horse being **ridden** on the side of the road that is struck by a motor vehicle.*

Bicycle: Any collision between a motor vehicle and a sled or bicycle, provided the sled or bicycle is being **ridden** at the time of the collision

Other: Only select “Other” if none of the other listed “crash type” descriptions are appropriate.

Jackknife: An uncontrolled articulation between a tractor and trailer(s) or vehicle towing a trailer, which is the first event of the crash.

Rollover: A motor vehicle that has overturned at least 90 degrees to its side prior to leaving the roadway. The rollover must be the **first event** in the crash.

Fire: A fire or explosion that is caused as a result of the vehicle being in motion.

Example 1: A vehicle is in transport (motion) and oil is leaking on the exhaust which results in a fire while the vehicle is moving. “Type Crash” would be coded as “Fire” if the damage meets the threshold requirement.

Example 2: A commercial vehicle in transport (motion) is experiencing brake problems and one brake overheats and ignites. “Type Crash” would be coded as “Fire” if the damage meets the threshold requirement.

Immersion: An event where an object or person becomes covered completely with liquid without leaving the roadway.

Thrown/ Falling Object: A motor vehicle is struck by falling, shifting cargo or anything set in motion by a motor vehicle.

Remember that a vehicle’s load is considered part of the vehicle. For example, if cargo falls from a truck (in transport) and strikes another vehicle in transport, this is treated as a two-vehicle crash. This attribute would apply as the First Harmful Event in that situation.

Bear: A collision between a motor vehicle and a Bear

Deer: A collision between a motor vehicle and a Deer

Moose: A collision between a motor vehicle and a Moose

Turkey: A collision between a motor vehicle and a Turkey

10 Weather Condition

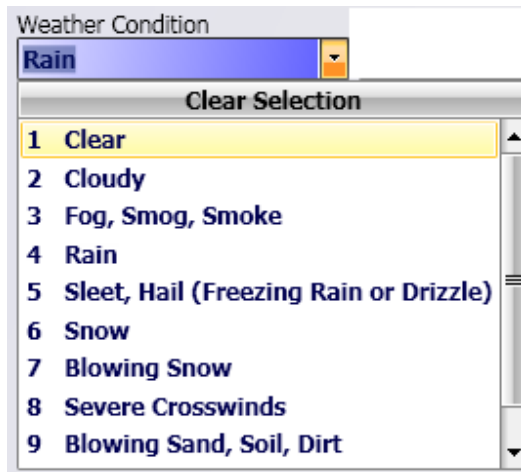

Definition: The prevailing atmospheric conditions that existed at the time of the crash.

Rationale: Important for management/administration and evaluation. This field is critical for prevention programs and engineering evaluations.

Clear: This includes partial cloudiness if sunlight is not diminished.

Cloudy: Usually "overcast" but may include partial cloudiness if light is diminished.

Fog, Smog, Smoke: Natural or man-made condition that causes reduced visibility.

Rain: Used when precipitation is falling as rain at the time of the crash.

Sleet, Hail (Freezing Rain or Drizzle): This attribute would apply to conditions where precipitation is falling as ice (sleet/hail) or when it is falling as liquid (rain) and then freezing on the roadway.

Snow: Used when precipitation is falling as snow at the time of the crash.

Blowing Snow: Applies to snow that is falling and/or to snow that has fallen to the ground and is set aloft by wind.

Severe Crosswinds: Refers to winds traveling at an angle with respect to the travel lanes at velocities significant enough to create a risk that vehicles could be diverted from their path or high profile vehicles could be blown over. These are winds that are strong enough to affect vehicle stability.

Blowing Sand, Soil, Dirt: Refers to particulate matter set aloft by winds creating a condition of reduced visibility which constitutes a hazard for vehicles operating in the area. This code should be used for “dust storms”. This code should not be used in conjunction with Severe Crosswinds unless the winds are affecting vehicle stability in addition to reducing visibility.

Other: Only select “Other” if none of the other listed “weather condition” descriptions are appropriate.

11 Light Condition



Light Condition

Daylight

Clear Selection

1 Daylight

2 Dawn

3 Dusk

4 Dark - Lighted

5 Dark - Not Lighted

6 Dark - Unknown Lighting

7 Unknown

Definition: The type/level of light that existed at the time of the motor vehicle crash.

Rationale: Important for management/administration and evaluation. This field is critical for prevention programs and engineering evaluations.

Daylight: Describes a condition where “natural” light exists on the roadway where the crash occurs.

Dawn: The transition period going from "dark of night" to a daylight condition. This is typically the 30 minute period before the sun rises.

Dusk: The transition period going from a daylight condition to the "dark of night". This is typically the 30 minute period after the sun sets.

Dark-Lighted: Describes a condition where no "natural" light exists but overhead "man-made" lighting is present on the roadway where the crash occurs.

Dark – Not Lighted: Describes a condition where no "natural" light exists and no overhead "man-made" lighting is present on the roadway where the crash occurs.

Dark – Unknown Lighting

Other: Only select “Other” if none of the other listed “light conditions” descriptions are appropriate.

Unknown: Only select “Unknown” when the light conditions that existed at the time of the crash are unknown.

12 Road Grade

Road Grade

Level

Clear Selection

1 Level

2 On Grade

3 Top of Hill

4 Bottom of Hill

5 Other

Definition: The geometric or layout and inclination characteristics of the roadway in the direction of travel for this vehicle.

Rationale: Important to document the horizontal alignment and grade of the roadway as it relates to this specific vehicle involved in the crash for the purpose of evaluating vehicles that run-off-road, rollover, or are runaways.

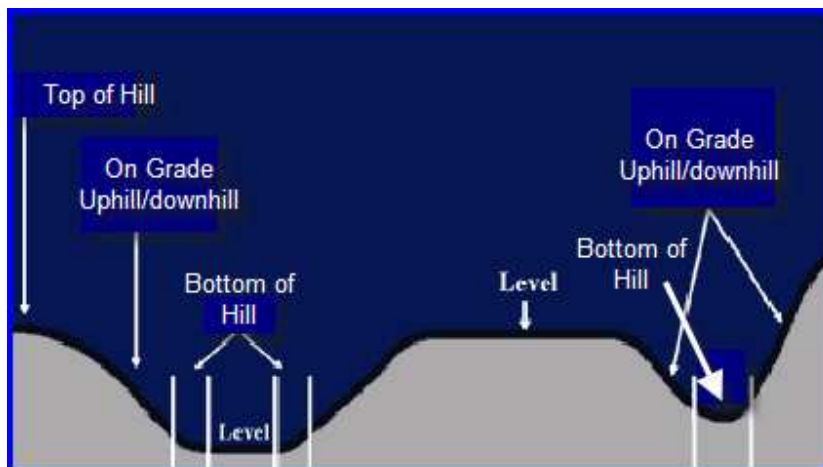

Level: Predominately flat.

On Grade: Area with positive or negative inclination.

Top of Hill: Area on grade at crest of hill.

Bottom of Hill: Area on grade at bottom of hill.

Other: Only select “Other” if none of the other listed “road grade” descriptions are appropriate.

Road Surface Condition



Definition: The roadway surface condition at the time and place of a crash.

Rationale: Important to identify and correct high wet-surface crash locations and provide information for setting coefficient of pavement friction standards. This field is critical for prevention programs and engineering evaluations.

Dry: Describes a roadway that is free from liquid or moisture.

Wet: Describes a roadway surface that is covered with water from rain or melted snow, etc.

Snow: Describes a roadway surface that is covered with snow.

Slush: Describes a roadway surface that is covered with melting snow.

Ice/Frost: Would include a roadway covered with ice from freezing rain, black ice, or other sources.

Water (standing, moving): Would describe a roadway surface that is covered with an excessive amount of water usually attributed to flooding and typically localized.

Sand: Would include sand on the roadway as a result of sand blown by wind or sand discharged on the roadway by highway trucks.

Mud, Dirt, Gravel: Would indicate these substances present on the surface of the roadway at the crash location, not the surface type of the roadway by design.

Oil: Would include fuel spilled on the roadway.

Other: Would include spilled substances such as grain, wet leaves, and liquids other than those listed above. **Only select “Other” if none of the other listed “road surface condition” descriptions are appropriate.**

Unknown: **Only select “Unknown” when the light conditions that existed at the time of the crash are unknown.**

Traffic Control Device

Traffic Control Device

None

Clear Selection

- 1 Traffic Signals (Stop & Go)
- 2 Traffic Signals (Flashing)
- 3 Advisory/Warning Sign
- 4 Stop Signs - All Approaches
- 5 Stop Signs - Other
- 6 Yield Sign
- 7 Curve Warning Sign
- 8 Officer, Flagman, School Patrol
- 9 School Bus Stop Arm

Definition: The type of traffic control device (TCD) applicable to this motor vehicle at the crash location. Pavement markings are included under Pavement Markings, Longitudinal.

Rationale: This element needs to be collected at the scene because the presence of specific devices is better verified at the time of the crash. It is also important for ascertaining the relationship between the use of various traffic control devices (TCD) and crashes, and identifying the need for upgraded TCDs at specific crash locations.

Enter the code that describes the predominant traffic control device at the scene of the crash that regulates the intersection or roadway. Note that this data element is designed to collect information about traffic controls at the scene of the crash **WITHOUT** regard to whether or not a traffic control (or malfunction thereof) was related to the crash.

Warning Signs (From the Manual on Uniform Traffic Control Devices are used when it is deemed necessary to warn traffic of existing or potentially hazardous conditions on or adjacent to a highway or street.



Regulatory Signs (From the Manual on Uniform Traffic Control Devices) are used to inform road users of selected traffic laws or regulations and indicate the applicability of the legal requirements.



Traffic Signals (Stop and Go): Controls traffic movements by illuminating systematically, a green, yellow, or red light.



Traffic Signals (Flashing): Traffic control signal that is flashing or a single light flashing red or yellow.

Stop Signs – All Approaches: An intersection where each leg of the intersection is controlled by a stop sign.

Stop Signs- Other: An intersection where not all approaches are controlled by a stop sign.

Yield Sign: A location where one approach is regulated by a yield sign.

Curve Warning Sign: A cautionary sign used to warn of approaching curve.



Officer, Flagman, School Patrol: Location where a person is in charge of regulating traffic flow.



School Bus Stop Arm: When school bus stop arm is extended and red lights are flashing.

School Zone Sign: Signs which change the speed limit on roads adjacent to a school on school days; signs which give advance warning of a school; and signs which warn of children crossing the road.

R.R. Crossing Zone: Any sign, signal, or gate that warns of on-coming trains or train tracks crossing the roadway.



No Passing Zone: Area where a regulatory sign or road line markings prevents passing.

Cautionary Speed: Location where speed limit is temporarily reduced due to weather, construction etc.

None: No controls.

Other: Any regulatory sign or signal not appropriate for the other categories of Stop or Yield. **Only select "Other" if none of the other listed "traffic control device" descriptions are appropriate.**

15 Traffic Control Device Operational



Traffic Device Operational

Clear Selection

- 1 Yes
- 2 No
- 3 Unknown

Definition: Was traffic device operational at time of crash?

Yes: Working properly.

No: Not working, obscured, knocked down.

Unknown: Only select “Unknown” if it is not known if the traffic control device was working properly at the time of the crash.

16 Location of First Harmful Event

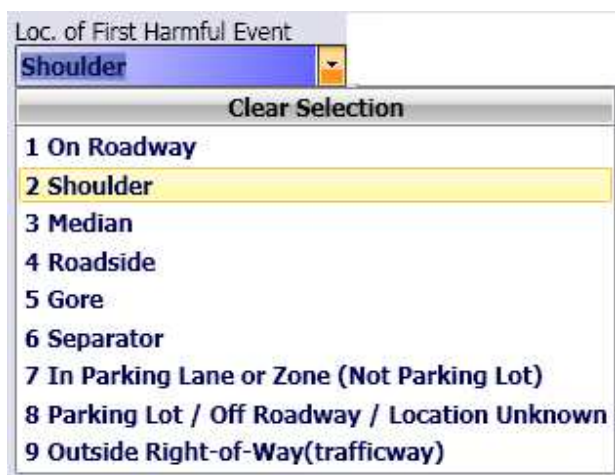

Loc. of First Harmful Event

Shoulder

Clear Selection

- 1 On Roadway
- 2 Shoulder
- 3 Median
- 4 Roadside
- 5 Gore
- 6 Separator
- 7 In Parking Lane or Zone (Not Parking Lot)
- 8 Parking Lot / Off Roadway / Location Unknown
- 9 Outside Right-of-Way(trafficway)

Definition: The location of the First Harmful Event as it relates to its position within or outside the trafficway.

Rationale: Important to identify highway geometric deficiencies.

Trafficway Clarification: A trafficway is any land way open to the public as a matter of right or custom for moving persons or property from one place to another. A Trafficway's boundaries are from property line to property line. It includes the Roadside, Roadways (travel lanes), Medians, Separators and Shoulders.

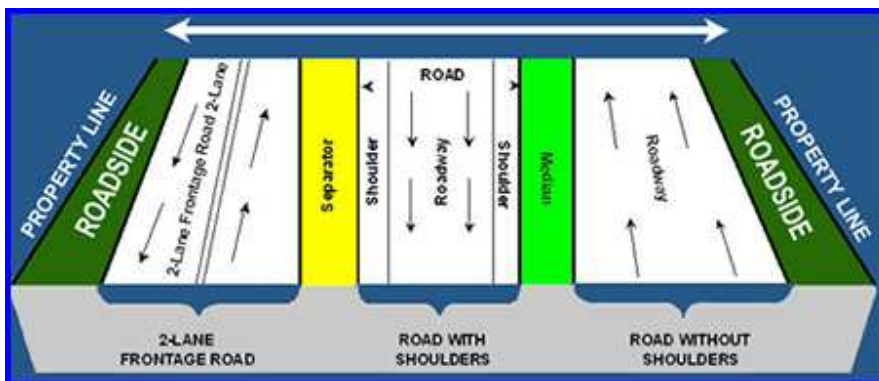

On Roadway: That part of the trafficway designed, improved, and ordinarily used for motor vehicle travel or, where various classes of motor vehicles are segregated, that part of a trafficway used by a particular class. Separate roadways may be provided for northbound and southbound traffic or for trucks and automobiles. Bridle paths, bicycle paths, and shoulders are not included in this definition.



Shoulder: That part of the trafficway contiguous with the roadway for emergency use, for accommodation of stopped motor vehicles, and for lateral support of the roadway structure.



Median: An area of the trafficway between parallel roads separating travel in opposite directions. A median should be four or more feet wide.



Roadside: From the property line of the outermost part of the trafficway to the edge of the first road.



Gore: An area of land where two roadways diverge or converge. The area is bounded on two sides by the edges of these roadways, which join at the point of divergence or convergence. The direction of traffic must be the same on both sides of the roadways. The area includes shoulders or marked pavement, if any, between the roadways.



Separator: A separator is the area of a trafficway between parallel roads separating travel in the same direction or separating a frontage road from other roads.



A separator may be a physical barrier or a depressed, raised, flush or vegetated area between roads.

In Parking lane or Zone (Not Parking Lot): Refers to a strip of road located on the roadway, or next to the roadway, on which parking is permitted. This includes curb-side and edge-of-roadway parking (for example, legal residential parking, city street parking, etc.). Sometimes a strip of roadway can be designated for parking at certain hours of the day and for regular travel at other hours. In that situation, this code would apply only during the hours when parking is permitted.



Parking Lot/ Off Roadway / Location Unknown: First harmful event is in a parking lot, off the roadway or location of first harmful event is unknown.

Outside right of way (trafficway): Not physically located on any land way open to the public as a matter of right or custom for moving persons or property from one place to another.

17 Damage Over Threshold

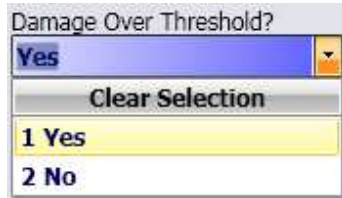

A screenshot of a software interface showing a dropdown menu titled "Damage Over Threshold?". The menu is currently set to "Yes". Below the dropdown is a "Clear Selection" button. The dropdown list is open, showing two options: "1 Yes" (highlighted in yellow) and "2 No".

Definition: Did the total dollar amount for this crash exceed the reporting threshold dollar amount (\$1000.00)?

- Damage estimates to vehicles should be based upon current fair market value to repair the vehicle regardless of vehicle age.
- Estimates should reflect the cost to bring a vehicle back to factory condition by a licensed body shop. The actual value of the vehicle should not be considered.
- Only damage received as a result of the crash being investigated should be considered for repair. Pre-existing damage prior to the crash should not be considered.
- The crash damage estimate should also include any property damaged as a result of the crash. This can include: Fencing, landscape damage, utility poles, regulatory signs, guardrails, etc.

18 Contributing Circumstances Environment 1 and 2

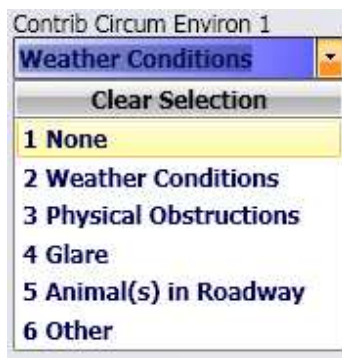

A screenshot of a software interface showing a dropdown menu titled "Contrib Circum Environ 1". The menu is currently set to "Weather Conditions". Below the dropdown is a "Clear Selection" button. The dropdown list is open, showing six options: "1 None", "2 Weather Conditions" (highlighted in yellow), "3 Physical Obstructions", "4 Glare", "5 Animal(s) in Roadway", and "6 Other".

Definition: Apparent environmental conditions which may have contributed to the crash.

Rationale: Important to determine existence of unusual conditions that could be useful in determining the need for additional traffic control devices or geometric improvements.

None: No environmental conditions were a contributing factor in the crash.

Weather Conditions: Indication that the environmental conditions recorded in Weather Conditions contributed to the crash.

Physical Obstructions: Refers to an object that blocked sight or diminished visibility and thus contributed to the crash (e.g. bush, tree, hillcrest, curve, embankment, building, etc.).

Glare: A situation where the angle of the sun greatly reduces visibility either from direct exposure or reflected light or the headlight exposure from another vehicle reduces visibility.

Animal(s) in Roadway: This would include live wild or domestic animals but would exclude animals pulling a conveyance or ridden animals.

Other: Only select “Other” if none of the other listed “contributing circumstance environment” descriptions are appropriate.

Contributing Circumstances Environment 2

Select this field if more than one contributing circumstance environment exists in the crash. The selections are the same as Contributing Circumstances Environment 1.

19 Contributing Circumstance Road 1 and 2

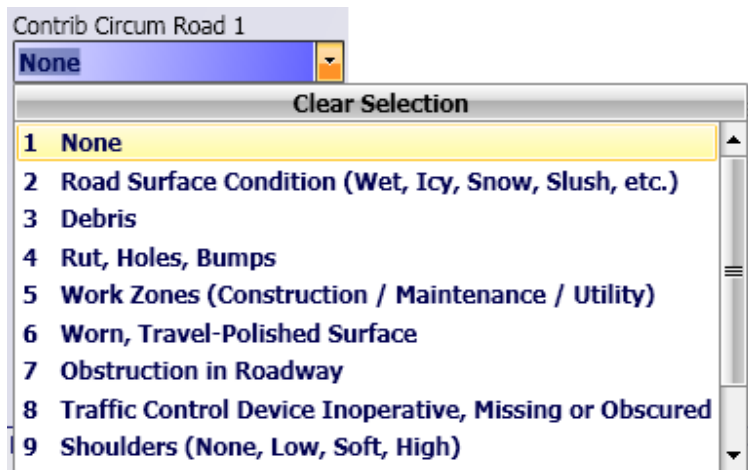

The image shows a screenshot of a software interface. At the top, there is a label 'Contrib Circum Road 1' and a dropdown menu currently displaying 'None'. Below the dropdown is a 'Clear Selection' button. A list of nine options is shown, with the first option '1 None' highlighted in yellow. The list items are: 1 None, 2 Road Surface Condition (Wet, Icy, Snow, Slush, etc.), 3 Debris, 4 Rut, Holes, Bumps, 5 Work Zones (Construction / Maintenance / Utility), 6 Worn, Travel-Polished Surface, 7 Obstruction in Roadway, 8 Traffic Control Device Inoperative, Missing or Obscured, and 9 Shoulders (None, Low, Soft, High).

Definition: Apparent condition of the road which may have contributed to the crash.

Rationale: Important to determine highway maintenance and possible engineering needs.

None: No roadway conditions were a contributing factor in the crash.

Road Surface Condition (wet, icy, snow, slush, etc): Indication that the road surface conditions recorded in Roadway Surface Condition contributed to the crash.

Debris: Objects in the roadway that are not large enough to block travel but could cause damage or a loss of control. Items such as dislodged cargo, parts from a vehicle, tire tread, broken glass, or animal carcasses.

Rut, Holes, Bumps: Would include any pavement irregularity such as missing grates, speed bumps, surface raised, depressed, or previously washed out, sinkholes.

Work Zone (Construction/ Maintenance / Utility): An area of a highway with construction, maintenance, or utility work activities. A work zone is typically marked by signs, channelizing devices, barriers, pavement markings, and/or work vehicles.

Worn, Traveled-Polished Surface: Where the road surface has lost the majority of its frictional value due to excessive wear. (Most used in motorcycle crashes)

Obstruction in Roadway: A blockage in the roadway. The object would be large enough to completely or partially block a travel lane and should, due to size or shape, be avoided. Items such as a fallen tree, boulder, or a trailer separated from its power unit or a vehicle(s) from a previous crash.

Traffic Control Device Inoperative, Missing or Obscured: This would include traffic control devices disabled or not functioning properly, lane markings faded or missing, signs that are down or covered by foliage, etc.

Shoulders (None, Low, Soft, High): Would include inadequate width, raised or not level shoulders.

Non-Highway Work: Maintenance or other types of work occurring near or in the trafficway but not related to the trafficway

Other: Only select “Other” if none of the other listed “contributing circumstance road” descriptions are appropriate.

Contributing Circumstance Road 2

Select this field if more than one contributing circumstance road exists in the crash. The selections are the same as Contributing Circumstances Road 1.

20

In or Near a Work Zone

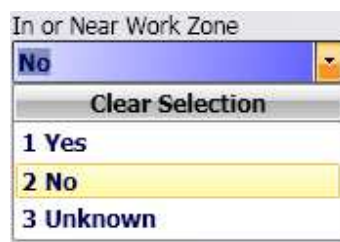

The image shows a software interface for a dropdown menu. The title of the menu is "In or Near Work Zone". The current selection is "No", which is highlighted in blue. Below the selection is a "Clear Selection" button. The menu also lists three other options: "1 Yes", "2 No", and "3 Unknown". The "2 No" option is currently highlighted in yellow.

Definition: A crash that occurs in or related to a construction, maintenance, or utility work zone, whether or not workers were actually present at the time of the crash. 'Work zone-related' crashes may also include those involving motor vehicles slowed or stopped because of the work zone, even if the first harmful event occurred before the first warning sign.

Rationale: Important to assess the impact on traffic safety of various types of on-highway work activity, to evaluate Traffic Control Plans used at work zones, and to make adjustments to the Traffic Control Plans for the safety of workers and the traveling public. This data element needs to be collected at the scene because work zones are relatively short term or moving operations that are not recorded in permanent road inventory files.

Work Zone: A work zone is an area of a trafficway where construction, maintenance, or utility work activities are identified by warning signs/signals/indicators, including those on transport devices (e.g., signs, flashing lights, channelizing devices, barriers, pavement markings, flagmen, warning signs and arrow boards mounted on the vehicles in a mobile maintenance activity) that mark the beginning and end of a construction, maintenance or utility work activity.



It extends from the first warning sign, signal or flashing lights to the END ROAD WORK sign or the last traffic control device pertinent for that work activity.

Work zones also include roadway sections where there is ongoing, moving (mobile) work activity such as lane line painting or roadside mowing only if the beginning of the ongoing, moving (mobile) work activity is designated by warning signs or signals.



Work Zone Crash: A traffic crash in which the first harmful event occurs within the boundaries of a work zone or on an approach to or exit from a work zone, resulting from an activity, behavior or control related to the movement of the traffic units through the work zone. Includes collision and non-collision crashes occurring within the signs or markings indicating a work zone

or occurring on approach to, exiting from or adjacent to work zones that are related to the work zone.

Example 1: An automobile on the roadway loses control within a work zone due to a shift or reduction in the travel lanes and crashes into another vehicle in the work zone.

Example 2: A van in an open travel lane strikes a highway worker in the work zone.

Example 3: A highway construction vehicle working on the edge of the roadway is struck by a motor vehicle in transport in a construction zone.

Example 4: A rear-end crash occurs before the signs or markings indicating a work zone due to vehicles slowing or stopped on the roadway because of the work zone activity.

Example 5: A pickup in transport loses control in an open travel lane within a work zone due to a shift or reduction in the travel lanes and crashes into another vehicle which exited the work zone.

Example 6: A tractor-trailer approaching an intersection where the other roadway has a work zone strikes a pedestrian outside the work zone because of lack of visibility caused by the work zone equipment.

Exclusions: Single-vehicle crashes involving working vehicles not located in trafficway.

Example 1: A highway maintenance truck strikes a highway worker inside the work site.

Example 2: A utility worker repairing the electrical lines over the trafficway falls from the bucket of a cherry picker.

Example 3: Private construction, maintenance or utility work outside the trafficway. For example, a building being constructed or the lines being painted for a business' parking lot stalls.

21 Work Zone Workers Present

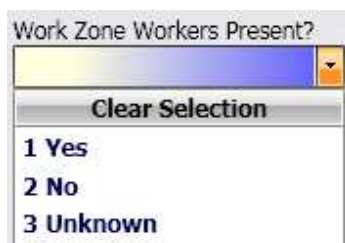

Work Zone Workers Present?

Clear Selection

- 1 Yes
- 2 No
- 3 Unknown

Were work zone workers present at the time of the crash? **This does not include Law Enforcement.**

Location Related to Work Zone

Loc Related to Work Zone?

Clear Selection

- 1 Before the First Work Zone Warning Sign
- 2 Advance Warning Area
- 3 Transition Area
- 4 Activity Area
- 5 Termination Area

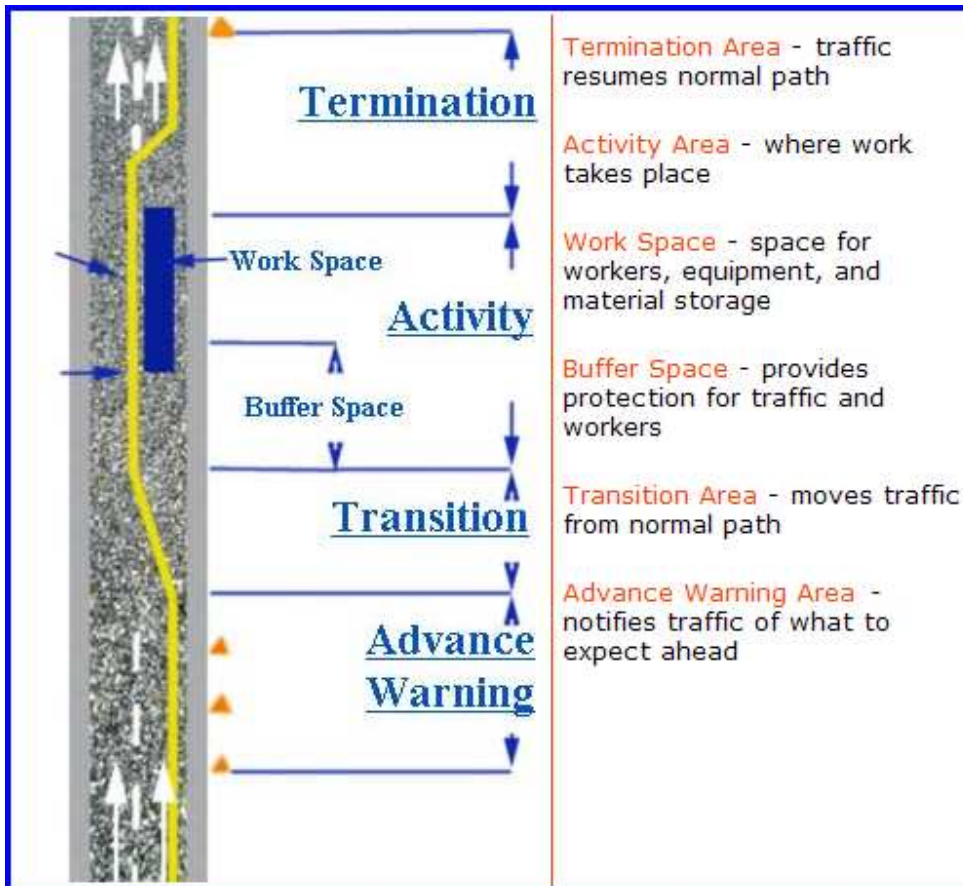

Before First Work Zone Warning Sign: This would be if the crash occurred outside a work zone, but it was a result of traffic backed up from a work zone.

Advance Warning Area: Area notifying traffic of what to expect ahead.



Transition Area: Moves traffic from normal path.



Activity Area: Where work takes place.



Termination Area: Traffic resumes normal path.



23 **Type of Work Zone**

Type of Work Zone

Clear Selection

- 1 Lane Closure
- 2 Lane Shift/Crossover
- 3 Work on Shoulder or Median
- 4 Intermittent or Moving Work
- 5 Other

Lane Closure: A travel lane is completely blocked.



Lane Shift/Crossover: Traffic is forced to merge to an adjacent or opposing lane.



Work on Shoulder or Median: Work is being done off travel portion of the roadway, but a portion of the travel lane is blocked.



Intermittent or Moving Work: The work zone location is not fixed and is constantly moving (lane marking, pothole repair, mowing etc).



Other: Only select “Other” if none of the other listed “type of work zone” descriptions are appropriate.

Practical Example 1: The unstabilized situation begins on a portion of the trafficway open to the public and the first event occurs in the construction area closed by barricades or cones.

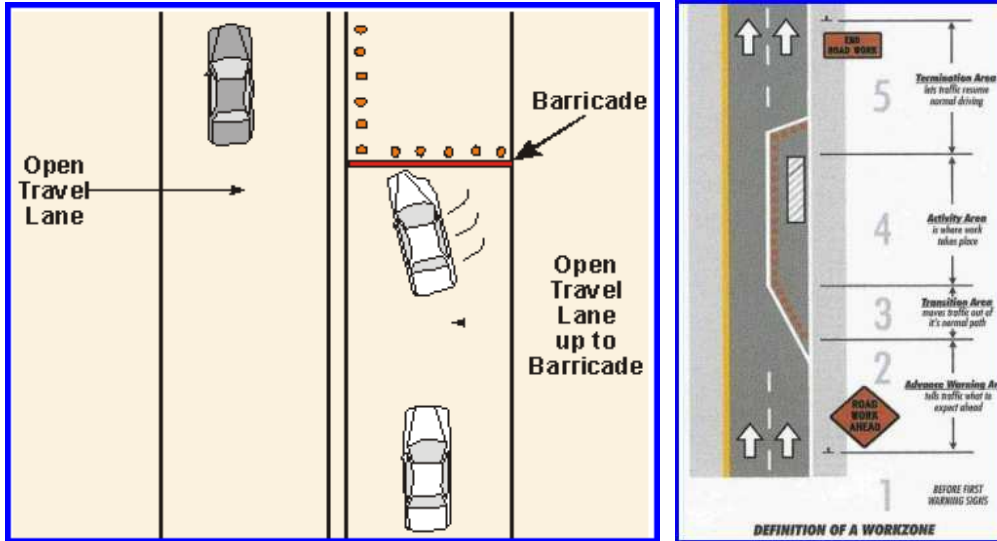

Motor Vehicle Crash? YES

Work Zone Crash? YES

Location? Activity Area

Type? Lane Closure

Practical Example 2: An unstabilized situation begins on a portion of the trafficway open to the public and the first event occurs in a construction area closed by barricades or cones.

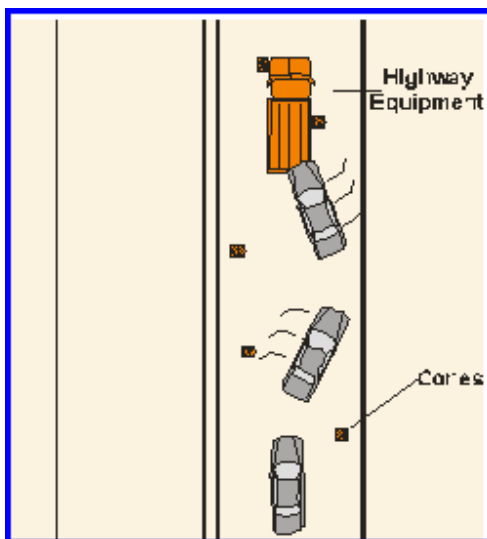

Motor Vehicle Crash? YES

Work Zone Crash? YES

Location? Activity Area

Type? Lane Closure

Practical Example 3:

An unstabilized situation begins on a portion of the trafficway closed to public due to construction and the first event occurs in the construction area closed by barricades or cones.

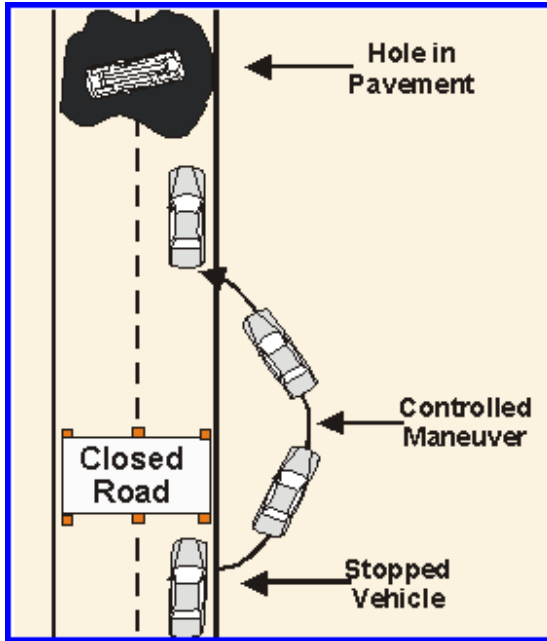

Motor Vehicle Crash? NO

Work Zone Crash? NO

Location? Not Applicable

Type? Not Applicable

24 Police Present at Work Zone

Police Present at Work Zone?

Clear Selection

1 Yes
2 No
3 Unknown

Was a police officer present at the work zone? (Not specifically the crash area).

25 School Bus Related

School Bus Related?

Yes, School Bus Directly

Clear Selection

1 Yes, School Bus Directly Involved
2 Yes, School Bus Indirectly Involved
3 No

Definition: Indicates if a school bus or motor vehicle functioning as a school bus for a school-related purpose is involved in the crash. The school bus, with or without a passenger on board, must be directly involved as a contact motor vehicle or indirectly involved as a non-contact motor vehicle (children struck when boarding or exiting a school bus, two vehicles colliding as a result of the stopped school bus, etc.)

Rationale: Important in determining where and how school children are at the greatest risk of injury when being transported by school bus and the extent to which school bus operations affect overall traffic safety.

School Bus Defined: A motor vehicle used for the transportation of any school pupil at or below the 12th-grade level to or from a public or private school or school-related activity. A motor vehicle is not a school bus while on trips which involve the transportation exclusively of other passengers or exclusively for other purposes.



Maine Title 29-A definitions:

School bus CMV: "School bus CMV" means a commercial motor vehicle used to transport preprimary, primary or secondary school students from home to school, from school to home or to and from school-sponsored events. "School bus CMV" does not include a bus used as a common carrier or a private school activity bus.

School bus non-CMV: "School bus non-CMV" means a noncommercial motor vehicle designed to carry more than 10 passengers, including the driver, but less than 16 passengers, including the driver, and used to transport students from home to school, from school to home or to and from school-related events. "School bus non-CMV" does not include a private motor vehicle used to transport members of the owner's household or a private school activity bus.

Includes: (Yes)

1. A collision involving a motor vehicle in transport in which one or more school buses strike(s) or are (is) struck by another road vehicle (directly involved).
2. A collision or non-collision event involving a motor vehicle in transport passing a school bus, stopped and with its red lights flashing. (The school bus is a non-contact vehicle indirectly involved.)

Excludes: (No)

1. A collision or non-collision event involving a motor vehicle which is normally used as a school bus, but is carrying only senior citizens when the collision occurs.

Example 1:

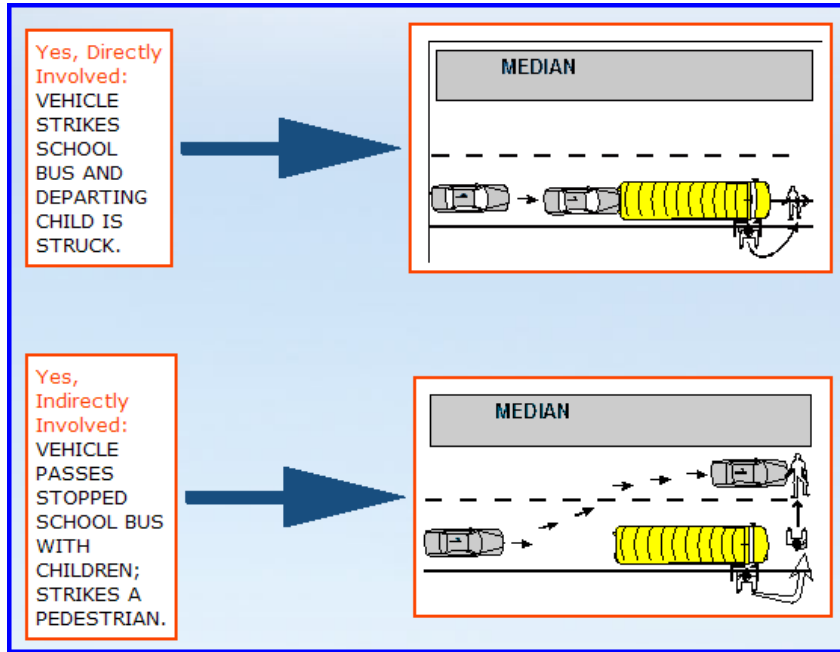

Example 2:

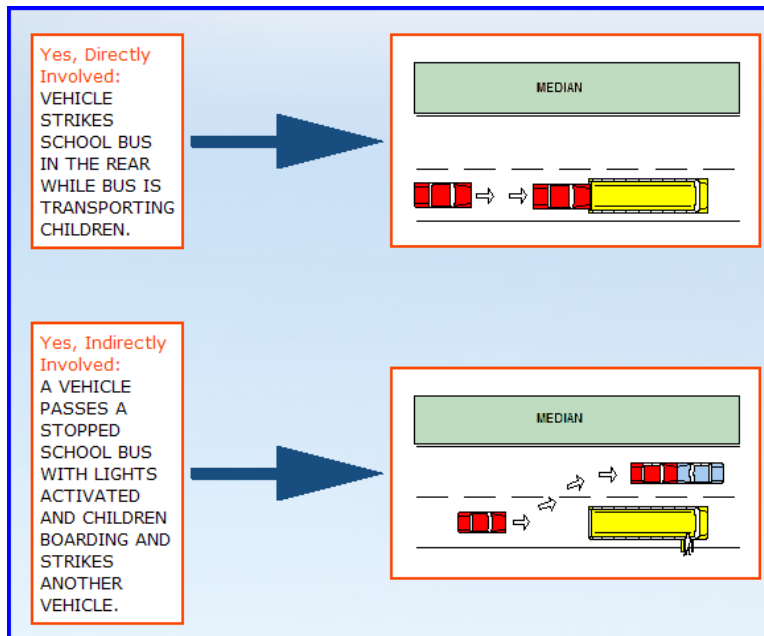

Example 3:

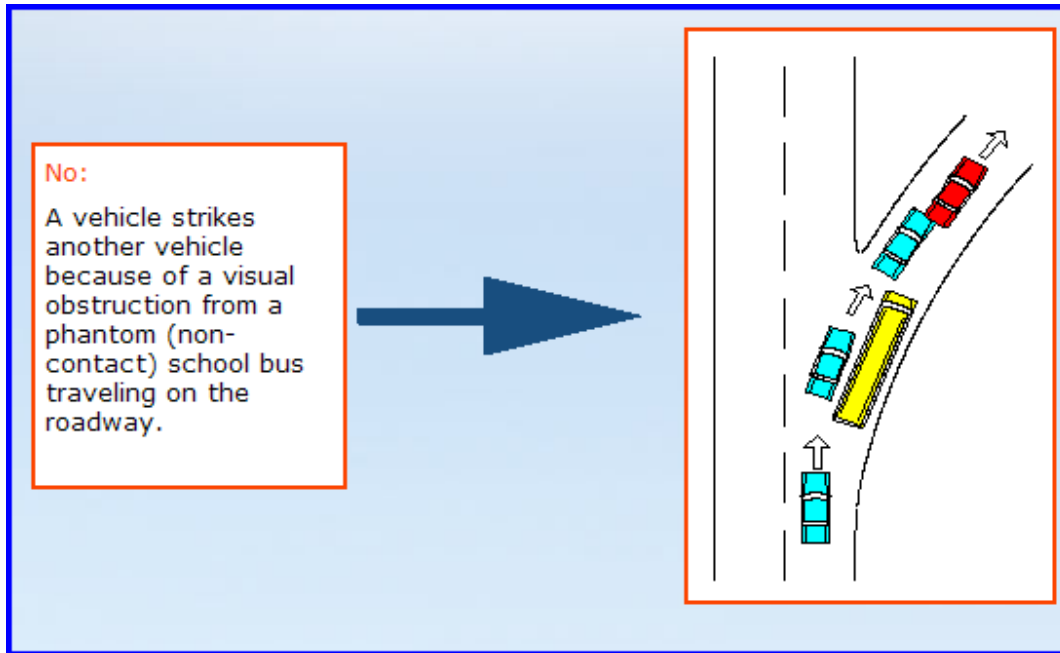

Reporting Officer and Approval

The reporting officer and approval section contains the investigating officer's name, badge or officer number, the crash report completion date, comment section for supervisors, approving officer, and approval date.

Officer Name

The name and rank of officer investigating and completing the crash report.

Reporting Officer Name

This field is permanently set by the administrator for each department and will be populated when the officer logs onto the system.

Badge Number

The investigating Officer's badge number or Officer number.

Badge #

26 Report Date

The date the report is completed.

A screenshot of a web form field labeled "Report Date". The field contains the date "6/8/2010" and has a small calendar icon to its right.

Add Comment

This field enables a supervisor to add a comment to a report that is being returned for corrections or changes.

A screenshot of a button labeled "Add Comment" with a yellow plus sign icon to its right.

27 Approved By

This field is completed by the reviewing supervisor of the officer.

It is imperative the reviewer not only ensures the crash report is complete but also verifies the crash coding is correct and all diagrams and descriptions correspond with the appropriate coding.

To be affective at pinpointing safety problems and leverage funding to address needed safety improvements it is imperative the reviewing supervisor/officer verify accurate coding, crash location, crash diagrams and descriptions.

Approved Date

The date the crash report is approved

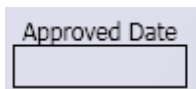
A screenshot of a web form field labeled "Approved Date". The field is currently empty.

This is auto-filled at the time of approval.

86 Narrative

Write a brief but concise description of the events of the crash. This description is to be based on facts, conclusions, and opinions of the investigating officer. Description should explain the reason behind contributing factor coding.

Officer Notes

This section may be used to make note of facts in the crash that are not recorded in the crash report, such as telephone numbers, field sobriety test notes etc. These notes will not be printed with the crash report.

Unit Elements

Identifies each unit in terms of make, model, color, vehicle configuration, GVWR, any special functions, vehicle actions and sequence of events.

Unit Identification

The MCRS software automatically assigns a unit number to each unit involved in the crash in order of unit information entered.

Hit and Run

Hit Run?

Select Hit and Run when one of the units involved has left the scene and complete unit and person information is not available. If, at a later date the information is recovered, the investigating officer can enter the data and resubmit the crash report.

28 Unit Type

Definition: The category indicating the general configuration or shape of a motor vehicle distinguished by characteristics such as number of doors, rows of seats, windows, or roof line.

Rationale: Important to identify the specific type of motor vehicle involved in the crash for evaluation and comparison purposes.



Passenger Car: Motor vehicles used primarily for carrying passengers.

Automobile (from ANSI D-16.1): An automobile is a motor vehicle other than a motorcycle, utility vehicle or low speed vehicle consisting of a transport device typically designed for carrying eight or fewer persons.

Passenger Car Body Types:

Convertible (excludes sun-roof, t-bar)

2-door sedan, hardtop, coupe

3-door/2-door hatchback

4-door sedan, hardtop

5-door/4-door hatchback

Station wagon (excluding van and truck based)

Automobile Derivatives:

Auto-based pickup (includes El Camino, Caballero, Ranchero, Chevrolet - SSR; Subaru - Brat, Baha; Volkswagen - Rabbit Pickup)

Auto-based panel (cargo station wagon, auto-based ambulance or hearse)

Large limousine - more than four side doors or stretch chassis.

Three-wheel automobile or automobile derivative.

(Sport) Utility Vehicle (from ANSI D-16.1): A utility vehicle is a motor vehicle other than a motorcycle or large bus consisting primarily of a transport device designed for carrying persons, and generally considered a multi-purpose vehicle that is designed to have off-road capabilities. These vehicles are generally four-wheel-drive (4 x 4) and have increased ground clearance. A utility vehicle typically has a gross vehicle weight rating (GVWR) of 10,000 pounds or less.



Sport Utility Vehicle Examples:

Small: GMC Jimmy

Midsized: Jeep Cherokee

Full Size: Chevy Suburban

Large: Hummer

Passenger Van: A van body style that is configured to carry people.

Clarification: Van (from ANSI D-16.1): A van is a motor vehicle consisting primarily of a transport device which has a gross vehicle weight rating (GVWR) of 10,000 pounds or less and is basically a “box on wheels” that is identifiable by its enclosed passenger and/or cargo area, step-up floor, and relatively short (or non-existent) hood.

Clarification: Passenger Van (from ANSI D-16.1): A passenger van is any van where the area behind the driver or cab is designed for carrying passengers.

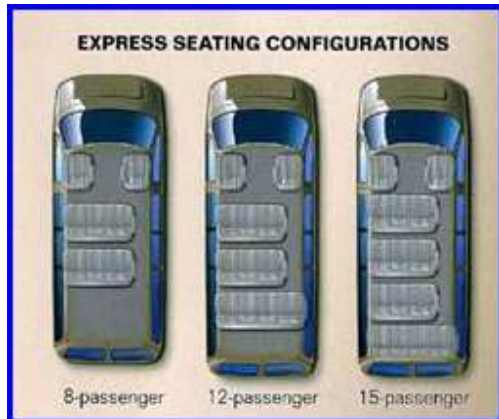

Cargo Van (10, 000 lbs. or less): A cargo van is any van where the area behind the driver or cab is designed for transporting cargo or operated for general commercial use.



Important Note - Vans with a GVWR greater than 10,000 lbs. would be classified as Medium/Heavy Trucks (see attribute list).

Pickups: Any utility vehicle identifiable by a body style consisting of an open cargo area bed behind the cab.

Motor Home: A van where a frame-mounted recreational unit is added behind the driver or cab area or mounted on a bus/truck chassis that is suitable to live in and drive across the country.



School Bus: Examples of this body style include full size and van-based school bus configurations (see photos below). Also included are those without the standard school bus color and markings but still having this configuration. (e.g. a full size school bus painted blue and used by a church.)



Transit Bus: A government entity or private company providing passenger transportation over fixed, scheduled routes, within primarily urban geographical areas. (For example; inner-city mass transit bus service.) A transit bus is designed for public transportation typically within a city.



Motor Coach: A company providing for-hire, long-distance passenger transportation between cities over fixed routes with regular schedules (for example; Greyhound bus service between major cities).

Other Bus: A vehicle designed/converted to carry eight or more people with a body type other than that of a school bus, motor coach, or transit bus. Includes vehicles such as: Vans specially configured as bus body type such as; Cab-chassis seating greater than 8 people, specially configured buses (tour buses).



Motorcycle: A two- or three-wheeled motor vehicle designed to transport one or two people, has a seat or a saddle for the use of the rider and is designed to travel with only 2 or 3 10-inch or larger diameter wheels in ground contact and has a motor with a cylinder capacity of more than 50 cubic centimeters or an electric motor with a capacity of not less than 1,500 watts.



Moped: (from ANSI D-16.1) a speed-limited motor-driven cycle (motorcycle) which may be propelled by pedaling.

"Moped" (from Title 29-A) means a motorized device designed to travel with only 2 or 3 10-inch or larger diameter wheels in contact with the ground and that:

- A. May have fully operative pedals for propulsion by human power;
- B. Has an electric or a liquid fuel motor with a cylinder capacity displacement not exceeding 50 cubic centimeters or an electric motor with a capacity under 1,500 watts; and



- C. Is equipped with a power drive system that functions only directly or automatically and does not require clutching or shifting by the operator after the drive system is engaged.

Low Speed Vehicle: A low speed vehicle (LSV) is a motor vehicle with four or more wheels whose top speed is greater than 20 miles per hour, but not greater than 25 miles per hour and is less than 3,000 pounds in unloaded weight. LSV's are required to be equipped with basic items of safety equipment: headlamps, stop lamps, turn signal lamps, tail lamps, reflex reflectors, parking brake, windshields of either type AS-1 or type AS-5 glazing, rearview mirrors, seat belts and vehicle identification numbers (VINs).

LSV does not include an ATV as defined in Title 12, section 13001. A low-speed vehicle must be originally manufactured and maintained in accordance with the Federal Motor Vehicle Safety Standards as a low-speed vehicle pursuant to 49 Code of Federal Regulations, Section 571.500, as amended.



Low Speed Vehicle (from NHTSA) - a vehicle having a top speed of 20 to 25 mph. Any golf cart or other four-wheeled motorized vehicle with a top speed in that range qualifies for the class.

Excluded from Low Speed Vehicle are Pedestrian Conveyances such as: Motorized wheelchairs, motorized skateboards, motorized handicapped scooters, and personal devices such as the Segway.

Autocycle: "Autocycle" means an enclosed motorcycle having no more than 3 wheels in contact with the ground and that:

- A. Meets the general motorcycle inspection standards, except those standards that do not apply due to the design of the vehicle; and
- B. Is equipped with:
 - (1) Safety belts for all passengers;
 - (2) A roll bar or enclosed cab;
 - (3) A steering wheel or tiller; and

(4) Brakes on at least 2 main wheels.

The manufacturer's certificate of origin must state that the vehicle meets the federal specifications for a motorcycle.



Experimental Vehicle: "Experimental motor vehicle" means any motor vehicle in the developmental stage that has not yet reached production.

Other Light Trucks (10,000 lbs or less): Trucks that are 10,000 lbs. or less.

Important Note: This does not include Sport Utility Vehicles, Vans (Passenger/Cargo), or Pickups.

Medium/Heavy Trucks (More than 10,000 lbs): Trucks greater than 10,000 lbs. (GVWR of the Single Unit Truck and the Power Unit of Single Unit Truck pulling a trailer (Truck/Trailer)

ATV (2, 3, and 4 Wheel): "All-terrain vehicle" or "ATV" means a motor-driven, off-road, recreational vehicle capable of cross-country travel on land, snow, ice, marsh, swampland or other natural terrain. "All-terrain vehicle" or "ATV" includes, but is not limited to, a multitrack, multiwheel or low-pressure tire vehicle; a motorcycle or related 2-wheel, 3-wheel or belt-driven vehicle; an amphibious machine; or other means of transportation deriving motive power from a source other than muscle or wind. "All-terrain vehicle" or "ATV" does not include an automobile as defined in Title 29-A, section 101, subsection 7; an electric personal assistive mobility device as defined in Title 29-A, section 101, subsection 22-A; a truck as defined in Title 29-A, section 101, subsection 88; a snowmobile; an airmobile; a construction or logging vehicle used in performance of its common functions; a farm vehicle used for farming purposes; or a vehicle used exclusively for emergency, military, law enforcement or fire control purposes.



Snowmobile: "Snowmobile" means a vehicle propelled by mechanical power that is primarily designed to travel over ice or snow and is supported in part by skis, belts or cleats.

Other: Only select "Other" if none of the other listed "Unit Type" descriptions are appropriate.



29 Motor Vehicle Identification Number (VIN)

VIN

1B3EL46X36N239970

Definition: A unique combination of alphanumeric or numeric characters assigned to a specific motor vehicle that is designated by the manufacturer.

Rationale: Important to identify specific motor vehicle design characteristics and occupant protection systems for effectiveness evaluations.

Enter the VIN from the vehicle, usually available from the driver's side dashboard near the windshield. The VIN should have 17 alphanumeric characters for vehicles manufactured after 1980. Do NOT copy the VIN from the vehicle registration; typographical errors may exist, or the plates may be on the wrong vehicle.

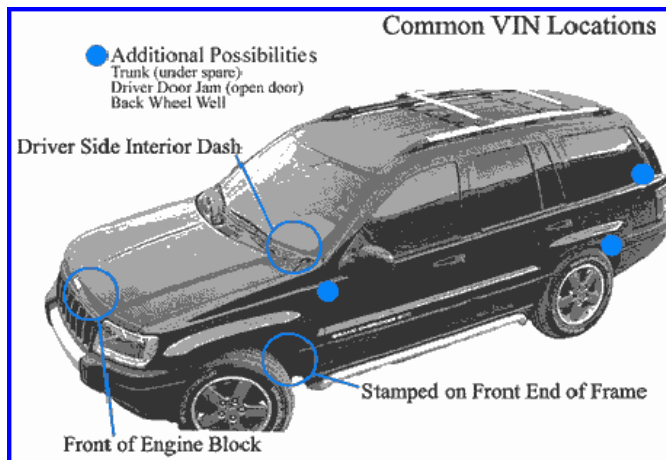

License Plate

License Plate

4321BR

Definition: The alphanumeric identifier or other characters, exactly as displayed, on the registration plate or tag affixed to the motor vehicle. For combination trucks, motor vehicle plate number is obtained from the power unit or tractor.

Rationale: Critical for linkage between the crash and motor vehicle registration files.

State

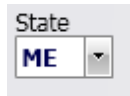

A dropdown menu labeled "State" with "ME" selected.

Definition: The state, commonwealth, territory, Indian Nation, U.S. Government, foreign country, etc., issuing the registration plate displayed on the motor vehicle. For foreign countries, MMUCC requires only the name of the country. Border states may want to collect the name of individual Canadian provinces or Mexican states.

Rationale: This element is critical in providing linkage between the crash and motor vehicle registration files to access the motor vehicle identification number.

Vehicle Information

Vehicle Make

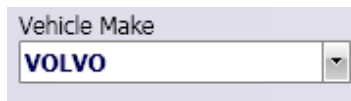

A dropdown menu labeled "Vehicle Make" with "VOLVO" selected.

Definition: The distinctive (coded) name applied to a group of motor vehicles by a manufacturer.

Rationale: Important for use in identifying motor vehicle make, for evaluation, research and crash comparison purposes.

Select a "make" option from the drop-down menu or utilize the type-ahead feature.

Vehicle Year



A dropdown menu labeled "Veh Year" with "2006" selected.

Enter the manufacturer year of the vehicle.

Vehicle Color

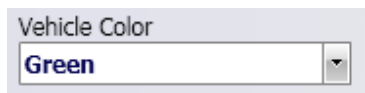

A dropdown menu labeled "Vehicle Color" with "Green" selected.

Select the appropriate color from the drop-down menu or utilize the type-ahead feature. **NOTE:** Vehicles that have multiple colors should have the major body color selected.

Insurance

No Insurance (check box)

Only select this check box when it cannot be confirmed the operator or owner of the vehicle has motor vehicle insurance.

30 NAIC number (National Association of Insurance Commissioners)

NAIC
22063

The NAIC is the organization of state insurance regulators for all 50 of the United States, Washington DC, and five US territories.

Many Insurance companies publish a 5-digit identification number located on insurance information cards issued to clients.

GEICO geico.com Maine Motor Vehicle Insurance Identification Card
GOVERNMENT EMPLOYEES INSURANCE COMPANY
300 Crosspoint Parkway • Getzville, NY 14068 1-800-841-3000
NAIC Code: 22063
Policy Number: 2017-18-82-73 Effective Date: 02-14-10 Expiration Date: 08-14-10
Year: 2000 Make: NEONHGH/ES Model: NEONHGH/ES Vehicle ID No.: 1B3ES46C0YDA51102
Insured: John Doe
The coverage provided by this policy meets the minimum liability limits prescribed by law.
This card should be kept in the insured motor vehicle and presented on the demand of a law enforcement officer.

If an NAIC number is available, entering this number will automatically populate the company name field.

Insurance Company Name

Insurance Company Name
Geico

GEICO geico.com Maine Motor Vehicle Insurance Identification Card
GOVERNMENT EMPLOYEES INSURANCE COMPANY
300 Crosspoint Parkway • Getzville, NY 14068 1-800-841-3000
NAIC Code: 22063
Policy Number: 2017-18-82-73 Effective Date: 02-14-10 Expiration Date: 08-14-10
Year: 2000 Make: NEONHGH/ES Model: NEONHGH/ES Vehicle ID No.: 1B3ES46C0YDA51102
Insured: John Doe
The coverage provided by this policy meets the minimum liability limits prescribed by law.
This card should be kept in the insured motor vehicle and presented on the demand of a law enforcement officer.

Enter the name of the insurance company providing the insurance NOT the local carrier or agent.

Policy Number

Insurance Policy Number

2017-18-82-73



GEICO geico.com Maine Motor Vehicle Insurance Identification Card
GOVERNMENT EMPLOYEES INSURANCE COMPANY
300 Crosspoint Parkway • Getzville, NY 14068 1-800-841-3000
NAJC Code: 22063
Policy Number: 2017-18-82-73 Effective Date: 02-14-10 Expiration Date: 08-14-10
Year: 2000 Make: NEON Model: NEONHG/ES Vehicle ID No.: 1B3ES46C0YDA51102
Insured:
John Doe
The coverage provided by this policy meets the minimum liability limits prescribed by law.
This card should be kept in the insured motor vehicle and presented on the demand of a law enforcement officer.

Enter the policy number listed on the insurance information card that is assigned to the vehicle involved in the crash.

31 Exempt Vehicle



Exempt Vehicle
No
Clear Selection
1 Yes
2 No

Maine Statute Title 24-A Chapter 23 §2174-A and B (The Insurance Code Involving Public Works Vehicles and Police Vehicles) exempts public works employees and police vehicle operators from increases in personal insurance premiums when:

- A. The crash occurred while the employee or officer was operating a motor vehicle in the course and scope of employment; and
- B. There is a policy of insurance other than the personal insurance policy providing motor vehicle liability or collision coverage for the accident or accidents.

Definitions: For the purposes of this section, "*public works employee*" means a government employee, as defined by Title 14, section 8102, subsection 1, whose employment involves the care, maintenance or construction of municipally or state-owned buildings, open space, parks, parking facilities, waste water treatment systems, sewers or other property, roads, highways or other public ways. For purposes of this section, "public works employee" also includes an individual who is an independent contractor or employee of an independent contractor, under contract to the governmental entity and whose employment involves the functions listed in this subsection.

"Law enforcement officer" means any person employed by a governmental entity who by virtue of that employment is vested by law with a duty to investigate and prosecute violators of the laws of this State and to arrest the offenders of the laws.

Large Vehicle Information

This section aids in determining if Federal Motor Carrier Safety Administration (FMCSA) selection criteria for FMCSA reportable crashes are met. If the FMCSA criteria are met the Commercial Vehicle Information section will be activated.

32 Hazmat Placarded

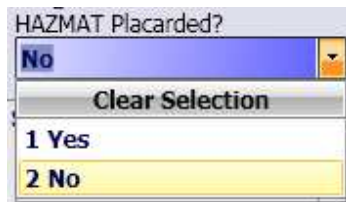

The screenshot shows a dropdown menu titled "HAZMAT Placarded?". The current selection is "No". Below the dropdown is a "Clear Selection" button. The menu is open, showing two options: "1 Yes" and "2 No".

Select **yes** if a vehicle involved in the crash is displaying a hazardous materials placard, regardless of weight.

Note: If a vehicle is discovered to be transporting hazardous materials without a required placard by an officer knowledgeable in Federal Hazardous Materials Regulations, it should also be reported to FMCSA.

33 Vehicle configuration

Definition: Indicates the general configuration of this motor vehicle.

Rationale: (required by the Federal Motor Carrier Safety Administration CFR 350.201.) This data element provides information about the general configuration of the motor vehicle that is important to evaluate the types of motor vehicles that have the most crashes and the effectiveness of various safety countermeasures. This data element is collected at the scene because FMCSA requires reporting within 90 days.

Note: This field is only activated if Unit type is checked as medium/heavy vehicles (more than 10,000 lbs) or Hazmat Placarded is checked "Yes."

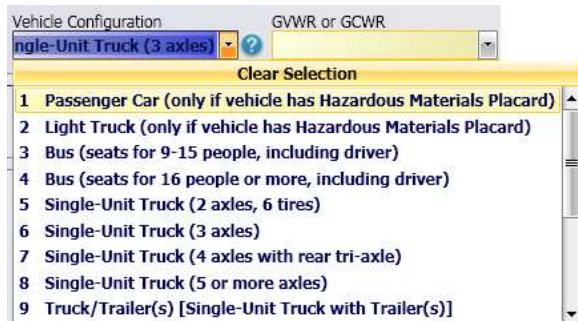

The screenshot shows a dropdown menu titled "Vehicle Configuration". The current selection is "Single-Unit Truck (3 axles)". Below the dropdown is a "Clear Selection" button. The menu is open, showing a list of options:

- 1 Passenger Car (only if vehicle has Hazardous Materials Placard)
- 2 Light Truck (only if vehicle has Hazardous Materials Placard)
- 3 Bus (seats for 9-15 people, including driver)
- 4 Bus (seats for 16 people or more, including driver)
- 5 Single-Unit Truck (2 axles, 6 tires)
- 6 Single-Unit Truck (3 axles)
- 7 Single-Unit Truck (4 axles with rear tri-axle)
- 8 Single-Unit Truck (5 or more axles)
- 9 Truck/Trailer(s) [Single-Unit Truck with Trailer(s)]

Passenger Car (only if vehicle has Hazardous Materials Placard): Vehicle 10,000 pounds or less placarded for hazardous materials ' this attribute would include the passenger car, light truck (cargo van, mini-van, utility truck, panel truck, pickup truck 10,000 lbs. or less GVWR), sport utility vehicle, motorcycle, motor home.

Light Truck(only if has Hazardous Material Placard): Vehicle 10,000 pounds or less placarded for hazardous materials ' this attribute would include the passenger car, light truck (cargo van, mini-van, utility truck, panel truck, pickup truck 10,000 lbs. or less GVWR), sport utility vehicle, motorcycle, motor home.

Bus (seats of 9-15 people, including driver): See Unit type Van and Bus descriptions.

Bus (seats for 16 or more passengers, including driver): See Unit type Van and Bus descriptions.

Single-Unit Truck (2 axles, 6 tires): A power unit that includes a permanently mounted cargo body (also called a straight truck) that has only two axles and a GVWR of over 10,000 lbs.



Single-Unit Truck (3 axles): A power unit that includes a permanently mounted cargo body (also called a straight truck) that has three axles.



Single-Unit Truck (4 axles with rear tri-axle): A power unit that includes a permanently mounted cargo body (also called a straight truck) that has four axles.



Single-Unit Truck (5 or more axles): A power unit that includes a permanently mounted cargo body (also called a straight truck) that has five axles.



Truck/Trailer(s) [Single-Unit Truck with Trailer(s)]: A motor vehicle combination consisting of a single-unit truck and a trailer. **Note:** This attribute is **not** to be used for a Truck Tractor (Bobtail) pulling a trailer, see Truck Tractor/Semi-trailer or vehicles towing other vehicles.



Truck Tractor (without trailer, bobtail or saddle mount): A motor vehicle consisting of a single motorized transport device designed primarily for pulling semi-trailers.



In the below photos examples of a truck tractors (bobtails) towing other vehicles, it is important that these are not recorded as truck trailers or truck tractor semi-trailers. (See Towing vs. Trailing)



Towing vs. Trailing: (From the FARS Coding Manual): A vehicle towing another 'motor vehicle' is NOT considered to be a 'trailer' but is considered to be a 'towed vehicle'. An example would be a bobtail towing one or more other bobtails (Saddleback Mount). A vehicle towing another motor vehicle(s) is where the towed vehicle has two or more wheels on the ground. Towing does not apply to vehicles loaded on a flatbed trailer.

Tractor/Semi-Trailer (one trailer - 5 axles): A single unit truck tractor that is pulling a semi-trailer. Total axle count for tractor/semi trailer is five axles.



Tractor/Semi-Trailer (one trailer - 6 axles): A single unit truck tractor that is pulling a semi-trailer. Total axle count for tractor/semi trailer is six axles.



Tractor/Semi-Trailer (one trailer - All other axle configurations): A single unit truck tractor that is pulling a semi-trailer. Total axle count for tractor/semi trailer is more than six axles.

Tractor/Doubles (two trailers): A truck tractor that is pulling a single semi-trailer and one full trailer.



Tractor/Triples (three trailers): A truck tractor that is pulling a single semi-trailer and two full trailers.



Other Truck Greater Than 10,000 lbs. (not listed above): this attribute would apply to vehicles that do not fit into any other category. Typically, this would be farm equipment or heavy machinery and would be classified as 'Other' or 'No Cargo Body' in Cargo Body Type.



34 **GVWR (Gross Vehicle Weight Rating) or GCWR (Cross Combined Weight Rating)**

GVWR or GCWR	▼
Clear Selection	
1 10,000 lbs. or less	
2 10,001 - 26,000 lbs.	
3 Greater than 26,000 lbs.	

Definition:

The Gross Vehicle Weight Rating (GVWR) is the amount recommended by the manufacturer as the upper limit to the operational weight for a motor vehicle and any cargo (human or other) to be carried.

The Gross Combination Weight Rating (GCWR) is the sum of all GVWRs for each unit in a combination-unit motor vehicle. Thus, for single-unit trucks there is no difference between the GVWR and the GCWR. For combination trucks (truck tractors pulling a single semi-trailer, truck tractors pulling double or triple trailers, trucks pulling trailers, and trucks pulling other motor vehicles) the GCWR is the total of the GVWRs of all units in the combination. (See Example).



GVWR and GCWR are manufacturer designated weight ratings, not the loaded weights from the bill of lading or the scaled weight of the vehicle.

Rationale: (Required by the Federal Motor Carrier Safety Administration CFR 350.201.) The Federal Motor Carrier Safety Administration (FMCSA) imposes certain regulations on all single or combination-unit trucks that have a Gross Combination Weight Rating (GCWR) of more than 10,000 lbs. Additional regulations are imposed on all motor vehicles with GCWRs of more than 26,000 lbs. This data element is collected at the scene because FMCSA requires reporting within 90 days.



The above pickup would qualify under the FMCSA guidelines by weight only if used in combination with a trailer of sufficient size to make its GCWR in excess of 10,000 lbs., as in the photo above. It would then only be included if owned and operated primarily for commercial purposes and not for personal use. (Please see Selection Criteria) If a qualifying vehicle, in this element it would be recorded with a GCWR of 10,001-26,000 lbs.

35

9 or More seats

9 or More Seats?	
No	▼
Clear Selection	
1	Yes
2	No
3	Unknown

Definition: This element describes the common type of bus service this vehicle was being used as at the time of the crash. Buses are any motor vehicle with seats to transport nine (9) or more people, including the driver's seat. **Note:** This element does not include vans which are owned and operated for personal use.

Rationale: This data element provides additional information to evaluate the outcome of motor vehicles used as buses that are involved in crashes.

Special Function Vehicle

Definition: The type of special function being served by this vehicle regardless of whether the function is marked on the vehicle.

Rationale: Important to evaluate the outcome of vehicles used for special uses that are involved in crashes.

36 Special Function Vehicle

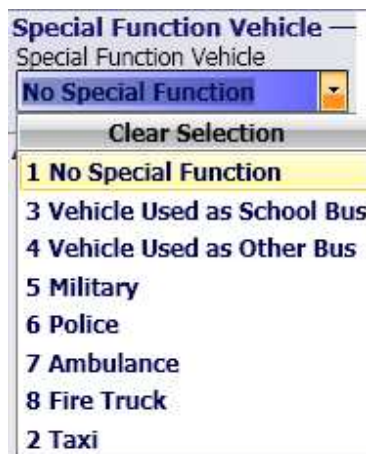

The image shows a screenshot of a software interface. At the top, there is a title bar that says "Special Function Vehicle". Below the title bar, there is a text field containing "Special Function Vehicle". Below the text field is a dropdown menu. The dropdown menu is currently open, showing a list of options. The first option is "No Special Function", which is highlighted in blue. Below this option is a "Clear Selection" button. The rest of the dropdown menu is white with black text. The options listed are: "1 No Special Function", "3 Vehicle Used as School Bus", "4 Vehicle Used as Other Bus", "5 Military", "6 Police", "7 Ambulance", "8 Fire Truck", and "2 Taxi".

No Special Function: The vehicle involved in the crash has any special function as defined by the list above.

Vehicle Used as a School Bus: would apply to a motor vehicle being used by a public or private school or school system to transport children up to the 12th Grade to/from school or any other school function or activity. This includes chartered buses. The body type can be van-based.

Vehicle used as Other Bus: would apply to a vehicle that is functioning as a "Bus" by virtue of its configuration to carry more than 8 passengers including the driver. An example would be a motor coach, a 10 passenger limousine, van-based shuttle bus, or a tour bus.

Military: refers to a vehicle which is owned by any of the Armed Forces. These vehicles are presumed to be in special military use at all times. This includes all military vehicles even if they are police, ambulance, or fire trucks.

Police: A vehicle equipped with police emergency devices (lights and siren) that is owned or subsidized by any local, county, state or federal government entity. The police vehicle is presumed to be in special use at all times, although not necessarily in "emergency use."

Vehicles not owned by a government entity that are used by law enforcement officers (e.g., undercover) are excluded.

Ambulance: refers to vehicles: (1) whose sole purpose is to provide ambulance service and which is always presumed to be in special ambulance use at all times, or (2) vehicles serving dual purposes such as a hearse used for both funeral and emergency purposes, which is only coded when used for the latter purpose. This includes both publicly and privately owned vehicles.

Fire Truck: refers to a vehicle which is owned by any local, county, state or fire protection agency. The vehicles are presumed to be in special use at all times. Personal vehicles (not owned by the agency) that are used by officers or agents are excluded.

Taxi: refers to vehicles used during this trip (at the time of the crash) on a fee-for-hire basis to transport persons. Most of these vehicles will be marked and formally registered as taxis; however, vehicles that are used as taxis, even though they are not registered (e.g., Gypsy Cabs), are included here. Taxis and drivers who are off-duty at the time of the accident are considered "No Special Function."

37 Responding to Scene?

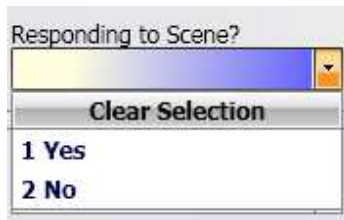

The screenshot shows a window titled "Responding to Scene?". At the top is a dropdown menu with a yellow-to-blue gradient bar and a downward arrow. Below the dropdown is a "Clear Selection" button. Underneath are two radio button options: "1 Yes" and "2 No".

Definition: Indicates operation of any motor vehicle that is legally authorized by a government authority to respond to emergencies with or without the use of emergency warning equipment, such as a police vehicle, fire truck, or ambulance while actually engaged in such response. Select "Yes" only if the motor vehicle involved in the crash was on an emergency response, regardless of whether the emergency warning equipment was in use.

Rationale: Driver behavior related to emergency vehicle response is an emerging national issue. This is true for both operators of emergency vehicles and operators of vehicles in the vicinity of an emergency vehicle engaged in a response. It is the intent of this element to gather information that will guide development of training or other countermeasures to reduce the number of crashes involving emergency vehicle response.

Damage

38

Extent of Damage



The screenshot shows a software window titled "Extent of Damage". At the top, there is a dropdown menu currently displaying "No Damage Observed". Below the dropdown is a button labeled "Clear Selection". Underneath that is a list of four numbered options: "1 No Damage Observed", "2 Minor Damage", "3 Functional Damage", and "4 Towed Due to Disabling Damage". The first option is highlighted in yellow.

Definition: Estimation of the total damage to a motor vehicle from the crash.

Rationale: Standardizing the extent of damage a motor vehicle sustains in a crash is essential to consistent collection of crash data. Towed Due to Disabling Damage is important to identifying non-injury, tow-away crashes involving any vehicle towed due to damage sustained in the crash. This information is vital to Federal Motor Carrier Safety Administration in their selection criteria for truck and bus crashes.

No damage observed: No Damage is used for those that are driven from the scene or towed for other reasons (i.e., the driver is arrested or without required license, vehicle is placed out of service because it is unsafe to drive or impounded, etc.). Towing assistance without removal of the vehicle from the scene, such as pulling a vehicle out of a ditch, is not considered to be towed for the purposes of this element.

Minor Damage: Damage which does not affect the operation of or disable the motor vehicle in transport.

Functional Damage: Damage that is not disabling, but affects the operation of the motor vehicle or its parts.

Disabling Damage: Damage that precludes departure of the motor vehicle from the scene of the crash in its usual daylight-operating manner after simple repairs. As a result, the motor vehicle had to be towed, or carried from the crash scene, or assisted by an emergency motor vehicle. This selection also includes vehicles which could be driven but would be further damaged thereby.

Towed Due to Disabling Damage: Identifies whether a vehicle involved in a crash is removed from the scene as a result of the disabling damage.

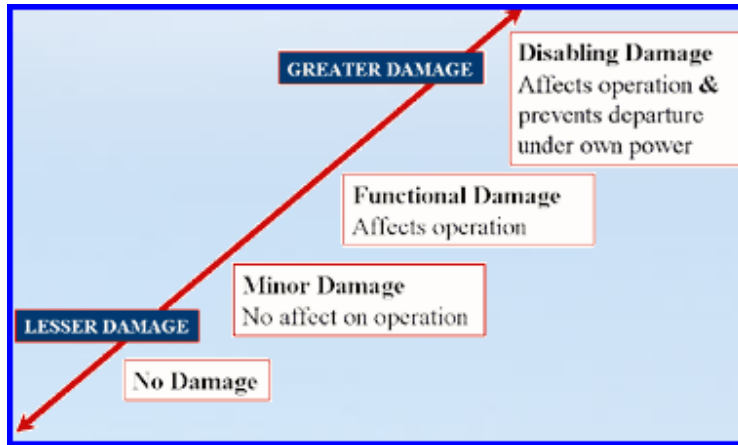

39 Most Damaged Area

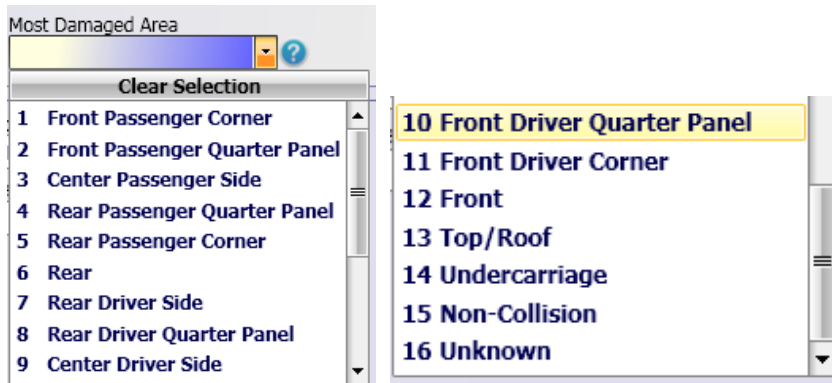

Definition: The area of the motor vehicle that was most damaged in a crash.

Rationale: Important for use in evaluating injury severity in relation to motor vehicle impact and crash severity.

Use the illustration below to select the appropriate damage area:

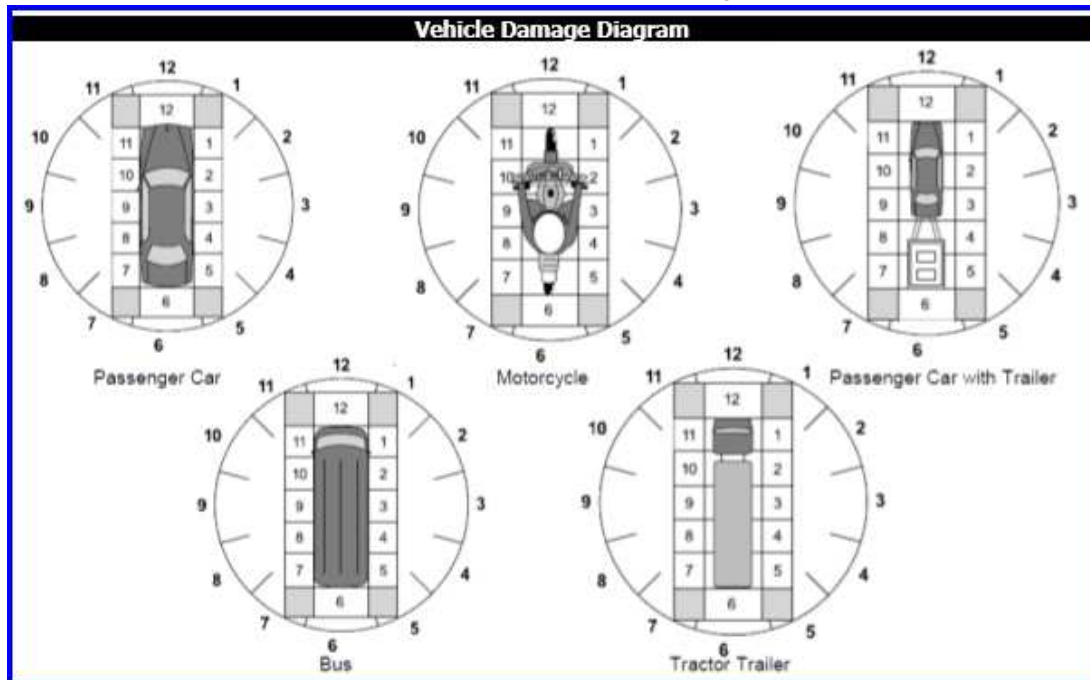

Example:



In this photo series, assume V1 struck V2, Angle Same Direction. Based on the Clock Point Diagrams: V1 = 11 or 12 and V2 = 7

Actions

Definition: Describes the actions of the vehicle leading up to the crash including direction of travel, most harmful event, pre-crash actions, contributing circumstances and sequence of events.

Rationale: Important for use in conjunction with Most Harmful Event, and Sequence of Events to generate complete information about the crash.

40 Vehicle Direction of Travel

Vehicle Travel Direction
Northbound
Clear Selection
1 Northbound
2 Southbound
3 Eastbound
4 Westbound
5 Not On Roadway
6 Unknown

Definition: The direction of a motor vehicle's travel on the roadway before the crash. Notice that this is not a compass direction, but a direction consistent with the designated direction of the road. For example, the direction of a state designated North-South highway must be either Northbound or Southbound even though a motor vehicle may have been traveling due east as a result of a short segment of the highway having an East-West orientation.

Rationale: Important to indicate direction the motor vehicle was traveling before the crash for evaluation purposes.

Example 1:

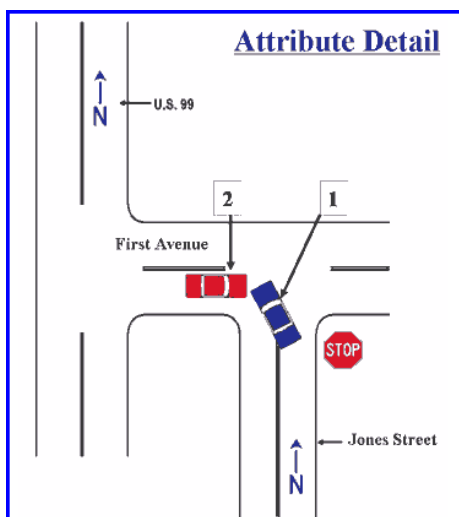

When a crash occurs while a vehicle is making a turn at an intersection and the location of the crash is within the intersection, the direction of travel is the direction of the vehicle prior to the turning movement. In the example, V#1 is making a left hand turn in a westerly direction but would be recorded as NORTHBOUND. V#2 would be recorded as EASTBOUND.

Example 2:

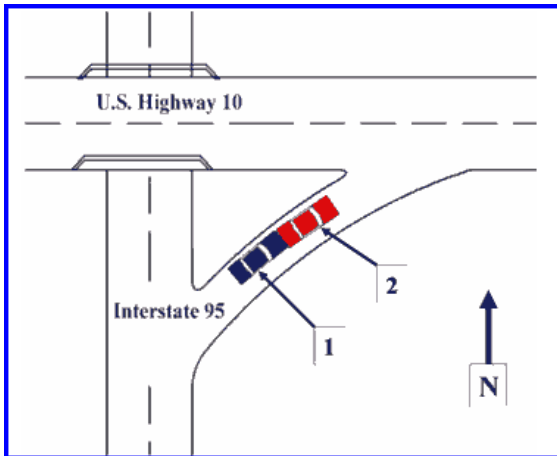

In example 2, U.S. 99 is designated a North-South highway. Although the motor vehicles were traveling due east/west as a result of a short segment of the highway having an East-West orientation and the crash occurred in that portion of the highway, the proper recording of direction of travel would be NORTHBOUND for V#1 and SOUTHBOUND for V#2.

Example 3:

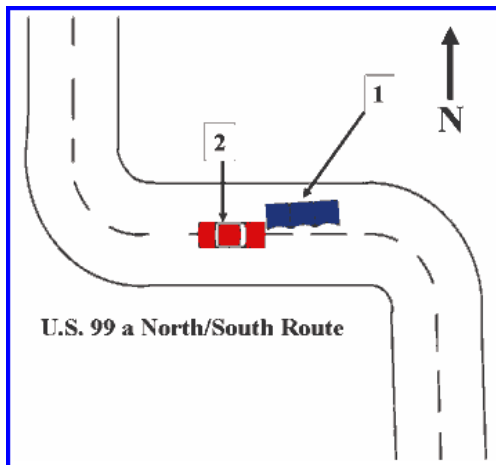

In example, Interstate 95 is a designated N/S route and U.S. 10 is E/W. Vehicle (1) strikes vehicle (2) on the ramp from I-95 to Eastbound U.S 10. Although both intended to go Eastbound on U.S. 10, the Direction of Travel for vehicles on ramps and connector roads should be determined by assuming that the route direction of the parent highway is the true direction. Thus, both would be recorded as Northbound on U.S. 95.

Most Harmful Event

Most Harmful Event

Motor Vehicle in Transport

Clear Selection

- 1 Overturn / Rollover
- 2 Fire / Explosion
- 3 Immersion
- 4 Jackknife
- 5 Cargo / Equipment Loss Or Shift
- 6 Fell / Jumped from Motor Vehicle
- 7 Thrown or Falling Object
- 8 Other Non-Collision
- 9 Pedestrian

Clear Selection

- 10 Pedalcycle
- 11 Railway Vehicle - Train, Engine
- 12 Animal
- 13 Motor Vehicle in Transport
- 14 Parked Motor Vehicle
- 15 Struck by Falling, Shifting Cargo or Anything Set in Motion by Motor Vehicle
- 16 Work Zone / Maintenance Equipment
- 17 Other Non-Fixed Object
- 18 Impact Attenuator / Crash Cushion

Clear Selection

- 19 Bridge Overhead Structure
- 20 Bridge Pier or Support
- 21 Bridge Rail
- 22 Cable Barrier
- 23 Culvert
- 24 Curb
- 25 Ditch
- 26 Embankment
- 27 Guardrail Face

Clear Selection

- 28 Guardrail End
- 29 Concrete Traffic Barrier
- 30 Other Traffic Barrier
- 31 Tree (Standing)
- 32 Utility Pole / Light Support
- 33 Traffic Sign Support
- 34 Traffic Signal Support
- 35 Fence
- 36 Mailbox

- 37 Other Post Pole or Support
- 38 Other Fixed Object (wall, building, tunnel, etc.)
- 39 Unknown
- 40 Gate or Cable
- 41 Pressure Ridge

Definition: Event that resulted in the most severe injury or, if no injury, the greatest property damage involving this motor vehicle.

Rationale: Important for use in conjunction with the Sequence of Events to generate complete information about the crash.

Clarification: This event must be the major event for this vehicle. Thus, it may differ from the First Event and be different for each vehicle involved in the crash. When choosing the event remember that is the most harmful "for this vehicle" using the following hierarchy:

1. An event that produces a fatality takes precedence over an event that produces an injury.
2. An event that produces an injury takes precedence over an event that produces property damage.

Non-Collision

Overturn/Rollover: A motor vehicle that has overturned at least 90 degrees to its side

Fire / Explosion: A fire / explosion that was the cause or result of the crash.

Immersion: A non-collision harmful event where an object or person becomes covered completely by liquid.

Jackknife: An uncontrolled articulation between a tractor and trailer(s) that occurs at any time during the crash sequence.

Cargo/Equipment Loss or Shift: As a non-collision, Most Harmful Event, the loss or shift would have to cause damage to the motor vehicle or occupants that is transporting the cargo/equipment or the cargo or equipment itself. If cargo/equipment is lost and strikes another vehicle that is a collision event.

Note: Refers specifically to the loss or shift of items carried on or in a motor vehicle or its trailing unit, and not to the vehicle or trailing unit, itself. This attribute is only used as the Most Harmful Event in crashes where the loss or shift causes damage to this vehicle, its cargo, or injury to its occupants that event is the most damage- or injury-producing event for this vehicle. This attribute should never be used to refer to a 'collision' event.

Fell/Jumped from Motor Vehicle: Is used when a person falls or jumps from the vehicle. For example, a passenger of a motor vehicle in transport leans against the car door, it opens and the passenger falls out and is injured by the fall.

Note: If a person intentionally jumps or is pushed from a motor vehicle this would not qualify as a state reportable traffic crash and would not be submitted to the state crash database.

Thrown or Falling Object: A non-collision event where an object is thrown or falls on a motor vehicle in transport at the time of the crash.

Clarification: As a (first or most) harmful event, the thrown or falling object would have to strike a motor vehicle in transport and cause injury or damage. This attribute is also used in Sequence of Events and is not necessarily harmful in every crash.

Examples:

Cargo/Equipment Loss or Shift - A pick-up truck hauling lumber brakes rapidly to avoid a collision which causes a board to smash the rear window and injure the driver.

Motor Vehicle In-transport for V#1, Struck by Falling, Shifting Cargo for V#2) - A pick-up (V#1) hauling lumber swerves to avoid a collision on an overpass which causes a board to dislodge and fall on a vehicle (V#2) traveling on the roadway below.

Thrown or Falling Object - Includes thrown objects that unintentionally strike vehicles in the roadway. Examples: Falling Tree/Rock, dropping/throwing something off a bridge, being struck by a golf ball. **Note:** If an object is intentionally thrown or dropped the crash would not qualify as a state reportable traffic crash and would not be submitted to the state crash database.

Other Non-Collision: May include:

1. Driving off a cliff where damage is not the result of an overturn or a collision with a fixed object.
2. An unbelted passenger hits his or her head on the roof of a vehicle and is injured, when the vehicle travels over a sharp dip in the road.

3. Situations where a passenger is sickened or dies due to carbon monoxide fumes leaking from a motor vehicle in transport.
4. This also includes when an occupant of a vehicle is run over by his/her own vehicle after falling from the vehicle.

Collision with Person, Motor Vehicle, or Non-Fixed Object

Pedestrian: A person who is not an occupant of a motor vehicle in transport. This includes a person who is adjacent to the motor vehicle regardless of his/her actions.

Pedalcycle: Includes bicycle, tricycle, unicycle, pedal car, etc.

Railway Vehicle: Any land vehicle (train, engine) that is (1) designed primarily for moving persons or property from one place to another on rails and (2) not in use on a land way other than a railway.

Animal: Any collision with an animal that produces the most harmful event.

Motor Vehicle in Transport: A motor vehicle is any motorized (mechanically or electrically powered) road vehicle not operated on rails. When applied to motor vehicles, 'in-transport' refers to being in motion or on a roadway.

Inclusions:

- *Motor vehicle in traffic on a highway*
- *Driverless motor vehicle in motion*
- *Motionless motor vehicle abandoned **on a roadway***
- *Disabled motor vehicle **on a roadway**, etc.*
- *A stopped motor vehicle with any portion of its primary outline as defined by the four sides of the vehicle (e.g., tires, bumpers, fenders) and load, if any, within the roadway*

Examples:

1. *A driverless vehicle previously parked on the shoulder begins to roll forward because the parking brake was not set.*
2. *A stopped vehicle partially on the shoulder with two tires on the roadway.*
3. *A tractor trailer with its load hanging over the roadway edge line*
4. *A person deliberately driving an all-terrain vehicle (ATV) down a median or the roadside*

5. *A police vehicle patrolling or responding to an emergency*
6. *A police or emergency vehicle stopped on the roadway at the scene of an accident or traffic stop or other police action, regardless of whether or not the emergency lights have been activated.*
7. *Construction, maintenance or utility work vehicle traveling on a trafficway from one work site to another location.*
8. *Taxi, limousine or other passenger vehicle, with or without passengers while on the roadway or in motion on a trafficway.*
9. *A school bus stopped in a travel lane with signs and/or lights activated.*
10. *A private citizen using his pickup truck or lawn tractor with a blade removing snow from the roadways in his neighborhood (Not a highway maintenance activity).*
11. *A farm tractor or combine moving from a storage facility to a field under its own power on the trafficway.*
12. *A moving motor vehicle on a private driveway*
13. *A car pulling away from a gas pump in a gas station.*
14. *An ATV driving on a recreational off-road trail inside or outside the trafficway.*
15. *A vehicle operating in the closed portion of the trafficway.*
16. *A van left unattended in a lane during rush hour when parking is prohibited because it is in an open travel lane at the time.*

Exclusions:

- *Transport vehicle stopped off the roadway within the trafficway.*
- *Transport vehicle stopped in parking lanes during periods when parking is allowed.*
- *Transport vehicle performing construction, maintenance or utility work related to the work zone of a trafficway.*
- *A stopped motor vehicle with any portion of its primary outline as defined by the four sides of the vehicle (e.g., tires, bumpers, fenders) and load, if any, **not within the roadway.***

Examples:

- 1.) *A disabled utility vehicle stopped on the shoulder, median or roadside.*
- 2.) *An automobile parked in an area designated for parking against the curb of a residential street or in a parking space/lane.*
- 3.) *A truck stopped on the shoulder where only the extended side-view mirror overhangs the roadway edge line.*
- 4.) *A power company truck working on the power lines in an elevated basket in a maintenance work zone.*
- 5.) *A paint striping highway truck in the act of painting the lines in a mobile maintenance zone.*
- 6.) *A concrete mixer discharging its load of concrete in a construction work zone.*
- 7.) *An asphalt spreader or roller repaving the roadway.*
- 8.) *A highway road grader overturns grading a soft, sloped roadside.*
- 9.) *Highway snow removal truck removing or plowing snow as part of a highway maintenance activity.*

Parked Motor Vehicle: A parked motor vehicle is a motor vehicle not in-transport, other than a *working motor vehicle*, that is not in motion and **not located on the roadway**.

A working motor vehicle is a maintenance or utility vehicles performing repair work and not in motion

In roadway lanes used for travel during some periods and for parking during other periods, a parked motor vehicle should be considered to be in-transport during periods when parking is forbidden.

Any stopped motor vehicle where the entirety of the vehicle's primary outline as defined by the four sides of the vehicle (e.g., tires, bumpers, fenders) and load, if any, is not within the roadway is parked.

Inclusions:

- *Any stopped motor vehicle where the entirety of the vehicle's primary outline as defined by the four sides of the vehicle (e.g., tires, bumpers, fenders) and load, if any, is not within the roadway.*

Examples:

1. *A driver of vehicle stopped curbside on a city street opens his door into the travel lane.*

2. *A truck stopped on the shoulder where only the extended side-view mirror overhangs the roadway edge line.*
3. *A motionless vehicle on the shoulder, median or roadside.*
4. *A truck stopped at a gas station pump.*
5. *A car stopped in a private driveway.*
6. *A van parked in a metered parking lane, even when the meter time has expired.*

Exclusions:

- *A motor vehicle in motion anywhere within the trafficway boundaries or any vehicle that has any portion of its primary outline or load, if any, overlapping or falling completely within the roadway.*
- *A motor vehicle left unattended on a roadway, where parking is always prohibited.*

Examples:

1. *A vehicle driving down the road shoulder, median or roadside.*
2. *A driverless motor vehicle without engine power starts in motion from a stopped position on the shoulder.*
3. *A stopped vehicle partially on the shoulder with two tires on the roadway.*
4. *A tractor trailer with part of its load extending over the roadway edge line.*
5. *A van left unattended in a lane during rush hour when parking is prohibited because it is in an open travel lane at that time.*
6. *A delivery service leaves his truck stopped at the curb of a street marked with "no parking at any time" signs while making his delivery.*

Struck by Falling, Shifting Cargo or Anything Set in Motion by a Motor Vehicle: In accidents involving harmful events caused by objects set-in-motion by a Motor Vehicle in Transport, remember that a vehicle's "load" is considered part of the vehicle (see ANSI D16 definition of a Transport Vehicle). An example of this attribute would be if cargo falls from a truck (in transport) and strikes another vehicle in transport. This is treated as a two-vehicle accident where this attribute would apply as the Most Harmful Event for the vehicle struck by the load (cargo).

Work Zone / Maintenance Equipment: Equipment related to the work zone or roadway maintenance.

Clarification: Crashes can be Work Zone Related if the first harmful event occurred outside the boundaries of the Work Zone, but the Work Zone or Equipment related to the work zone were involved in the sequence of events.

Other Non-Fixed Object: A collision with an object other than a motor vehicle in transit, a pedestrian, another road vehicle in transit, a parked motor vehicle, a railway vehicle, a pedal cycle, an animal, or a fixed object. **Only select “Other” if none of the other listed “Non-Fixed Object” descriptions are appropriate.**

Collision with Fixed Object

Impact Attenuator / Crash Cushion: A barrier at a spot location, less than 25ft. (7.6 m) away, designed to prevent an errant motor vehicle from impacting a fixed object hazard by gradually decelerating the motor vehicle to a safe stop or by redirecting the motor vehicle away from the hazard.



Bridge Overhead Structure: Any part of a bridge that is over the reference or subject roadway. In crash reporting, this typically refers to the beams or other structural elements supporting a bridge deck.

Bridge Pier or Support: Support for a bridge structure including the ends (abutments).



Bridge Rail: A barrier attached to a bridge deck or a bridge parapet to restrain motor vehicles, pedestrians or other users.



Cable Barrier: Refers to a flexible barrier system which uses several cables typically supported by steel posts. These can be used on the roadside or as a median barrier. These barriers are designed to help lessen impact or keep vehicles within the confines of the road.



Culvert: An enclosed structure providing free passage of water under a roadway with a clear opening of less than twenty feet measured along the center of the roadway.



Curb: A raised edge or border to a roadway. Curbs may be constructed of concrete, asphalt, granite or wood and typically have a face height of less than 9 inches.



Ditch: Developed primarily to collect and move water. It is adjacent to a highway and is usually identified as the roadside.

Embankment: Raised structures to hold back water, to carry or support a roadway, or the result of excavation or washout that may be faced with earth, rock, stone or concrete. An embankment can usually be differentiated from a wall by its incline, whereas a wall is usually vertical.



Guardrail Face: Areas along a guardrail stretch other than the ends.

Guardrail End: As in the photo below, the guardrail end is typically painted a warning color and may include a breakaway or redirection design feature not to be confused with an impact attenuator.



Concrete Traffic Barrier: Refers to the longitudinal traffic barriers constructed of concrete and located on the outside of the road surface, in a median, or in gore areas. This includes all temporary concrete barriers regardless of location (i.e., temporary barrier on a bridge being used to control traffic during bridge repair/construction).

Other Traffic Barrier: Longitudinal barriers other than guardrails, concrete traffic barriers, or cable barriers. They may be composed of material such as wood or rock.

Tree (Standing): A tree that is standing and not uprooted.

Utility Pole/Light Supports: Constructed for the primary function of supporting an electric line, telephone line or other electrical-electronic transmission line or cable.

Traffic Sign Support: A pole, post or other type of support for a traffic sign.



Traffic Signal Support: A pole, post or other type of support for a traffic signal.

Fence: A fence is a freestanding structure designed to restrict or prevent movement across a boundary. Choose this selection when the most harmful event was an impact with a fence.



Mailbox: A letter box, copper box, or other sturdy material compartment mounted on a post for incoming postal deliveries. Choose this selection when the most harmful event was an impact with a mailbox.

Other Post Pole or Support: Post, pole or support that does not include a highway safety sign.

Other fixed Object (wall, building, tunnel, etc.)

Unknown: Only choose unknown when it is not known what caused the most harmful event. This selection should not be used if the crash investigator is on scene.

Gate or Cable: A gate or cable is a point of entry to a field, trail or fence that may prevent or control entry or exit.



Pressure Ridge: A pressure ridge is an ice formation typically found on large frozen lakes or sea ice during the winter caused by repeated heating and cooling on the surface of the lake. In cold weather, ice will shrink in volume, opening up cracks in the surface of lakes that are completely frozen over. The cracks quickly fill with water and freeze again, but when the temperature rises later, the ice expands and forces itself upward along the lines of the crack.



42 **Pre-Crash Actions**

Pre Crash Actions	
Following roadway	
Clear Selection	
1 Following roadway	10 Slowing in traffic
2 Wrong way into opposing traffic	11 Stopped in traffic
3 Right turn on red	12 Entering parked position
4 Left turn on red	13 Parked Legally
5 Making right turn	14 Parked Illegally
6 Making left turn	15 Avoiding Vehicle Object, Pedestrian, Animal in Roadway
7 Making U turn	16 Skidding
8 Starting from parked	17 Changing Lanes
9 Starting in traffic	18 Overtaking Passing
19 Merging	
20 Backing	
30 Other Vehicle Action	
31 Following Trail	
99 Unknown	

Definition: The controlled maneuver for this motor vehicle prior to the beginning of the Sequence of Events. The last action for this vehicle before the start of the unstabilized situation that begins the crash.

Rationale: Important for evaluation purposes, particularly when combined with Sequence of Events.

Following Roadway: Vehicle is moving along the roadway in the proper travel lane.

Wrong way into opposing traffic: Any situation in which the driver is operating a vehicle within an opposing traffic lane. This does not include improper passing or failing to keep in proper lane. Wrong Way is for driving the wrong direction on a one-way roadway or the wrong way on a divided trafficway.

Right turn on red: Select this when the vehicle is in the actual **process** of executing a right turn on a red signal at an intersection.

Left turn on red: Select this when the vehicle is in the actual **process** of executing a left turn on a red signal at an intersection.

Making right turn: Select this when a vehicle is in the **process** of executing a right turn at an intersection, interchange, driveway access, etc. This would not apply to a vehicle that is waiting to initiate a turn, see Stopped in Traffic.

Making left turn: Select this when a vehicle is in the **process** of executing a left turn at an intersection, interchange, driveway access, etc. This would not apply to a vehicle that is waiting to initiate a turn, see Stopped in Traffic.

Making U turn: Select this when a vehicle is in the process of changing directions by 180 degrees.

Starting from parked: Select this when a vehicle is entering a traffic lane from a parked position.

Starting in traffic: Physical presence in trafficway. This includes starting from a stop sign, or a signal, and merging.

Slowing in traffic: Slowing while in the trafficway.

Stopped in traffic: Applies to a vehicle which is stopped on the trafficway in an area normally used for vehicle travel (i.e. outside a parking lane). It includes but is not limited to motor vehicles legally stopped for a stop sign or signal, motor vehicles stopped to turn PRIOR to initiating a turn, motor vehicles stopped in traffic due to a slow down in traffic ahead, and motor vehicles illegally stopped in a traffic lane. A vehicle stopped in traffic may or may NOT have a driver and the vehicle engine may or may NOT be running. Most double parked vehicles are actually stopped in traffic rather than parked*. *Note - a vehicle that is "stopped in traffic" is by definition a motor vehicle in-transport.

Entering parked position: A vehicle that is in the process of entering a parked position either legally or illegally. This would include a vehicle that is parallel parking.

Parked legally: A transport motor vehicle that is not in motion or on a roadway. A motor vehicle, or any portion of the motor vehicle outline, parked on the roadway during periods when parking is prohibited is considered in transport.

Parked illegally: A vehicle, whether attended or unattended, that is parked on the traveled portion of a public way outside of a business or residence district when it is practicable to park off of the way, or when there is not:

(1) A clear and unobstructed width of at least 10 feet left for free passage of other vehicles on the way; and

(2) A clear view of the way for 300 feet beyond the parked vehicle for an oncoming vehicle, before approaching within 200 feet of it.

Or; a vehicle on a limited-access highway:

(1) On a traffic lane, deceleration lane, acceleration lane or on a bridge; or

(2) On the shoulder to the left of the traffic lanes.

Or; a vehicle that is stopped or parked in violation of a parking restriction sign.

This would **NOT** apply to vehicles that are:

(1) Disabled to the extent that it is impossible to avoid stopping and temporarily leaving the vehicle; or

(2) Employed in construction, maintenance or repair of pipes and wires of a public utility in, on, along, over, across or under a public way.

Avoiding vehicle, object, pedestrian, or animal in roadway: A defensive driver action to defend against an apparent danger in, on, or due to the condition of the roadway or the presence of a motor vehicle or object or non-motorist in the roadway in order to avoid a crash.

Skidding: A vehicle that is braking to the extent that some or all of the brakes are locked or the ABS system is activated, or the vehicle is no longer traveling parallel to the roadway in an uncontrolled manner.

Changing lanes: Shifting from one traffic lane to another traffic lane while moving in the same direction.



In the example to the left, the red car could be in the act of overtaking the white car (Position A B C). The arrows show the points where the red car was changing lanes. Determination of whether this is changing lanes or passing would be by officer investigation. Note that on an undivided highway moving into an opposing travel lane would not be changing lanes.

Overtaking / Passing: A motor vehicle that moves from behind a motor vehicle to in front of the same motor vehicle.

Merging: When a vehicle is merging from one flow of traffic to another at a lane or on-ramp used that is used to merge two flows of traffic into one.

Backing: A start from a parked or stopped position in the direction of the rear of the motor vehicle.

Other vehicle action: Only select “Other vehicle action” if none of the other listed “Vehicle Action” descriptions are appropriate.

Following trail: When an off-road vehicle is traveling on a recreational trail defined as follows: A designated land corridor or body of water that provides recreational, aesthetic, alternate transportation or educational opportunities to off-road motorized and non-motorized users.

Unknown: The investigating officer can not verify the pre-crash action of this vehicle. **This should only be checked if an officer was not present at the crash scene at the time of the crash or shortly after.** Every attempt should be made to verify the pre-crash actions of all vehicles involved in the crash.

43 Contributing Circumstances Vehicle

Contributing Circumstances - Vehicle

None

Clear Selection

1 None	10 Lights (head, signal, tail, brake)
2 Brakes	11 Windows/Windshield
3 Exhaust System	12 Mirrors
4 Body, Doors	13 Wipers
5 Steering	14 Truck Coupling / Trailer Hitch / Safety Chains
6 Power Train	15 Other
7 Suspension	
8 Tires	
9 Wheels	

Definition: Pre-existing motor vehicle defects or maintenance conditions that may have contributed to the crash.

Rationale: Important for determining the significance of pre-existing problems, including equipment and operation, in motor vehicles involved in crashes that could be useful in determining the need for improvements in manufacturing.

None: The crash is not attributed to any vehicle conditions.

Brakes: Includes loss of break fluid (or system error), faded brakes, or ineffective brakes due to a grossly overloaded vehicle. This excludes locked wheels.

Exhaust system: Includes exhaust system leaking into vehicle and exhaust manifold(s), headers, muffler, catalytic converter, tailpipe, etc.

Body, doors: Includes trunk, hood, tailgate, rear doors of cargo vans, etc.

Steering: Includes failure of manual or power steering mechanism, tie rod, kingpin, ball joint, etc.

Power train: Includes twisted or sheared driveline, or driveline that has become detached. Also includes universal joint, drive shaft, transmission, engine, clutch, gas pedal, motorcycle chain, gears, etc.

Suspension: Includes springs, shock absorbers, MacPherson struts, axle bearing, control arms, etc. Also includes modification to standard suspension (Suspension Lift Kit).

Tires: Defective tires, tread separation, sidewall failure, excessively worn, bubbled, or bald tires. Tires improperly sized for this vehicle. This Excludes improper tire pressure, which is due to driver irresponsibility and tire damage produced in the crash (hitting pot hole, curb, etc.).

Wheels: Includes wheels that have collapsed or split, or bolts that have sheared, allowing the wheel to detach from the vehicle. Also includes hub caps, multiple-piece rings.

Lights (head, signal, tail, brake): Defective/faulty/under-maintained as opposed to failure to use or misuse.

Windows/Windshield: Window tinting, windshield cracked

Mirrors: Includes missing mirrors.

Wipers: Defective/faulty/under-maintained as opposed to failure to use.

Truck coupling / Trailer hitch / safety chains: Defective trailer hitch denotes improperly adjusted trailer hitch, lack of safety chain, 5th wheel hitch, etc. Improper towing denotes towing without a hitch, towing by cable, rope, chain, etc.

Other: (If chosen should be explained in narrative) would include defects such as horn, defrosters, broken engine belts that result in loss of power steering, restraint system (accidental air bag deployment), exhaust system failure, fuel system. **Only select "Other" if none of the other listed "Contributing Circumstances Vehicle" descriptions are appropriate.**

44 **Sequence of Events 1, 2, 3, and 4**

Definition: The events in sequence related to this motor vehicle, including both non-collision as well as collision events.

Rationale: Important for use in conjunction with Most Harmful Event and Motor, Pre-Crash Actions, and Driver Actions at Time of Crash to generate complete information about the crash.

Non-Collision Events

Note: Up to four Sequence of Events may be selected.

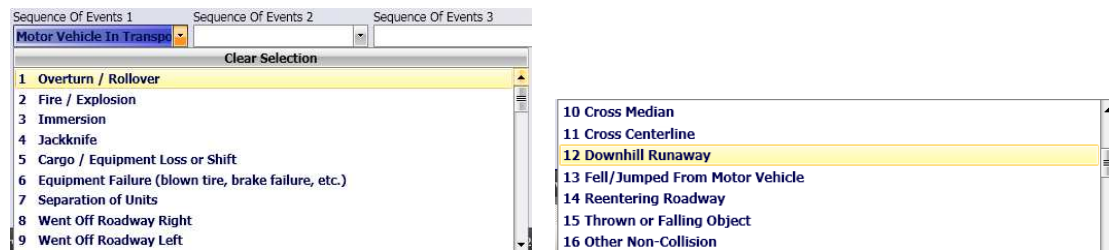

Overturn/Rollover: A motor vehicle that has overturned at least 90 degrees to its side

Fire / Explosion: A fire / explosion that was the cause or result of the crash.

Immersion: A non-collision harmful event where an object or person becomes covered completely by liquid.

Jackknife: An uncontrolled articulation between a tractor and trailer(s) that occurs at any time during the crash sequence.

Cargo/Equipment Loss or Shift: As a non-collision event in the Sequence of Events, a cargo/equipment loss or shift is not necessarily harmful.

Example: The loss or release of the goods being transported from the cargo compartment of the truck, or the shifting of position of the load affecting its balance.

As a harmful event, the loss or shift would have to cause damage to the motor vehicle or occupants that is transporting the cargo/equipment or the cargo or equipment itself.

Note: *Refers specifically to the loss or shift of items carried on or in a motor vehicle or its trailing unit, and not to the vehicle or trailing unit, itself. This attribute is only used as the Most Harmful Event in crashes where the loss or shift causes damage to this vehicle, its cargo, or injury to its occupants that event is the most damage- or injury-producing event for this vehicle. This attribute should never be used to refer to a 'collision' event.*

Equipment Failure (blown tire, brake failure etc.): If an equipment failure led to the crash or an event of the crash.

Separation of Units: When the truck or truck tractor becomes separated from the semi-trailer and/or trailer(s) it is pulling. (Includes passenger cars)

Went off Roadway Right: When the vehicle leaves the area identified as the roadway on the right hand side.

Went off Roadway Left: When the vehicle leaves the area identified as the roadway on the left hand side.

Cross Median: Is used when a vehicle completely crosses the median and enters the shoulder or travel lane on the opposite side of a divided highway.

Cross Centerline: Is used for a vehicle that crosses over the center line of a two-way, undivided highway.

Downhill Runaway: When a parked vehicle is set in motion due to grade or vehicle malfunction, or, when a malfunction causes a vehicle traversing a grade to lose control.

Fell/Jumped from Motor Vehicle: Is used when a person falls or jumps from the vehicle. For example, a passenger of a motor vehicle in transport leans against the car door, it opens and the passenger falls out and is injured by the fall.

Note: *If a person intentionally jumps or is pushed from a motor vehicle this would not qualify as a state reportable traffic crash and would not be submitted to the state crash database.*

Reentering Roadway: Is used when a vehicle that departed the roadway portion of the trafficway returns to the roadway. (e.g. - a motor vehicle in-transport runs off the roadway right, strikes the guardrail face, then reenters the roadway and collides with another motor vehicle in-transport.)

Thrown or Falling Object: A non-collision event where an object is thrown or falls on a motor vehicle in transport at the time of the crash.

Clarification: As a (first or most) harmful event, the thrown or falling object would have to strike a motor vehicle in transport and cause injury or damage. This attribute is not necessarily harmful in every crash. (See examples in Most Harmful Event)

Example: A pick-up truck hauling used tires along a two-lane divided highway breaks rapidly in an attempt to avoid a collision which causes some tires to dislodge and fall onto the roadway in the adjacent travel lane on its side of the divided highway. A vehicle in the other travel lane runs off the road and strikes a tree when avoiding the tires.

Other Non-Collision:

1. Driving off a cliff where damage is not the result of an overturn or a collision with a fixed object.
2. An unbelted passenger hits his or her head on the roof of a vehicle and is injured, when the vehicle travels over a sharp dip in the road
3. Situations where a passenger is sickened or dies due to carbon monoxide fumes leaking from a motor vehicle in transport.
4. This also includes when an occupant of a vehicle is run over by his/her own vehicle after falling from the vehicle.

Collision with Person, Motor Vehicle, or Non-Fixed Object

Pedestrian: A person who is not an occupant of a motor vehicle in transport. This includes a person who is adjacent to the motor vehicle regardless of his/her actions.

Pedalcycle: Includes bicycle, tricycle, unicycle, pedal car, etc.

Railway Vehicle: Any land vehicle (train, engine) that is (1) designed primarily for moving persons or property from one place to another on rails and (2) not in use on a land way other than a railway.

Animal: Any collision with an animal that produces the most harmful event.

Motor Vehicle in Transport: A motor vehicle is any motorized (mechanically or electrically powered) road vehicle not operated on rails. When applied to motor vehicles, 'in-transport' refers to being in motion or on a roadway. Inclusions: motor vehicle in traffic on a highway, driverless motor vehicle in motion, motionless motor vehicle abandoned **on a roadway**, disabled motor vehicle **on a roadway**, etc.

Parked Motor Vehicle: A parked motor vehicle is a motor vehicle not in-transport, other than a working motor vehicle, that is not in motion and **not located on the roadway**.

A working motor vehicle is a maintenance or utility vehicles performing repair work and not in motion

In roadway lanes used for travel during some periods and for parking during other periods, a parked motor vehicle should be considered to be in-transport during periods when parking is forbidden.

Any stopped motor vehicle where the entirety of the vehicle's primary outline as defined by the four sides of the vehicle (e.g., tires, bumpers, fenders) and load, if any, is not within the roadway is parked.

Inclusions:

- *Any stopped motor vehicle where the entirety of the vehicle's primary outline as defined by the four sides of the vehicle (e.g., tires, bumpers, fenders) and load, if any, is not within the roadway.*

Examples:

1. *A driver of vehicle stopped curbside on a city street opens his door into the travel lane.*
2. *A truck stopped on the shoulder where only the extended side-view mirror overhangs the roadway edge line.*
3. *A motionless vehicle on the shoulder, median or roadside.*

4. *A truck stopped at a gas station pump.*
5. *A car stopped in a private driveway.*
6. *A van parked in a metered parking lane, even when the meter time has expired.*

Exclusions:

- *A motor vehicle in motion anywhere within the trafficway boundaries or any vehicle that has any portion of its primary outline or load, if any, overlapping or falling completely within the roadway.*
- *A motor vehicle left unattended on a roadway, where parking is always prohibited.*

Examples:

1. *A vehicle driving down the road shoulder, median or roadside.*
2. *A driverless motor vehicle without engine power starts in motion from a stopped position on the shoulder.*
3. *A stopped vehicle partially on the shoulder with two tires on the roadway.*
4. *A tractor trailer with part of its load extending over the roadway edge line.*
5. *A van left unattended in a lane during rush hour when parking is prohibited because it is in an open travel lane at that time.*
6. *A delivery service leaves his truck stopped at the curb of a street marked with "no parking at any time" signs while making his delivery.*

Struck by Falling, Shifting Cargo or Anything Set in Motion by a Motor Vehicle: In accidents involving harmful events caused by objects set-in-motion by a Motor Vehicle in Transport, remember that a vehicle's "load" is considered part of the vehicle (see ANSI D16 definition of a Transport Vehicle). An example of this attribute would be if cargo falls from a truck (in transport) and strikes another vehicle in transport. This is treated as a two-vehicle accident where this attribute would apply as the Most Harmful Event for the vehicle struck by the load (cargo).

Work Zone / Maintenance Equipment: Equipment related to the work zone or roadway maintenance.

Clarification: *Crashes can be Work Zone Related if the first harmful event occurred outside the boundaries of the Work Zone, but the Work Zone or Equipment related to the work zone were involved in the sequence of events.*

Other Non-Fixed Object: A collision with an object other than a motor vehicle in transit, a pedestrian, another road vehicle in transit, a parked motor vehicle, a railway vehicle, a pedal cycle, an animal, or a fixed object. **Only select “Other” if none of the other listed “Non-Fixed Object” descriptions are appropriate.**

Collision with Fixed Object

Impact Attenuator / Crash Cushion: A barrier at a spot location, less than 25ft. (7.6 m) away, designed to prevent an errant motor vehicle from impacting a fixed object hazard by gradually decelerating the motor vehicle to a safe stop or by redirecting the motor vehicle away from the hazard.



Bridge Overhead Structure: Any part of a bridge that is over the reference or subject roadway. In crash reporting, this typically refers to the beams or other structural elements supporting a bridge deck.

Bridge Pier or Support: Support for a bridge structure including the ends (abutments).



Bridge Rail: A barrier attached to a bridge deck or a bridge parapet to restrain motor vehicles, pedestrians or other users.



Cable Barrier: Refers to a flexible barrier system which uses several cables typically supported by steel posts. These can be used on the roadside or as a median barrier. These barriers are designed to help lessen impact or keep vehicles within the confines of the road.



Culvert: An enclosed structure providing free passage of water under a roadway with a clear opening of less than twenty feet measured along the center of the roadway.



Curb: A raised edge or border to a roadway. Curbs may be constructed of concrete, asphalt or wood and typically have a face height of less than 9 inches.



Ditch: Developed primarily to collect and move water. It is adjacent to a highway and is usually identified as the roadside.

Embankment: Raised structures to hold back water, to carry or support a roadway, or the result of excavation or washout that may be faced with earth, rock, stone or concrete. An embankment can usually be differentiated from a wall by its incline, whereas a wall is usually vertical.



Guardrail Face: Areas along a guardrail stretch other than the ends.

Guardrail End: As in the photos below, the guardrail end is typically painted a warning color and may include a breakaway or redirection design feature not to be confused with an impact attenuator.



Concrete Traffic Barrier: Refers to the longitudinal traffic barriers constructed of concrete and located on the outside of the road surface, in a median, or in gore areas. This includes all temporary concrete barriers regardless of location (i.e., temporary barrier on a bridge being used to control traffic during bridge repair/construction).

Other Traffic Barrier: Longitudinal barriers other than guardrails, concrete traffic barriers, or cable barriers. They may be composed of material such as wood or rock.

Tree (standing): A tree that is standing and not uprooted.

Utility Pole/Light Supports: Constructed for the primary function of supporting an electric line, telephone line or other electrical-electronic transmission line or cable.

Traffic Sign Support: A pole, post or other type of support for a traffic sign.



Traffic Signal Support: A pole, post or other type of support for a traffic signal.

Fence: A fence is a freestanding structure designed to restrict or prevent movement across a boundary.



Mailbox: A Letter box, copper box, or other sturdy material compartment, mounted on a post for incoming postal deliveries.

Other Post Pole or Support: Post, pole or support that does not include a highway safety sign.

Other fixed Object (wall, building, tunnel, etc.)

Unknown: Only choose unknown when it is not known what caused the most harmful event. **This selection should not be used if the crash investigator is on scene.**

Gate or Cable: A gate or cable is a point of entry to a field, trail or fence that may prevent or control entry or exit.



Pressure Ridge: A pressure ridge is an ice formation typically found on large frozen lakes or sea ice during the winter caused by repeated heating and cooling on the surface of the lake. In cold weather, ice will shrink in volume, opening up cracks in the surface of lakes that are completely frozen over. The cracks quickly fill with water and freeze again, but when the temperature rises later, the ice expands and forces itself upward along the lines of the crack.



Person Elements

The following crash data element numbers coincide with the 13:20 Quick Reference where the data elements are identified by number on the form.

Select Person Type

45 Person Type

Select Person Type	
Person Type	
1	Driver
6	Driver/Owner
2	Passenger
8	Passenger/Owner
5	Owner
25	Last Known Operator/Owner
24	Last Known Operator

Definition: The classification of the person involved in the crash.

Rationale: Used for classification purposes to evaluate specific countermeasures designed for specific people

Special Note: An involved person in a crash should maintain Person Type during the crash. Once the unstabilized situation begins, a driver, passenger or non-motorist should not change Person Type until the crash stabilizes. If a person is entering or exiting a vehicle before the unstabilized situation begins, try to determine if the person has successfully changed type before control is lost. (i.e., a pedestrian getting into an automobile that begins to move, a passenger stepping off of a bus as it begins to pull away, etc.).

Driver: An occupant who is actual physical control of a motor vehicle or, for an out-of-control motor vehicle, an occupant who was in control until control was lost.

Passenger: Occupant of motor vehicle other than the driver of the motor vehicle.

Owner: Person listed on vehicle registration as owner or co-owner.

Driver/Owner: When person is both driver and owner

Passenger/Owner: When person is both passenger and owner.

Last Known Operator: Person who was last known to be in control of the vehicle.

Last Known Operator/Owner: When person is both last known operator and owner.

License Info

License Status



Definition: Status of operator's driver's license as listed by the Bureau of Motor Vehicles.

Active: Driver has valid operator's license.

None: Driver has no operators license.

Permit: Driver has valid operator's permit.

Suspended: Driver's operator's license is revoked.

License Number

License Number
12345

Alphanumeric identifier assigned to license holder by Bureau of Motor Vehicles.

License State

State
ME

State where operators license was issued

46 License Class

Class	End
Clear Selection	
A A	
B B	
C C	
O Other	

Definition: Class of license issued to operator regarding the type of motor vehicle the operator is qualified to drive. (**Note:** If license is from another state, the license class must be converted to the Maine license class which is most comparable). Reference Title 29-A Section 1252.

Class A: A Class A license may be issued for the operation of a combination of vehicles with a gross vehicle weight rating (GVWR) or registered weight of 26,001 or more pounds, if the gross vehicle weight rating or gross weight of the vehicles being towed is in excess of 10,000 pounds. Holders of a Class A license may, with an appropriate endorsement, operate a vehicle in Class B or C.

Class B: A Class B license may be issued for the operation of a single motor vehicle with a gross vehicle weight rating or registered weight of 26,001 or more pounds or such a vehicle towing a vehicle with a gross vehicle weight rating or gross weight not in excess of 10,000 pounds. A holder of a Class B license may, with an appropriate endorsement, operate a vehicle in Class C.

Class C: A Class C license may be issued for the operation of a single vehicle or a combination of vehicles that does not meet the definition of Class A or Class B license. A holder of a Class C license may, with an appropriate endorsement, operate all vehicles in that class.

Other: Only select “Other” if none of the other listed “License Class” descriptions are appropriate.

Endorsements

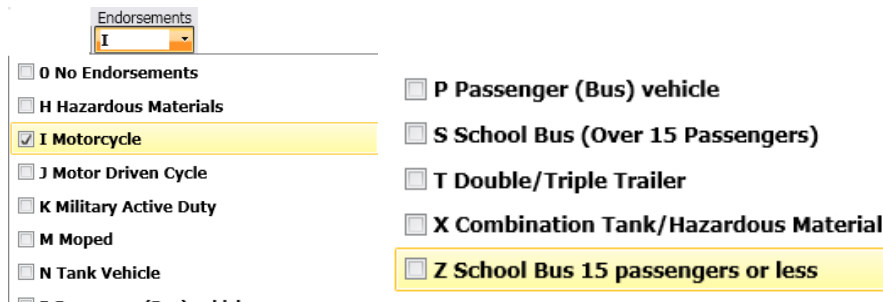

Endorsements

O No Endorsements

H Hazardous Materials

I Motorcycle

J Motor Driven Cycle

K Military Active Duty

M Moped

N Tank Vehicle

P Passenger (Bus) vehicle

S School Bus (Over 15 Passengers)

T Double/Triple Trailer

X Combination Tank/Hazardous Material

Z School Bus 15 passengers or less

Check as many special endorsements issued to the operators license.

Restrictions

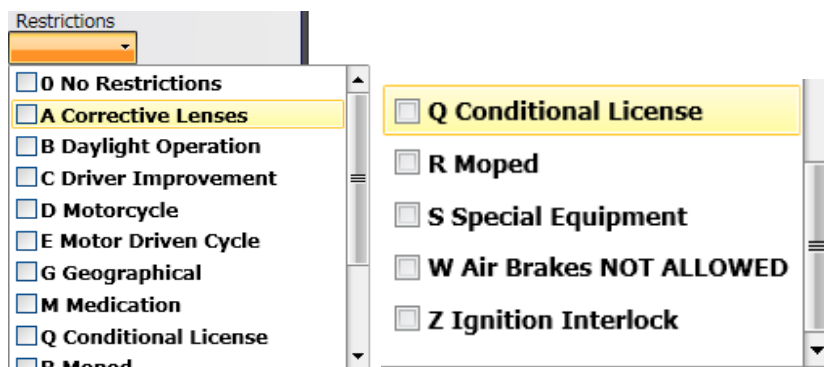

Restrictions

O No Restrictions

A Corrective Lenses

B Daylight Operation

C Driver Improvement

D Motorcycle

E Motor Driven Cycle

G Geographical

M Medication

Q Conditional License

R Moped

S Special Equipment

W Air Brakes NOT ALLOWED

Z Ignition Interlock

Check any restrictions issued to the operators license.

Name

Last Name



Last Name

Jones

Last Name of Person

First Name



First Name

David

First Name of Person

MI

Middle Initial of person

Date of Birth / Sex

Date of Birth

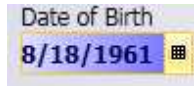

A screenshot of a date input field. The text 'Date of Birth' is at the top. Below it, the date '8/18/1961' is entered in a blue box. To the right of the date is a small calendar icon.

Birth date of person (MMDDYY)

Sex



A screenshot of a dropdown menu for 'Sex'. The menu is open, showing three options: '1 Male' (highlighted in yellow), '2 Female', and '3 Unknown'. Above the menu, the text 'Sex' is visible, and a small arrow icon points down.

Sex of person

Address

47 Address

Physical Address of person involved

Note: This is the location of the person's dwelling, not mailing address or Post Office box

City

City/Town where the person resides

State

State where the person resides

Zip Code

Five digit zip code of the city/town where person resides

Citation and Violations

48 Citation

If a Violations Summons and Complaint was issued as a result of the crash, enter the citation number here.

Citation Pending

Check this box if a citation is pending as a result of circumstances surrounding the crash

Violation 1

Violation 1 Violation 2

Clear Selection

- 17-2263-A-1E1 Operator littering from a vehicle
- 17-2263-A-1E2 Littering from a vehicle
- 23-1980-1 Operating below minimum turnpike speed limit
- 23-1980-10-01 Operating over limit vehicle on turnpike without permit
- 23-1980-10-2 Op beyond license restrictions
- 23-1980-11 Operating with radioactive materials without a permit
- 23-1980-1B Operating truck/truck tractor beyond lane restriction
- 23-1980-2 Op wrong way on divided way on turnpike
- 23-1980-3 Unnecessary stopping on turnpike

Select the appropriate violation from the drop down menu

Violation 2

If a second violation is cited, select from drop down menu

Driver Actions

49 Driver Distracted By

Clear Selection

- 1 Not Distracted
- 2 Electronic Communication Devices (Cell Phone, Pager, etc.)
- 3 Other Electronic Devices (Navigation Device, Palm Pilot, Entertainment Device, etc.)
- 4 Other Inside the Vehicle (Eating, Reading, Grooming, Smoking, Passengers, etc.)
- 5 External Distraction (outside the vehicle)
- 6 Unkown

Definition: Distractions which may have influenced the driver performance. The distractions can be inside the motor vehicle (internal) or outside the motor vehicle (external).

Rationale: Important for evaluating the effect that driver behavior has on crashes.

Not Distracted: Driver distraction was not a factor in the crash.

Electronic Communication Devices (Cell Phone, Pager, etc.): Devices enabling the driver and/or occupants of the vehicle to communicate with others not located in the vehicle.

Other Electronic Devices (Navigation Device, Palm Pilot, Entertainment Device, etc.): Includes devices that are part of the vehicle such as radio and mobile data terminal.

Other Inside the Vehicle (Eating, Reading, Grooming, Smoking, Passengers, etc.):

External Distraction (outside the vehicle) Any person, object, or event outside the vehicle that draws the operators attention (traffic crash in other lane, highway signs, pedestrians, etc).

Unknown: Select unknown if it is uncertain as to whether or not a distraction influenced the driver's performance that contributed to the crash.

50 **Condition at Time of Crash**

- 1 Apparently Normal
- 2 Physically Impaired or Handicapped
- 3 Emotional(Depressed, Angry, Disturbed, etc.)
- 4 Ill (Sick)
- 5 Asleep or Fatigued
- 6 Under the Influence of Medications/Drugs/Alcohol
- 7 Other

Definition: Any relevant condition of the individual (motorist or non-motorist) that is directly related to the crash.

Rationale: Important for evaluating the effect that fatigue, medications/alcohol/drugs/ or other conditions have on crashes.

Apparently Normal: The individual did not display any physical condition which appeared to contribute to the crash.

Physically Impaired or Handicapped: A condition that results in some decrease in a physical ability.

Emotional (Depressed, Angry, Disturbed, Road Rage, etc.): Includes; fighting, disagreements, emotionally upset, road rage, etc.

Ill (sick): Would include diabetic reactions, allergic reactions, failure to take required medications, seizures, heart attack, high/low blood pressure etc.

Asleep or Fatigued: Fatigued not due to other factors such as drugs, alcohol or being ill.

Under the Influence of Medications/Drugs/Alcohol: Suspected of being under the influence of alcohol or drugs. This includes any legal prescription drug or over-the-counter medication such as cough syrup, as well as illegal drugs of any type.

Other: Any other physical or mental condition which may have contributed to the crash.

Driver Actions at Time of Crash 1

Definition: The actions by the driver that may have contributed to the crash. This data element is based on the judgment of the law enforcement officer investigating the crash and need not match Violation Codes.

Rationale: Important for evaluating the effect that dangerous driver behavior has on crashes.

No Contributing Action: The driver operated motor vehicle in an apparently correct manner.

Ran Off Roadway: The driver Failed to keep the motor vehicle on the roadway.

Failed to Yield Right of Way: The driver failed to yield right-of-way to another motor vehicle or non-occupant as required.

Ran Red Light: The driver continues through an intersection shortly after the light turns red.

Ran Stop Sign: The driver fails to obey a stop sign.

Disregarded Other Traffic Sign: Failing to obey traffic signs, such as yield signs, and other regulatory or advisory signs. This does not include exceeding the posted speed limit or advisory speed.

Disregarded Other Road Markings: The driver failed to obey other painted roadway marking such as crosswalk, turn lane etc.

Exceeded Posted Speed Limit: This code should be used when a vehicle was exceeding the legal speed limit. The legal limit is **NOT** to be construed as advisory speed limits such as those posted on curve signs or flashing during inclement weather.

Drove Too Fast for Conditions: Traveling at a speed that was unsafe for the road, weather, traffic or other environmental conditions at the time.

Improper Turn: An illegal or improperly executed turn or U-turn; e.g., disregarding a NO TURN sign, making a U-turn in a NO U-TURN zone or without proper traffic clearance, turning from the wrong lane, etc. This does not include right-of-way violations when a proper turn is made.

Improper Backing: Any vehicular backing maneuver that is not legal or proper under the given driving circumstances and/or location.

Improper Passing: Any illegal or improper maneuver by which one vehicle passes another moving vehicle; e.g., crossing double yellow lines, passing within a NO PASSING zone, passing without assured traffic clearance, etc.

Wrong Way: Any situation in which the driver is operating a vehicle within an opposing traffic lane. This does not include improper passing or failing to keep in proper lane. Wrong Way is for driving the wrong direction on a one-way roadway or the wrong way on a divided traffic way.

Followed Too Closely: The driver was positioned at a distance behind another motor vehicle or non-occupant that was too close to permit safe response to any change in movement or behavior by the other motor vehicle or non-occupant.

Failed to Keep in Proper Lane: The driver did not maintain position in appropriate travel lane.

Operated Motor Vehicle in Erratic, Reckless, Careless, Negligent or Aggressive Manner: The driver operated in such a manner that would pose unnecessary risk to himself or other people/vehicles.

Swerved or Avoided due to Wind, Slippery Surface, Motor Vehicle, Object, Non-Motorist in Roadway: Defensive driver action to defend against an apparent danger in, on, or due to the condition of the roadway or the presence of a motor vehicle or object or non-motorist in the roadway in order to avoid a crash.

Over-corrected/ Over-steered: A steering maneuver which is too sharp or severe for the driving conditions or travel speed. This is **Not** improper turning.

Other Contributing Action: Some examples would be failure of the driver to properly signal his/her intentions or failure to maintain posted legal minimum speed. **Only select “Other” if none of the other listed “Driver Actions at Time of Crash” descriptions are appropriate.**

Unknown: Choose unknown when it is not known what the Driver Actions were at the time of the crash.

Driver Actions at Time of Crash 2

If a second driver action also contributed to the crash, select it here. This section does not need to be filled in. If you selected No Improper Action under Primary Contributing Factor, **DO NOT** select a secondary Driver Action here.

Alcohol

52 Alcohol Test

The screenshot shows a software interface for an 'Alcohol Test'. At the top, there is a dropdown menu currently set to 'Test Not Given' and a checkbox labeled 'Result Pending'. Below this is a 'Clear Selection' button. The main dropdown menu is open, showing a list of options: '1 Test Not Given' (highlighted in yellow), '2 Test Refused', '4 Blood', '5 Breath', '7 Urine', and '8 Other Chemical Test (Not Field Sobriety or PBT)'. The window title is 'Alcohol Test' and there is a 'BAC' label in the top right corner.

Definition: Indication of the presence of alcohol by test, type and result.

Rationale: Alcohol remains the most prevalent drug involved in motor vehicle crashes. Capturing alcohol concentration whenever a driver or non-motorist is tested will provide an accurate assessment of the role of alcohol involvement. The type of test used to obtain the alcohol. Concentration is also important information to collect.

Test Not Given: No test was administered to the operator.

Test Refused: Probable cause to administer test but refused by the operator.

Blood: Also called "Whole" blood test where blood is drawn to be tested.

Breath: Includes evidential breathalyzer or a Pre-Arrest Breath Test (PBT).

Urine: Where urine is collected to be tested.

Other Chemical Test (Not Field Sobriety or PBT): Would include post mortem collection of vitreous (fluid from eye), liver and blood plasma.

53 Result Pending

Check this box if test was administered and the result is pending.

BAC Result

Enter the result of the Alcohol test here.

Drugs

54 Drug Test

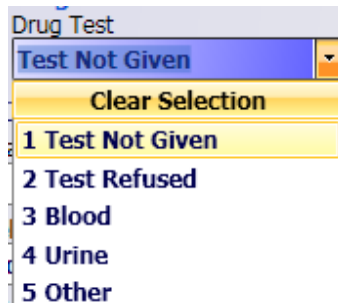

Drug Test

Test Not Given

Clear Selection

1 Test Not Given

2 Test Refused

3 Blood

4 Urine

5 Other

Definition: Indication of the presence of drug test, type and result. Excludes drugs administered post-crash. See Drug Test Result to document drug name and value. An example of drugs administered post crash would be pain killers given by paramedics.

Rationale: Identifying drug-related crashes helps to develop and evaluate programs directed at reducing their involvement. Whenever evidence of other drug use is available, it should be captured.

Test Not Given: No test was given to the operator as a result of the crash.

Test Refused: Probable cause to administer test but refused by the operator.

Blood: Also called “Whole” blood test where blood is drawn to be tested.

Urine: Urine is collected to be tested.

Other: Would include post mortem collection of vitreous (fluid from eye), liver and blood plasma. This would **Not** include Field Sobriety or PBT test.

55 Drug Test Result

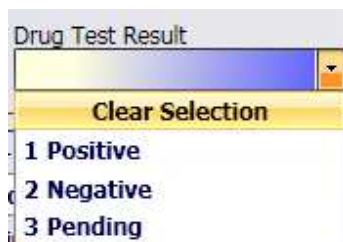

Drug Test Result

Positive

Clear Selection

1 Positive

2 Negative

3 Pending

Occupant Details

56 Seat Row

The screenshot shows a software interface with two dropdown menus. The first dropdown, labeled 'Seat Row', is currently set to 'Front Row'. The second dropdown, labeled 'Seat Position', is currently set to 'Left (driver for)'. Below these dropdowns is a 'Clear Selection' button. A list of options for the 'Seat Row' dropdown is displayed, including '1 Front Row', '2 Second Row', '3 Third Row', '4 Fourth Row', '5 Other Row (bus, 15 passenger van, etc.)', and '6 Unknown'. The '6 Unknown' option is highlighted in yellow.

Definition: The location for this occupant in the motor vehicle prior to the first event in the Sequence of Events.

Rationale: Without known seating position of each person in the motor vehicle, it is not possible to fully evaluate, for example, the effect of occupant protection programs.

Front Row: The seating position of the person being documented is in the front row of the vehicle.

Second Row: The seating position of the person being documented is in the second row of the vehicle.

Third Row: The seating position of the person being documented is in the third row of the vehicle.

Fourth Row: The seating position of the person being documented is in the fourth row of the vehicle.

Other Row: (bus, 15 passenger van, etc.):

Unknown: Only select “Unknown” if the “Seat Row” is unknown by the investigating officer.

Seat Position

Seat Position Seat I
Left (driver for most vehi
Clear Selection
1 Left (driver for most vehicles)
2 Middle
3 Right
4 Other
5 Unknown

Definition: The location in respect to seat position for this occupant in, on, or outside of the motor vehicle prior to the first event in the Sequence of Events.

Left (driver for most vehicles): The person is in the left seat of the vehicle.

Middle: The person is in the middle seat of the vehicle.

Right: The person is located in the right seat of the vehicle.

Other: Only select “Other” if none of the other listed “Seat Position” descriptions are appropriate.

Unknown: Only select “Unknown” if the “Seat Position” is unknown by the investigating officer.

Seat Position Other

Seat Position Other Air Bag Deployed
Not Deployed
Clear Selection
1 Sleeper Section of Cab (truck)
2 Other Enclosed Cargo Area
3 Unenclosed Cargo Area
4 Trailing Unit
5 Riding on Motor Vehicle Exterior (non-trailing unit)
6 Unknown

Definition: The seat position if the occupant was not located in the conventional passenger area of the vehicle prior to the crash.

Sleeper Section of Cab (truck): If the occupant was in the sleeper berth area of a truck tractor prior to the crash

Other Enclosed Cargo Area: Any other enclosed area of the vehicle not designed to be a passenger seat while the vehicle is in transit (living area of a motor home). This does not include a unit being towed.

Unenclosed Cargo Area: Any open area of the vehicle not designed to be a passenger seat while the vehicle is in transit (bed of pickup). This does not include a unit being towed.

Trailing Unit: If the occupant was in a towed unit (trailer/semi-trailer) at the time of the crash

Riding on Motor Vehicle Exterior (non-trailing unit): If the occupant was positioned on the exterior of a motor vehicle in transit at the time of the crash.

Unknown: Only select “Unknown” if none of the other listed “Seat Position Other” descriptions are appropriate.

57 Air Bag Deployed

Air Bag Deployed
Not Deployed
Clear Selection
1 Not Applicable
2 Not Deployed
3 Deployed - Front
4 Deployed - Side
5 Deployed - Other (knee, air belt,...)
6 Deployed - Combination
7 Deployment - Curtain

Definition: Deployment status of an air bag relative to the position in the vehicle for this occupant.

Rationale: Necessary to evaluate the effectiveness of air bags and other occupant protection equipment, especially at a time when air bags are becoming standard equipment.

Not Applicable: This attribute would apply to any person who is:

- Not an occupant of a vehicle in transport (non-motorists).
- Occupants in seating positions that are not equipped with an air bag in vehicles that have air bags in some seat positions.
- Every seating position in vehicles that do not come equipped with air bags in any position (Examples are; motorcycles, early model passenger cars, some medium-heavy trucks and buses.).
- Identifies an air bag system that has been rendered inoperative (switched off) either intentionally or inadvertently during maintenance or an air bag previously deployed or removed that has not been replaced.

Not Deployed: An available air bag for any seat position that is not deployed out of its cover and protruding into driver compartment.

Deployed - Front: Air bag for the driver or front seat passenger is deployed out of its cover and protruding into driver compartment.

Deployed - Side: Air bag on side of a motor vehicle is deployed out of its cover and protruding into occupant compartment.

Deployed – Other (knee, air belt, etc.): A knee air bag, air belt, or other air bag technology is deployed.

Deployed – Combination: More than one air bag deploys, including front and side, front and other, side and other, or front, side and other, etc.

Deployment – Curtain: Curtain air bag is out of its cover and protruding into driver or passenger compartment.

Ejected



The image shows a screenshot of a software interface. At the top, the word "Ejected" is displayed in a blue box. Below it is a dropdown menu with a blue header containing the text "Not Ejected" and a small downward-pointing arrow on the right. Underneath the header is a button labeled "Clear Selection". The dropdown menu is open, showing three options: "1 Not Ejected", "2 Ejected Partially", and "3 Ejected Totally". The option "2 Ejected Partially" is highlighted in yellow.

Definition: Occupant completely or partially thrown from the interior of the motor vehicle, excluding motorcycles, as a result of a crash.

Rationale: Occupant protection systems prevent or mitigate ejections to various degrees. Analyses of the effectiveness of safety belts depend on information from this data element.

Not Ejected: The occupant remained in the vehicle during the crash, and until post crash momentum had ceased.

Ejected Partially: The occupant's body was partially out of the vehicle when post crash momentum had ceased. Partial penetration may be through windshield, doors (open or closed), or the roof.

Ejected Totally: The occupant's body was thrown out of the vehicle during the crash or before post crash momentum had ceased. No part of the body remained in the vehicle.

Restraint System

Restraint System	Helmet Use
Shoulder and Lap Belt Us	No Helmet
Clear Selection	
1 Not Applicable	
2 None Used - Motor Vehicle Occupant	
3 Shoulder and Lap Belt Used	
4 Shoulder Belt Only Used	
5 Lap Belt Only Used	
6 Restraint Used - Other	
7 Child Restraint System - Forward Facing	
8 Child Restraint System - Rear Facing	
9 Child Restraint System - Used Incorrectly	

Definition: The restraint equipment in use by the occupant at the time of the crash.

Rationale: Proper classification of the use of available occupant restraint systems is vital to evaluating the effectiveness of such equipment.

Not Applicable: This attribute would apply to persons whose position in or on a vehicle does not have a restraint system.

None Used – Motor Vehicle Occupant: Any occupant of the motor vehicle (driver, passenger) that did not use an available restraint.

Shoulder and Lap Belt Used: Use of occupant restraint system where both the shoulder belt and lap belt portions are connected to a buckle.

Shoulder Belt Only Used: In a two-part occupant restraint system, only the shoulder belt portion connected to a buckle is used.

Lap Belt Only Used: Use of only a lap safety belt either because the motor vehicle is equipped only with a lap belt or because the shoulder belt is not in use.

Restraint Used – Other: Only select “Other” if none of the other listed “Restraint” descriptions are appropriate.

Child Restraint System – Forward Facing: Child passenger faces forward in the child restraint system. This does not imply correct use or placement but requires the child to be buckled into the safety seat.

Child Restraint System – Rear Facing: Child passenger faces the rear in the child restraint system. This does not imply correct use or placement but requires the child to be buckled into the safety seat.

Child Restraint System – Used Incorrectly: A child restraint system that is not designed for the weight/size of the child, or is not adequately secured to the vehicle

Booster Seat: A "belt-positioning seat" that positions a child on a vehicle seat to improve the fit of the lap and shoulder seat belt system. This seat is recommended for children who weigh 40 pounds or more.

Child Restraint System – Other: Only select “Child Restraint System - Other” if none of the other listed “Child Restraint System” descriptions are appropriate.

59 **Helmet Use**

Helmet Use	Injury Deg
No Helmet	No Injur
Clear Selection	
1 DOT-Compliant Motorcycle Helmet	
2 Other Helmet	
3 No Helmet	

Definition: The Helmet in use by the motorcycle operator or passenger at the time of the crash

Rationale: Proper classification of helmet use is vital to evaluating the effectiveness of such equipment.

DOT – Compliant Motorcycle Helmet: Motorcycle helmets that are compliant with Federal Motor Vehicle Safety Standards typically weigh approximately 3 pounds, have an inner liner at least one-inch thick of firm polystyrene foam, have an inside label that states the manufacturer, model, and date of manufacture, and have a DOT sticker on the back of the helmet.

Other Helmet: Helmet worn that does not meet DOT standards

No Helmet: No helmet worn

60 **Injury Degree**

Injury Degree
No Injury
Clear Selection
1 Fatal
2 Incapacitating
3 Non-Incapacitating
4 Possible Injury
5 No Injury

Definition: The injury severity level for a person involved in a crash.

Rationale: Necessary for injury outcome analysis and evaluation. It is also critical in providing linkage between the crash, EMS, and hospital records.

Fatal: Any injury that results in death *within a 30 day period* after the crash occurred.

Incapacitating: Any injury, other than a fatal injury, which prevents the injured person from walking, driving or normally continuing the activities the person was capable of performing before the injury occurred. Often defined as needing help from the scene.

Non-Incapacitating: Any injury, other than a fatal injury or an incapacitating injury, which is evident to observers at the scene of the crash in which the injury occurred. *Examples: Contusions (bruises), laceration, bloody nose.*

Possible Injury: Complaint of pain without visible injury. Includes momentary unconsciousness, claim of injuries not evident, limping, complaint of pain, nausea, hysteria.

No Injury: No injuries resulted from the crash.

61 Injury Type



Definition: Indicate the most severe injury of person

Amputation: The accidental loss of a limb or body part.

Bleeding: The release of blood from the vascular system as a result of damage to a blood vessel or artery.

Broken Bones: A medical condition in which a bone is cracked or broken. It is a break in the continuity of the bone.

Burns: Injuries to tissues caused by heat, friction, electricity, radiation, or chemicals.

Concussion: A trauma-induced change in mental status, with confusion and amnesia, and with or without a brief loss of consciousness.

Shock: A medical emergency in which the organs and tissues of the body are not receiving an adequate flow of blood.

Dizziness: A disturbed sense of relationship to space; a sensation of unsteadiness and a feeling of movement within the head; lightheadedness; dysequilibrium.

Abrasion/Bruises: Abrasion - A scraping or rubbing away of the skin. Bruise - An injury to underlying tissues or bone in which the skin is unbroken, often characterized by ruptured blood vessels and discolorations; a contusion.

Complaint of Pain: Person complains of generalized pain as a result of the crash.

Other: Only select “Other” if none of the other listed “Injury Type” descriptions are appropriate.

62 Injury Area

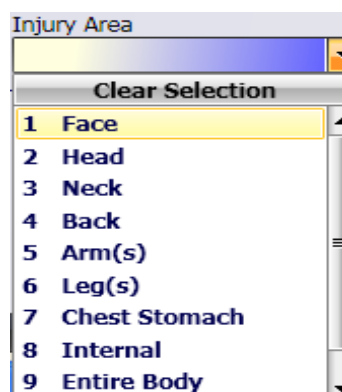

Definition: Indicate the area on the person’s body that sustained the most significant injury.

Select the appropriate area from the drop down menu.

Other: Only select “Other” if none of the other listed “Injury Area” descriptions are appropriate.

63 Injury Info Source

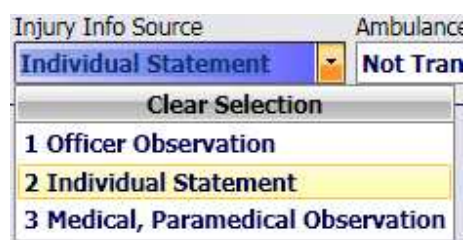

Definition: Person who made observation regarding injury type and degree.

The officer should select the source from where the injury information was obtained (it is suggested the source be either from the individual or a trained emergency medical provider).

Officer Observation: Officer completing crash report observed injuries.

Individual Statement: Individual who was injured made statement to officer.

Medical, Paramedical Observation: Medical personnel treating individual made statement.

Ambulance Code

Identity of ambulance unit providing transport of the patient to the receiving medical facility. If an ambulance responds to the scene, even if a patient was not transported, it should be documented by the officer in the ambulance code field. Only one ambulance code can be selected.

Pedestrians/Bicycle Elements

Definition: A collision with a person who is not an occupant of a motor vehicle in transport. Includes a person who is adjacent to the motor vehicle regardless of his/her actions. Pedestrian crashes include any collision between a **motor vehicle and a person on foot in or alongside of the road**. This person may be walking, pushing a bicycle or pulling a wagon or sled, or in the process of changing a tire on a disabled vehicle.

Pedestrian Inclusions:

- *A person changing a tire is struck by a passing motor vehicle.*
- *A bicyclist walking his/her bike across an intersection is struck by a motor vehicle*
- *A person walking a horse is struck by a passing motor vehicle*

Pedestrian Exclusions

- *A disabled vehicle is struck in the rear while a person is changing a tire. The pedestrian is struck as a result of the collision. This type crash would be coded “rear end/sideswipe”.*
- *A horse is struck while being ridden on the side of the road. This type crash would be coded “anima”.*
- *A person is struck while riding a bicycle on the roadside. This type crash would be coded “bicycle”.*

Bicyclist: Any persons (operator and passengers) operating a unicycle, two-wheel, or three-wheel non-motorized cycle.

Name

Name		
Last Name	First Name	MI

The pedestrian's name should be listed as Last Name, First Name, MI

Date of Birth / Sex

Date of Birth / Sex	
Date of Birth	Sex
1/1/1980	Male

Enter digitally the date of birth as MM/DD/YY.

Sex: Select from the appropriate sex from the drop down list. Choose Male, Female or Unknown. You may also utilize the “type ahead” feature by selecting the “M”, “F” or “U” key.

Address

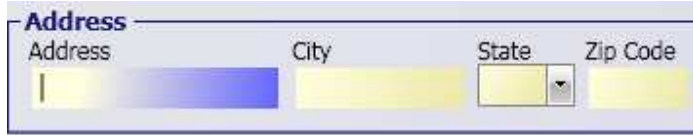

The screenshot shows a form titled "Address" with four input fields: "Address", "City", "State", and "Zip Code". The "State" field is a dropdown menu. The "Address" field is highlighted with a blue bar.

The address field should be entered as the *Physical* Address, City, State and Zip Code. The “State” field is a drop down menu and you may utilize the “type ahead” feature by selecting the first one or two letters of the two-letter state abbreviation.

Citation and Violations



The screenshot shows a form titled "Citation and Violations" with four input fields: "Citation", "Citation Pending" (checkbox), "Violation 1", and "Violation 2". The "Violation 1" and "Violation 2" fields are dropdown menus.

If there is a citation or violation issued to the pedestrian the officer should complete this field and choose from the drop down list in the violations field. Up to two violations can be shown for the pedestrian. If a citation is pending the check box should be checked.

Alcohol

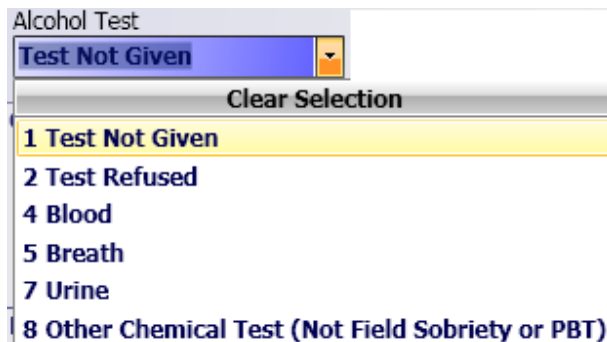

The screenshot shows a dropdown menu titled "Alcohol Test" with the following options: "Test Not Given", "Clear Selection", "1 Test Not Given", "2 Test Refused", "4 Blood", "5 Breath", "7 Urine", and "8 Other Chemical Test (Not Field Sobriety or PBT)".

Definition: Indication of the presence of alcohol by test, type and result.

Rationale: Alcohol remains the most prevalent drug involved in motor vehicle crashes. Capturing alcohol concentration whenever a driver or non-motorist is tested will provide an accurate assessment of the role of alcohol involvement. The type of test used to obtain the alcohol. Concentration also is important information to collect.

Test Not Given: No test was administered to the operator.

Test Refused: Probable cause to administer test but refused by operator

Blood: also called “Whole” blood test where blood is drawn to be tested

Breath: Includes evidential breathalyzer or a Pre-Arrest Breath Test (PBT)

Urine: Where urine is collected to be tested

Other Chemical Test (Not Field Sobriety or PBT): Would include post mortem collection of vitreous (fluid from eye), liver and blood plasma.

If the test results are pending the officer should select the ‘Results Pending’ box.

If the test results are known the officer should enter the Blood Alcohol Content (BAC) results in the following number range (0.00-1.00).



Alcohol Test

Alcohol Test

Result Pending

BAC Result

###.###

Drugs

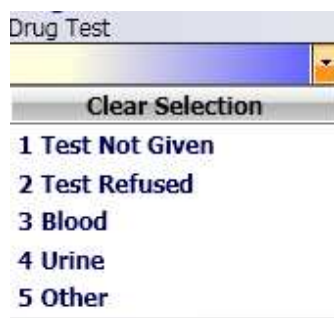

Drug Test

Clear Selection

- 1 Test Not Given
- 2 Test Refused
- 3 Blood
- 4 Urine
- 5 Other

Definition: Indication of the presence of drug test, type and result. Excludes drugs administered post-crash. See Drug Test Result to document drug name and value. An example of drugs administered post crash would be pain killers given by paramedics.

Rationale: Identifying drug-related crashes helps to develop and evaluate programs directed at reducing their involvement. Whenever evidence of other drug use is available, it should be captured.

Test Not Given: No test was given to the operator as a result of the crash.

Test Refused: Probable cause to administer test but refused by operator.

Blood: Also called “Whole” blood test where blood is drawn to be tested.

Urine: Urine is collected to be tested.

Other Chemical Test (Not Field Sobriety or PBT): Would include post mortem collection of vitreous (fluid from eye), liver and blood plasma.

Drug Test Result

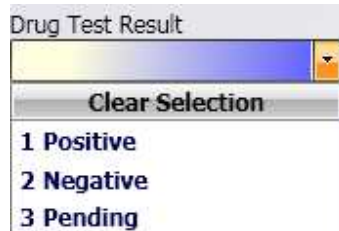

Drug Test Result

Clear Selection

- 1 Positive
- 2 Negative
- 3 Pending

If a drug test is given the officer should select 'positive or negative' if the results are known and 'pending' if the results are unknown.

Occupant Details

Helmet Use (Bicycle)



Helmet Use

Clear Selection

- 1 DOT-Compliant Motorcycle Helmet
- 2 Other Helmet
- 3 No Helmet

Definition: The safety equipment(s) used by the non-motorist.

Rationale: Proper classification of the use of available occupant restraint systems and helmet use is vital to evaluating the effectiveness of such equipment.

DOT-Compliant Motorcycle/Bicycle Helmet: Motorcycle/Bicycle helmets that are compliant with Federal Motor Vehicle Safety Standards typically weigh approximately 3 pounds, have an inner liner at least one-inch thick of firm polystyrene foam, have an inside label that states the manufacturer, model, and date of manufacture, and have a DOT sticker on the back of the helmet.

Other Helmet: Helmet worn that does not meet DOT standards.

Injury Degree



Injury Degree

Clear Selection

- 1 Fatal
- 2 Incapacitating
- 3 Non-Incapacitating
- 4 Possible Injury
- 5 No Injury

Definition: The injury severity level for a person involved in a crash.

Rationale: Necessary for injury outcome analysis and evaluation. It is also critical in providing linkage between the crash, EMS, and hospital records.

The officer should select the most appropriate degree of injury for the pedestrian.

Fatal: Any injury that results in death within a 30 day period after the crash occurred.

Incapacitating: Any injury, other than a fatal injury, which prevents the injured person from walking, driving or normally continuing the activities the person was capable of performing before the injury occurred. Often defined as needing help from the scene

Inclusions:

- *Severe laceration*
- *Broken or distorted limb*
- *Skull or chest injury*
- *Abdominal injury*
- *Unconsciousness at or when taken from the crash scene*
- *Unable to leave the accident scene without assistance*

Exclusions:

- *Momentary unconsciousness*

Non-Incapacitating: Any injury, other than a fatal injury or an incapacitating injury, which is evident to observers at the scene of the crash in which the injury occurred.

Inclusions:

- *Lump on head, abrasions, bruises, minor lacerations*

Exclusions:

- *Limping (the injury cannot be seen)*

Possible Injury: Complaint of pain without visible injury

Inclusions:

- *Momentary unconsciousness*
- *Claim of injuries not evident*
- *Limping, complaint of pain, nausea, hysteria*

No Injury: No visible injury and no complaint of pain

Injury Type



The officer should select the most severe injury.

Amputation: The accidental loss of a limb or body part.

Bleeding: The release of blood from the vascular system as a result of damage to a blood vessel or artery.

Broken Bones: A medical condition in which a bone is cracked or broken. It is a break in the continuity of the bone.

Burns: Injuries to tissues caused by heat, friction, electricity, radiation, or chemicals.

Concussion: A trauma-induced change in mental status, with confusion and amnesia, and with or without a brief loss of consciousness.

Shock: A medical emergency in which the organs and tissues of the body are not receiving an adequate flow of blood.

Dizziness: A disturbed sense of relationship to space; a sensation of unsteadiness and a feeling of movement within the head; lightheadedness; dysequilibrium.

Abrasion/Bruises: Abrasion - A scraping or rubbing away of the skin. Bruise - An injury to underlying tissues or bone in which the skin is unbroken, often characterized by ruptured blood vessels and discolorations; a contusion.

Complaint of Pain: Person complains of generalized pain as a result of the crash.

Other: Only select “Other” if none of the other listed “Injury Type” descriptions are appropriate.

Injury Area



The screenshot shows a dropdown menu titled "Injury Area". The menu is open, displaying a list of options: 1 Face, 2 Head, 3 Neck, 4 Back, 5 Arm(s), 6 Leg(s), 7 Chest Stomach, 8 Internal, and 9 Entire Body. Above the list is a "Clear Selection" button. The menu has a blue header bar and a scroll bar on the right side.

The officer should select the area where the most severe injury occurred.

Injury Info Source

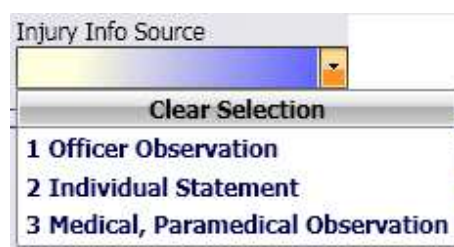

The screenshot shows a dropdown menu titled "Injury Info Source". The menu is open, displaying a list of options: 1 Officer Observation, 2 Individual Statement, and 3 Medical, Paramedical Observation. Above the list is a "Clear Selection" button. The menu has a yellow header bar and a scroll bar on the right side.

The officer should select the source from where the injury information came from. (It is suggested the source be either from the individual of a trained emergency medical provider).

Officer Observation: Officer completing crash report observed injuries

Individual Statement: Individual who was injured made statement to officer

Medical, Paramedical Observation: Medical personnel treating individual made statement

Ambulance Code

If an ambulance responded to the scene, even if a patient was not transported it should be documented by the officer in the ambulance code field. Only one ambulance department can be selected.

Non Motorist Details (Pedestrian/Bicyclists)

Condition at Time of Crash

Condition at Time of Crash

Clear Selection

- 1 Apparently Normal
- 2 Physically Impaired or Handicapped
- 3 Emotional(Depressed, Angry, Disturbed, etc.)
- 4 Ill (Sick)
- 5 Asleep or Fatigued
- 6 Under the Influence of Medications/Drugs/Alcohol
- 7 Other

Definition: Any relevant condition of the individual (non-motorist) that is directly related to the crash.

Rationale: Important for evaluating the effect that fatigue, medications/alcohol/drugs/other conditions have on the crash.

Physically Impaired of Handicapped: A condition that results in some decrease in a physical ability.

Emotional(Depressed, Angry, Disturbed, etc.): Includes; fighting, disagreements, emotionally upset, road rage, etc.

Ill (Sick): Would include diabetic reactions, allergic reactions to medications/drugs, failure to take required medication, seizures, heart attack, high/low blood pressure.

Asleep or Fatigued: Asleep at the wheel not due to other factors such as drugs, alcohol, or being ill.

Under the Influence of Medications/Drugs/Alcohol: Suspected of being under the influence of alcohol or drugs. This includes any legal prescription drug or over-the-counter medication such as cough syrup as well as illegal drugs of any type.

Location at Time of Crash

Location at Time of Crash

Clear Selection

- 1 Intersection – Marked Crosswalk
- 2 Intersection – Unmarked Crosswalk
- 3 Intersection – Other
- 4 Midblock – Marked Crosswalk
- 5 Travel Lane – Other Location
- 6 Bicycle Lane
- 7 Shoulder/Roadside
- 8 Sidewalk
- 9 Median/Crossing Island

Definition: The location of the non-motorist with respect to the roadway at the time of the crash.

Rationale: The development of effective roadway design and operation, education, and enforcement measures to accommodate pedestrians and cyclists and prevent crashes with motor vehicles is enhanced by the collection of the location of the non-motorist at the time of crash.

Intersection - Marked Crosswalk:



An area which:

1. Contains a crossing or connection of two or more roadways
2. Is embraced within the prolongation of the lateral curb lines, or, if none, the lateral boundary lines of the roadways.
3. And has a portion of the roadway distinctly indicated for pedestrian crossing by lines or other markings on the surface of the roadway.

Intersection – Unmarked Crosswalk:



An area which:

1. Contains a crossing or connection of two or more roadways
2. Is embraced within the prolongation of the lateral curb lines, or, if none, the lateral boundary lines of the roadways.

That is does not contain an area designated for pedestrian traffic.

Intersection – Other: Only select “Intersection - Other” if none of the other listed “Location at the time of the Crash” descriptions are appropriate.

Midblock - Marked Crosswalk: A portion of the roadway, not at an intersection, that is distinctly indicated for pedestrian crossing by lines or other markings on the surface of the roadway.



Travel Lane – Other Location: Only select “Travel Lane – Other Lactation” if none of the other listed “Location at the time of the Crash” descriptions are appropriate.

Bicycle Lane: Any road, path, or way which is specifically designated as being open to bicycle travel regardless of whether such facilities are designated for the exclusive use of bicycles (Dedicated Bike Lane).

Shoulder/ Roadside:

Shoulder: That part of a trafficway contiguous with the roadway for emergency use, or accommodation of stopped motor vehicles, and lateral support of the roadway structure.

Roadside: From the property line of the outermost part of the trafficway to the edge of the first road.



Sidewalk: A paved, cement or aggregate stone walkway designated for pedestrian traffic

Median/Crossing Island: An area of trafficway between parallel roads separating travel in opposite directions. A median should be four or more feet wide.



Island: Cement or grassy area in the middle of a trafficway with no designated area for non-motorist traffic.



Driveway Access: A driveway access is a portion of the trafficway at the end of a driveway providing access to property adjacent to a trafficway.

Shared-Use Path or Trail: A bikeway physically separated from motorized vehicular traffic by an open space or barrier and either within the highway right-of-way or an independent right-of-way. Shared use paths will also be used by pedestrians, skaters, wheelchairs, joggers and other non-motorized users.



Non-Trafficway Area: Not physically located on any land way open to the public as a matter of right or custom for moving persons or property from one place to another.

Other: Only select “Other” if none of the other listed “Location at the time of the Crash” descriptions are appropriate.

Unknown: Only select “Unknown” when the “Location at the time of the Crash” is unknown.

65 Action Prior to Crash

Definition: The action of the non-motorist immediately prior to the crash and an indication of whether the non-motorist was walking/cycling to/from school. Non-motorist - any person other than an occupant of a motor vehicle in transport. This includes pedestrians, bicyclists, other cyclists, occupants of other motor vehicles not in transport, and occupants of transport vehicles other than motor vehicles.

Rationale: The development of effective roadway design and operation, education, and enforcement measures to accommodate pedestrians and bicyclists and prevent crashes with motor vehicles is enhanced by the collection of the actions and circumstances prior to the crash.

Note: The attributes "Going to or from School (K-12)" and "Working in Trafficway (Incident Response)" take precedence when more than one attribute is applicable.

Action at Time of Crash 1 and 2

Action at Time Of Crash 1

Clear Selection

- 1 No Improper Action
- 2 Dart/Dash
- 3 Failure to Yield Right-Of-Way
- 4 Failure to Obey Traffic Signs, Signals, or Officer
- 5 In Roadway Improperly (Standing, Lying, Working, Playing)
- 6 Disabled Vehicle Related (Working on, Pushing, Leaving/Approaching)
- 7 Entering/Exiting Parked/Standing Vehicle
- 8 Inattentive (Talking, Eating, Etc.)
- 9 Not Visible (Dark Clothing, No Lighting, Etc.)
- 10 Improper Turn/Merge
- 11 Improper Passing
- 12 Wrong-Way Riding or Walking
- 13 Other
- 14 Unknown

There are fields for up to two actions at the time of the crash. At least one field needs to be completed by the officer.

Definition: The actions/circumstances of the non-motorist that may have contributed to the crash. This data element is based on the judgment of the law enforcement officer investigating the crash.

Rationale: The development of effective roadway design and operation, education, and enforcement measures to accommodate pedestrians and cyclists and prevent crashes with motor vehicles is enhanced by the collection of the actions and circumstances at the time of the crash.

No Improper Action: (Non Motorist) There was no improper action on the part of the non-motorist.

Dart/Dash: (Pedestrian) Any non-motorist entering from off the roadway including running, jogging, or stumbling, etc.

Failure to Yield Right-of-Way: (Non Motorist) This is a right of way violation **not** failing to obey a traffic control device.

Failure to Obey Traffic Signs, Signals, or Officer: (Non Motorist) The non-motorist does not comply with traffic signs, signals, or Officer.

In Roadway Improperly (standing, lying, Working, Playing): (Non Motorist) This can include a bicyclist that is in the roadway or fails to keep to the right or use bike path.

Disabled Vehicle Related (Working on, Pushing, Leaving/Approaching): (Pedestrian) includes changing tire, boosting vehicle. Pedestrian must be struck first.

Entering/Exiting Parked/Standing Vehicle: (Pedestrian)

Inattentive (Talking, Eating, Etc.): (Non motorist)

Not Visible (Dark Clothing, No Lighting, Etc.): (Non-Motorist)

Improper Passing: (Bicyclist)

Wrong-Way Riding or Walking: (Non Motorist) A non-motorist walking or riding in a direction other than required by statute.

Other: Examples would include; being pushed into a roadway, falling from a bicycle, traveling on a prohibited trafficway. If used, should be explained in the narrative. **Only select “Other” if none of the other listed “Action at Time of Crash” descriptions are appropriate.**

Unknown: Only select “Unknown” when the “Action at the time of the Crash” is unknown.

67 Pedestrian Maneuvers

The image shows three screenshots of a software interface for selecting pedestrian maneuvers. Each screenshot has a 'Clear Selection' button at the top. The first screenshot shows a list of 9 options, with '7 Standing in road' highlighted. The second screenshot shows a list of 9 options (10-18), with '15 Following Trail' highlighted. The third screenshot shows a list of 5 options (15-19), with '18 Walking to/from School' highlighted.

Definition: The actions/circumstances of the non-motorist (pedestrian) that may have contributed to the crash. This data element is based on the judgment of the law enforcement officer investigating the crash.

Rationale: The development of effective roadway design and operation, education, and enforcement measures to accommodate pedestrians and cyclists and prevent crashes with motor vehicles is enhanced by the collection of the actions and circumstances at the time of the crash.

Crossing with Signal: Crossing the road with a pedestrian signal indicating “walk” or “cross”.

Crossing against Signal: Crossing the road when a pedestrian signal indicates “don’t walk” or “Don’t cross”.

Crossing Marked Crosswalk No Signal: Crossing the road in a marked crosswalk not controlled by a signal.

Crossing No Signal or Crosswalk: Crossing the road in an area without a crosswalk or signal.

Walking in road with traffic: Walking in or along the roadway in the same direction as the vehicle traffic.

Walking in road against traffic: Walking in or along the roadway in the opposite direction of the vehicle traffic.

Standing in road: Stationary in the roadway.

Emerging from behind parked car: Entering the roadway from in front of or behind a parked vehicle. The vehicle could be parked legally or illegally.

Child getting on/off School Bus: A person who is entering or exiting a school bus.

Getting on/off Vehicle: A person who is entering or exiting the passenger compartment of a vehicle or getting on or off the exterior of a vehicle.

Pushing or working on vehicle: A person who is pushing a disabled vehicle along the roadway or performing service task on a stationary vehicle.

Example: Changing a tire or boosting a stalled vehicle

Working in road: A person who is in the performance of his work duties at the time of the crash.

Examples: Emergency workers at an incident

Utility workers

Road maintenance workers

Workers performing specialized functions such as survey crews, private crash reconstruction teams.

Playing in road: Pedestrians (typically children) engaged in recreational activities.

Not in road: Persons who are not in the roadway including the shoulders.

Following Trail: A person who is walking or jogging in an area physically separated from motorized vehicular traffic by an open space or barrier and either within the highway right-of-way or an independent right-of-way.

Walking on Sidewalk: A person walking on a paved, cement or aggregate stone walkway designated for pedestrian traffic

Walking Adjacent to Roadway: A person walking along a gravel or paved shoulder or designated emergency lane.

Walking to/from School: A school age pedestrian walking to or from school.

Note: The attributes "Going to or from School" and "Working in Trafficway " take precedence when more than one attribute is applicable.

Other Pedestrian Action: Only select "Other" if none of the other listed "Pedestrian Maneuvers" descriptions are appropriate.

Definition: Any collision between a motor vehicle and a bicycle provided the bicycle is being ridden at the time of the collision.

Bicyclist: Any persons (operator and passengers) operating a unicycle, two-wheel, or three-wheel non-motorized cycle.

68 Bicyclists Maneuvers

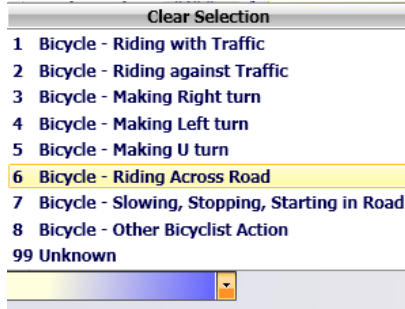

A screenshot of a software interface showing a dropdown menu titled "Clear Selection". The menu lists nine options for bicyclist maneuvers:

- 1 Bicycle - Riding with Traffic
- 2 Bicycle - Riding against Traffic
- 3 Bicycle - Making Right turn
- 4 Bicycle - Making Left turn
- 5 Bicycle - Making U turn
- 6 Bicycle - Riding Across Road
- 7 Bicycle - Slowing, Stopping, Starting in Road
- 8 Bicycle - Other Bicyclist Action
- 99 Unknown

The option "6 Bicycle - Riding Across Road" is highlighted in yellow. Below the list is a small dropdown arrow icon.

Select the actions of the bicyclist immediately prior to the crash.

Witness Elements

Select Person

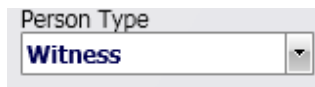

A screenshot of a software interface showing a dropdown menu labeled "Person Type". The menu is currently set to "Witness".

Definition: A witness is someone who observes the crash and reports what happened or provides information relating to the crash.

69 Name

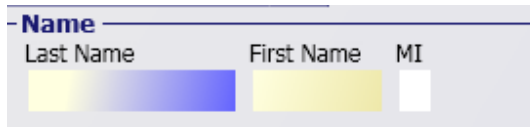

A screenshot of a software interface showing a form titled "Name". The form has three input fields: "Last Name", "First Name", and "MI".

The witnesses name should be listed as Last Name, First Name, MI

Address

The address field should be entered as the *Physical* Address, City, State (which is a drop down field) and Zip Code. The "State" field is a drop down menu and you may utilize the "type ahead" feature by selecting the first one or two letters of the two-letter state abbreviation.

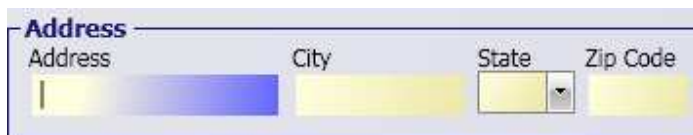

A screenshot of a software interface showing a form titled "Address". The form has four input fields: "Address", "City", "State", and "Zip Code".

Commercial Vehicle

Selection Criteria for Reportable Crashes to FMCSA

Crashes involving commercial motor vehicles and some non-commercial motor vehicles should be reported on a State's crash report and to the FMCSA. A commercial motor vehicle is any motor vehicle used on a trafficway for the transportation of goods, property or people in interstate or intrastate commerce.

Weight Requirements:

Report a crash to FMCSA via SAFETYNET if it involves:

1. Any truck having a gross vehicle weight rating (GVWR) of more than 10,000 pounds or a gross combination weight rating (GCWR) over 10,000 pounds used on public highways.



GVWR 25,960 lbs



GCWR > 26,000 lbs



GVWR < 10,000 lbs



GVWR 80,000 lbs

2. Passenger Capacity: Any motor vehicle designed to transport nine or more people, including the driver.



Or

3. Hazardous Materials:

ANY vehicle displaying a hazardous materials placard, regardless of weight.

NOTE: If a vehicle is discovered to be transporting hazardous materials without a required placard by an officer knowledgeable in Federal Hazardous Materials Regulations, it should also be reported to FMCSA.

Or

4. Crash Severity: The qualifying vehicle is involved in a crash while operating on a roadway customarily open to the public, which results in:

- a. A fatality: any person(s) killed in or outside of any vehicle (truck, bus, car, etc.) involved in the crash or who dies within 30 days of the crash as a result of an injury sustained in the crash;
- b. An injury: any person(s) injured as a result of the crash who immediately receives medical treatment **AWAY** from the crash scene; OR
- c. A tow-away: any motor vehicle (truck, bus, car, etc.) **disabled as a result of the crash** and transported away from the scene by a tow truck or other vehicle.

Examples of Included Vehicles:

1. A trucking company or individual owner/operator hauling a business' goods for a fee. (For-Hire Carrier)



2. A manufacturing company hauling its own products to retail stores, and retail stores delivering products to its buyers. (Not- For-Hire Carrier)



3. A farm hauling its produce to market.



4. A motor coach, airport shuttle or hotel-owned shuttle bus or limousine service transporting passengers.



5. Government-owned trucks and buses.



6. School buses transporting students to/from school or school-related activities.



7. Rented or leased trucks used to transport either commercial or personal goods.



8. A truck greater than 10,000 lbs. that is owned and operated primarily for commerce that is being used for personal transportation or transportation of personal goods.



Exceptions:

1. A personally-owned truck or passenger vehicle meant for personal use, even if greater than 10,000 lbs.

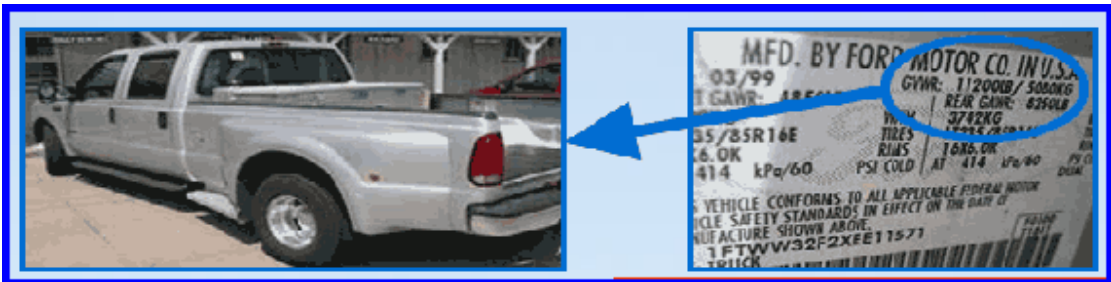

2. A driver with a disease condition (stroke, heart attack, diabetic coma or epileptic seizure) and no other injury or damage occurs, or
3. Deliberate intent (suicide, self-inflicted injury, homicide, etc.), with no unintentional injury or damage.

Non-Commercial Exceptions:

1. A non-commercial, horse rancher transporting hay bales from his or her pasture on one side of the road to his or her stables on the other side in a truck greater than 10,000 lbs.



2. A homeowner carrying recyclables to a drop-off point in a personally-owned pickup truck greater than 10,000 lbs.



3. A large family of 10 persons taking a trip in the family's 12-person van.



4. A personally-owned pick-up truck hauling a boat, camper, or horse trailer, with a GCWR in excess of 10,000 pounds.



5. A family operating a recreational vehicle/motor home in excess of 10,000 pounds.



Carrier Identification Numbers

Definition: The identification number, name and address of an individual, partnership or corporation responsible for the transportation of persons or property as indicated on the shipping manifest.

Motor Carrier- The legal business entity, individual, partnership, corporation, or organization that directs, controls, and is **responsible** for the transportation of goods, property or people.

Rationale: (Required by the Federal Motor Carrier Safety Administration CFR 350.201.) The Federal Motor Carrier Safety Administration (FMCSA) has the authority to fine and sanction unsafe interstate (and some intrastate) truck and bus companies. A key way to identify potentially unsafe motor carriers is to collect crash data by the identification number, name, and address of the company. The street address allows FMCSA to visit carriers to conduct reviews of compliance with Federal Motor Carrier Safety Regulations and provides a crosscheck for the correct identity of the carrier. The identification number (found on the power unit, and assigned by the U.S. DOT or by a State) is a key element for carrier identification in the FMCSA databases for crashes and other carrier information. This data element is collected at the scene to meet FMCSA 90 day reporting requirements.

No Carrier Identification Numbers

No Carrier Identification Numbers

Use this check box **ONLY** when no US DOT numbers, MC/MX Numbers, State Number, or MCSAP Number have been assigned.

70 US DOT Number

US DOT Number

1035558

The US DOT number is a seven digit number that is assigned to an interstate carrier.

Companies that operate commercial vehicles transporting passengers or hauling cargo in interstate commerce must be registered with the FMCSA and must have a USDOT Number. Also, commercial intrastate hazardous materials carriers who haul quantities requiring a safety permit must register for a USDOT Number. The USDOT Number serves as a unique identifier when collecting and monitoring a company's safety information acquired during audits, compliance reviews, crash investigations, and inspections.

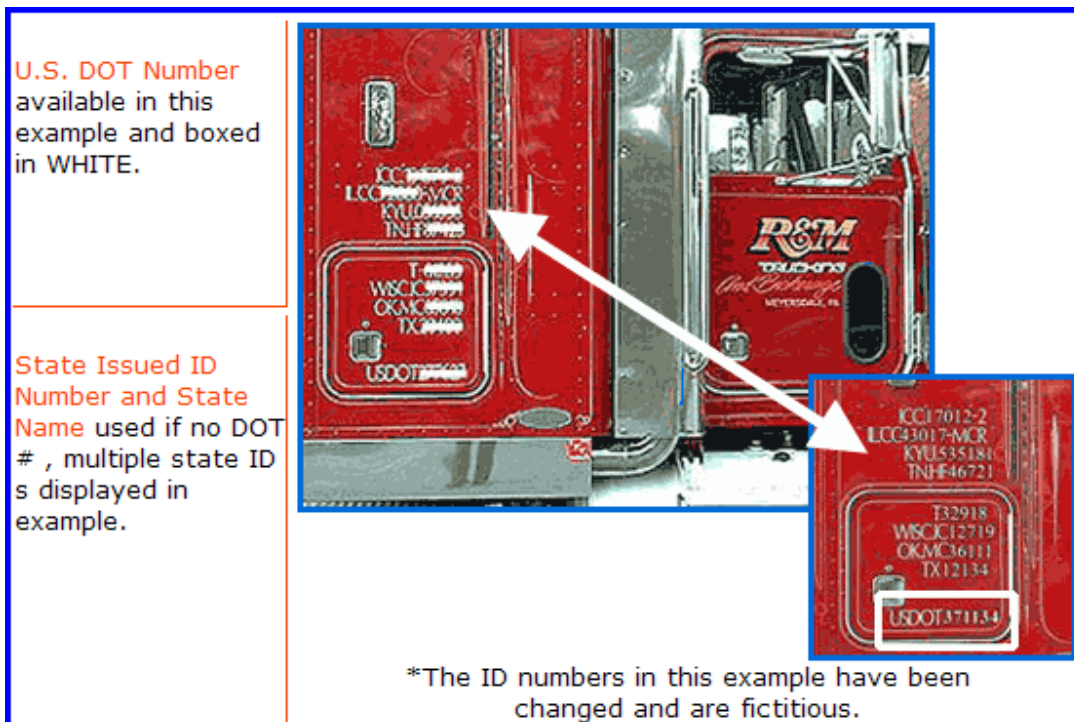

71 MC/MX Number

MC/MX Number

123456

FMCSA operating authority is also referred to as an "MC," "FF," or "MX" number, depending on the type of authority that is granted. Unlike the USDOT Number application process, a company may need to obtain multiple operating authorities to support its planned business operations. Operating Authority dictates the type of operation a company may run, the cargo it may carry, and the geographical area in which it may legally operate.

72 State Number

State Number
1234567

The state number is for intrastate companies that have not been assigned a US DOT number. They will be companies that have vehicles under 26001 lbs operating only in Maine. This number is assigned to the carrier in the SAFETYNET program. An example of the number is S00000008741. **NOTE:** The State Number will not be displayed on the truck. This field is **NOT** a required field.

73 MCSAP Number

A MCSAP report number from the Motor Carrier Compliance Report (post crash inspection report number) that is completed by either a Maine State Police CVEU trooper or a Motor Carrier Inspector. This report will have a 12 digit alpha-numeric number in the upper right hand corner. It will always, in Maine, start with ME followed by a 4 digit officer number of who completed the report, then a six digit number. (Example ME4944001234). This field is **Not** a required field but should be filled in whenever a Maine state Police CVEU trooper or Motor Carrier Inspector completes a MCSAP report as a result of a crash involving a commercial motor vehicle.

Carrier Name and Address

Enter the carrier responsible for transportation of the load involved in the crash and the home base address of the carrier.

74 Carrier Name

Carrier Name
Keystone Freight Corp

It is important that the name of the carrier **responsible** for the load is recorded as well as that carrier's DOT Number. Trip and long-term leasing can cause the names and numbers on the door to be different from the names on the shipping papers (bill of lading).

Note: For qualifying non-commercial vehicles (See Selection Criteria) such as; government-owned trucks and buses and rental vehicles, record the name of the government entity or record individual for rental trucks being used to transport personal goods as the Name of Carrier.

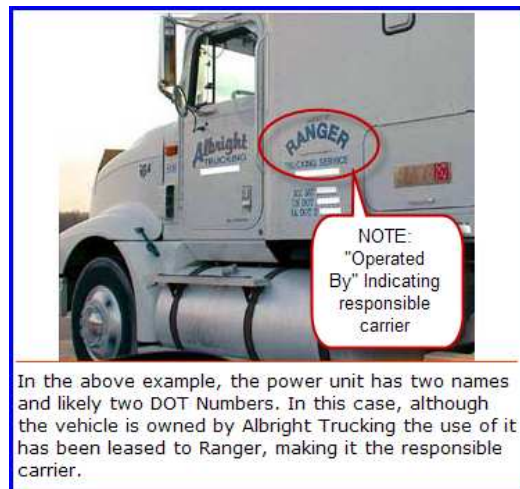



This photo illustrates a situation that may occur with vehicles which are leased. Note that this tractor semi-trailer has more than one name and US DOT number making it important to identify the proper Motor Carrier.



Blue Line has placed its name and DOT number on the vehicle and is in this instance the motor carrier that would be recorded if this vehicle were involved in a reportable crash.

Steps to Identifying Motor Carriers:

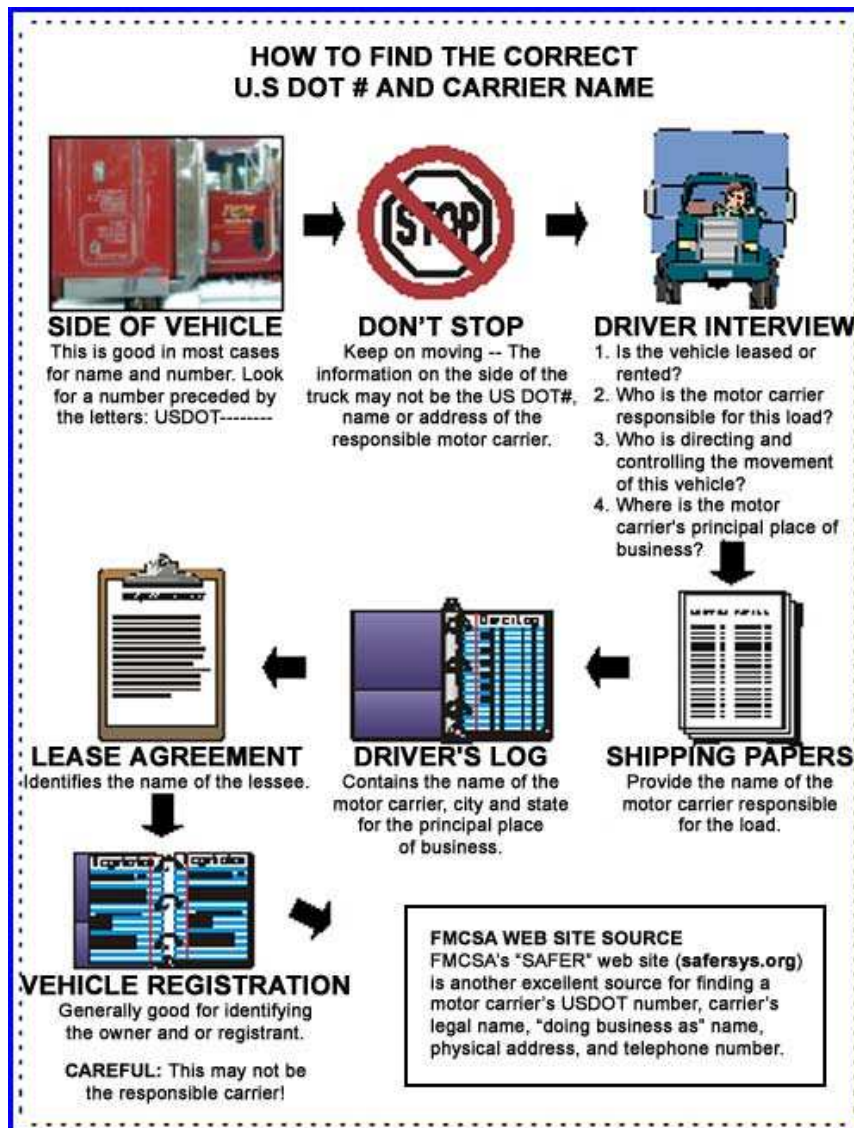

Examples: Who is the Motor Carrier?

Example 1:

John Smith owns his own truck tractor, operating under John Smith Trucking. He contracts with White Manufacturing to take one of its trailers loaded with its goods from New York to Los Angeles.

WHO IS THE MOTOR CARRIER?

<p>A. John Smith</p> <p>B. White Manuf.</p>	<p>John Smith is the motor carrier because he is the entity that has agreed to carry this particular load.</p>
---	---

Example 2:

John Smith, driving his truck tractor, utilizes a cargo broker, K&S Trucking, to obtain goods from Intermodal Inc. shipping company for his return trip back to New York.

WHO IS THE MOTOR CARRIER?

<p>A. K&S Trucking</p> <p>B. John Smith</p> <p>C. Intermodal Inc.</p>	<p>John Smith is the motor carrier because K & S transferred the responsibility of the load to John Smith.</p>
--	---

Example 3:

John Smith, driving his truck tractor, leases his services to Polyester Chemical Company. Polyester directs Smith to deliver a semi-trailer from New York to St. Louis.

WHO IS THE MOTOR CARRIER?

<p>A. John Smith</p> <p>B. Polyester</p>	<p>The lease agreement between Polyester and Mr. Smith makes Polyester the motor carrier responsible for the load.</p>
--	---

Example 4:

John Smith is driving a tractor/semi-trailer owned and operated by ABC Trucking.

WHO IS THE MOTOR CARRIER?

<p>A. John Smith</p> <p>B. ABC Trucking</p>	<p>ABC Trucking is the motor carrier. John Smith is just a driver for ABC Trucking.</p>
---	--

Example 5:

John Smith is driving a tractor owned by ABC Trucking which has been leased to XYZ Trucking. XYZ uses the tractor to pull XYZ trailers in its regular shipping service.

WHO IS THE MOTOR CARRIER?

<p>A. John Smith</p> <p>B. ABC Trucking</p> <p>C. XYZ Trucking</p>	<p>In this case, XYZ is the carrier because XYZ is directing the carrying of the load.</p>
---	---

Address

Address
2820 16Th Street

Enter the home base address of the motor carrier.

City

City
North Bergen

Enter the home base city of the motor carrier.

State

State
NJ

Use the drop down menu or the type-ahead feature to enter the two-digit state code of the motor carrier home base.

Zip Code

Zip Code
07047

Enter the five-digit zip code of the motor carrier's home base city.

Carrier Phone

Carrier Phone

Enter the 10 digit phone number of the motor carrier responsible for the load involved in the crash (###-###-####).

Vehicle Information

75

Motor Carrier Type

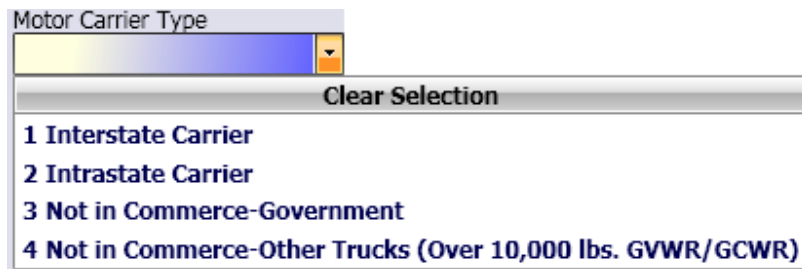

The screenshot shows a dropdown menu titled "Motor Carrier Type". The menu is open, displaying four options: "1 Interstate Carrier", "2 Intrastate Carrier", "3 Not in Commerce-Government", and "4 Not in Commerce-Other Trucks (Over 10,000 lbs. GVWR/GCWR)". A "Clear Selection" button is visible at the top of the dropdown list.

Interstate Carrier: A commercial vehicle in the United States where the transit between the points of origin and termination does not occur entirely within the borders of the state of origin. A motor carrier that has authority to operate across state lines. Interstate operators are required to have a USDOT Number by the Federal Motor Carrier Safety Administration.

Intrastate Carrier: A motor carrier that operates entirely within the state and does not have the authority to engage in interstate commerce. Intrastate operators are not required to have a USDOT Number by the Federal Motor Carrier Safety Administration however; some states do require that certain intrastate operators secure a USDOT Number.

Not in Commerce/Government: Any government vehicle whether it is operated by the local, state, or federal government. In most circumstances, the government-owned vehicle will not have a USDOT Number.

Not in Commerce/Other Truck (Over 10,000 lbs. GVWR/GCWR): A Personal rental vehicles (e.g., U-Haul, Ryder, Penske) that qualify by size (Over 10,000 lbs. GVWR/ GCWR) that are operated by a private individual. In these situations the rental company is NOT the carrier and should not be recorded.

Cargo body Type

Cargo Body Type

Clear Selection

- 1 Bus (seats for 9-15 people, including driver)
- 2 Bus (seats for 16 people or more, including driver)
- 3 Van/Enclosed Box
- 4 Cargo Tank
- 5 Flatbed
- 6 Dump
- 7 Concrete Mixer
- 8 Auto Transporter
- 9 Garbage/Refuse

Definition: The type of body for buses and trucks more than 10,000 lbs. GVWR / GCWR.

Rationale: (required by the Federal Motor Carrier Safety Administration CFR 350.201.) This data element provides additional information about the motor vehicle, including all major cargo body types. The information it provides can be important in helping FMCSA make decisions on regulatory strategies for different types of motor vehicles. This data element is collected at the scene because FMCSA requires reporting within 90 days.

Bus (seats for 9-15 people, including driver)



NOTE: The 8 PASSENGER vehicle shown in the image above is **NOT A BUS**.



The 4 Row, 15 Passenger, Extended Van (shown left) would qualify as a Bus.

Bus (seats for 16 passengers or more, including the driver)



Van/Enclosed Box: A single-unit truck, truck/trailer, or tractor/semi-trailer having an enclosed body integral to the frame of the motor vehicle.



Both Van/Enclosed Box Cargo Design

Cargo Tank: A single-unit truck, truck/trailer, or tractor semi-trailer having a cargo body designed to transport dry bulk (fly, ash, etc.), liquid bulk (gasoline, milk, etc.), gas bulk (propane, etc.).



Flat Bed: The cargo body is without sides or roof, with or without readily removable stakes which may be tied together with chains, slats, or panels.



Flat Bed (continued):



Note: These 'stake body' trucks are best recorded as flatbed cargo body types as the sides are readily removable. (See photos and definition above.)

Dump: A cargo body designed to be tilted or otherwise manipulated to discharge its load by gravity.





The photo on the left is a truck tractor with a semi-trailer that is a Dump Cargo Body Type as it can be manipulated to discharge its load.

Concrete Mixer: A single-unit truck having a body specifically designed to mix or agitate concrete.



Auto Transporter: A cargo body designed specifically to transport other motor vehicles.



The photo above right is an example of a new style of Auto Transporter. A covering or 'skin' over the cargo area is designed to protect the vehicles. It is identifiable by the unique rear loading door. This is **NOT** a Van/Enclosed Box cargo body style. Also note this Vehicle Configuration is a Truck/Trailer **NOT** a Truck Tractor/Double (Note the location of the axles).

Garbage/Refuse: A single-unit truck having a body specifically designed to collect and transport garbage or refuse. This includes both conventional rear loading and over-the-top bucket loading garbage trucks.



Grain, Chips, Gravel: Describes a cargo body type used for hauling these or other similar bulk commodities. They may be referred to as 'open hoppers' or 'belly dumps.'



Pole: A trailer designed to be attached to the towing vehicle by means of a reach or pole, or by being boomed or otherwise secured to the towing motor vehicle, ordinarily used for carrying property of a long or irregular shape.



Truck Tractor with a Pole Trailer

Logging: A cargo body type for trailers with a fixed middle beam and side support posts specifically designed for carrying logs. If the trailer can "telescope" to carry different log lengths, then it should be considered a pole trailer.



Intermodal Chassis: A cargo body type used for a trailer specifically designed to have a rail or ship container mounted directly on the chassis. These should not be confused with van/enclosed box cargo body types. Intermodal containers may also be mounted on a flatbed trailer, in which case "flatbed" is the cargo body type.



Intermodal Portable Tank

Vehicle Towing another Vehicle: Refers to vehicles that have no cargo carrying capability but are in the act of towing another motor vehicle. These are often called "drive-away, tow-aways" and will be applicable to tow trucks and specially rigged truck tractors.



Not Applicable/No Cargo Body: Bobtail, light motor vehicle w/ hazardous materials placard, etc.



Tow Truck



A tow truck without a vehicle attached should be considered No Cargo Body. However, if a vehicle is attached the correct Cargo Body is Vehicle Towing another Vehicle.



Cherry Picker



Fire Truck

Other Cargo Body Not Listed:



Example: Farm Truck

Truck Trailers with Multiple Cargo Body Types: In situations where a single-unit truck is pulling a trailer with a different cargo body type, it is suggested that the cargo body type of the power unit be used. See the photos below.



Van/Enclosed Box



Dump

77 Cargo Code

Cargo Code

▼

Clear Selection

1 Unloaded

2 Partially Loaded

3 Loaded

Unloaded: Select this option when the crash vehicle has no load affixed or attached.

Partially Loaded: Select this option when the crash vehicle is loaded at less than full capacity.

Loaded: Select this option when the crash vehicle is loaded to capacity either by weight or volume.

78 Commodity Code

CommodityCode

▼

Clear Selection

A General Freight

B Household Goods

C Metal: Sheets, Coils, Rolls

D Motor Vehicles

E DriveAway / TowAway

F Forest Products

G Building Products

H Mobile Homes

I Machinery, Large Objects

General Freight: examples would include non-hazardous items such as electronics, non-perishable food, textiles, clothing, etc.

Household Goods: Furnishings, carpeting, dishes, cookware, home décor, appliances and other household goods that are not otherwise included in any of the categories below.

Metal: Sheets, Coils, Rolls: Raw metal bulk stock

Motor Vehicles: Car carriers and other vehicle conveyances designed to carry multiple new or used vehicles that are not in tow.

DriveAway/TowAway: Flat bed or tow truck units that have or are carrying another vehicle for repair or just for basic conveyance.

Forest Products: Raw stock that would include logs, pulp or chips.

Building Products: Wood, light steel, siding, roofing, building panels, insulation and other core commercial or residential construction materials.

Mobile Homes: Homes – single or multi-section manufactured homes in transit.

Machinery, Large Objects: Manufacturing apparatus, wind turbines and blades, ship parts, engines/motors, generators, large construction and specialty equipment are examples of these large items that could be transported by flat bed or cargo trailer.

Fresh Produce: Fruits, vegetables, potatoes and other raw food products.

Liquids/Gases in Cargo Tank: Gas, oil, propane, kerosene, LPG, other fuels and compressed gases being transported in pressurized or non-pressurized tanker units.

Intermodal: Containers meant to be transferred from one transportation mode to another (from rail or ship to truck conveyance as an example).

Note: *the purpose of capturing commodity type is to track kind of goods involved in a crash event. Therefore, if goods carried can be better defined by one of the other listed commodity types, then use that commodity type.*

Passengers: Use this code if the commercial activity related to the vehicle unit is carrying multiple passengers (in a vehicle designed to carry 9 or more people including the driver).

Oil Field Equipment: Drilling equipment and other structural or mechanical equipment being used at an oil drilling location (either land or offshore drilling facility).

Livestock: Live animals in transit regardless of purpose of transit (food processing, show or general relocation).

Grain, Feed, Hay: Raw food or feed stock in transit.

Coal/Coke: Coal and its by-products like coke.

Meat: Processed meat that may be packaged for retail sales or be in transit for further processing/packaging elsewhere.

Garbage, Refuse, Trash: Non-hazardous trash. (If chemical waste, then identify this commodity as 'Chemicals').

U.S. Mail: Postal items that include both letter and parcel stock.

Chemicals: Hazardous and non-hazardous that can be in liquid or solid form (gases should be coded as Liquids / Gases in Cargo Tank).

Commodities, Dry Bulk: Examples include salt, sugar, coffee beans, and other non-grain items.

Refrigerated Foods: Perishable food items in refrigerated units.

Beverage: Beverage goods, including refrigerated, that may be conveyed in various container sizes.

Paper Products: From large finished rolled stock to packaged sheet stock. Paper, cardboard, corrugated and other pulp-based bulk or finished products are included.

Other: Only select "Other" if none of the other listed "Commodity Code" descriptions are appropriate.

79 Bus Use

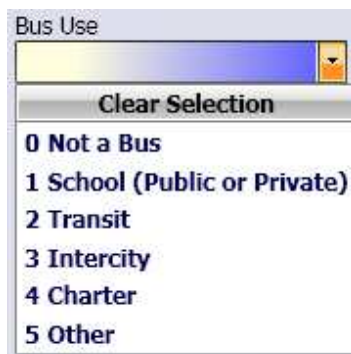

The image shows a software interface for selecting bus use. At the top is a dropdown menu with a yellow-to-blue gradient bar and a downward arrow. Below the menu is a 'Clear Selection' button. The dropdown list contains the following options:

- 0 Not a Bus
- 1 School (Public or Private)
- 2 Transit
- 3 Intercity
- 4 Charter
- 5 Other

Definition: This element describes the common type of bus service this vehicle was being used as at the time of the crash. Buses are any motor vehicle with seats to transport nine (9) or more people, including the driver's seat. This element does not include vans which are owned and operated for personal use.

Rationale: This data element provides additional information to evaluate the outcome of motor vehicles used as buses that are involved in crashes.

Not a Bus: Vehicles that do not have a bus body type AND are not being used as a bus in the crash. This should be used for vehicles with less than 9 seats (including the driver) and personal-use vans with 9 or more seats (including the driver).

School (Public or Private): Any public or private school or district, or contracted carrier operation on behalf of the entity, providing transportation for K-12 pupils.



Transit: A government entity or private company providing passenger transportation over fixed, scheduled routes, within primarily urban geographical areas. (For example; inner-city mass transit bus service.)



Intercity: A company providing for-hire, long-distance passenger transportation between cities over fixed routes with regular schedules (for example; Greyhound bus service between major cities).



Charter: A company providing transportation on a for-hire basis and demand-response basis, usually round-trip service for a tour group or outing.



Other: Other bus use would include private companies providing transportation services for their own employees, non-governmental organizations (such as churches and non-profit groups), and non-educational units of government (such as departments of corrections). (Examples include transporting people from airports, hotels, rental car companies, and business facility to facility.)



Only select "Other" if none of the other listed "bus use" descriptions are appropriate.

80

HAZMAT Class Number

HAZMAT Class Number

Clear Selection

- 1 Explosives
- 2 Gases - Compressed, Dissolved or Refrigerated
- 3 Flammable Liquids
- 4 Flammable Solids-Combustible, Water Reactive
- 5 Oxidizing Substances-Organic Peroxides
- 6 Poisonous (Toxic) and Infectious Substances
- 7 Radioactive Material
- 8 Corrosives
- 9 Miscellaneous Dangerous Goods, or Blank

Definition: Indication of whether or not the motor vehicle had a hazardous materials placard as required by Federal/State regulations, and whether or not hazardous materials were released. Any motor vehicle transporting quantities of hazardous materials in quantities above the thresholds established by the U.S. Department of Transportation, or other authorized entity is required to display a hazardous materials placard.

Note: Hazardous materials that were released from the cargo compartment should be documented whether or not the motor vehicle displayed a placard.

Rationale: (Currently required by the Federal Motor Carrier Safety Administration CFR 350.201.) FMCSA devotes special attention to motor carriers that transport hazardous materials (HM), including calculating risk assessments, determining response methods, imposing tighter regulations and conducting compliance reviews on a higher percentage of HM carriers. Getting good data on crashes involving trucks carrying HM and whether HM are spilled during the crashes helps FMCSA focus law enforcement efforts. This data element is collected at the scene because FMCSA requires reporting within 90 days.

The Hazmat Class Number is located at the bottom of the hazardous material placard and can be a one or two-digit number with a decimal in the middle. It is critical for identifying and studying various types of hazardous materials involved in traffic crashes.

Class Number should also be available on the **required** shipping papers.



Class 1: Explosives

Class 2: Gases – Compressed, Dissolved or Refrigerated.



Class 3: Flammable Liquids

Class 4: Flammable Solids-Combustible, Water Reactive



Class 5: Oxidizing Substances-
Organic Peroxides

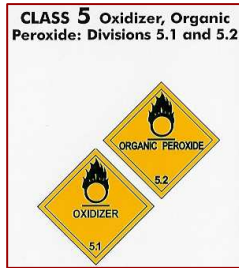

Class 6: Poisonous (Toxic) and Infectious Substances

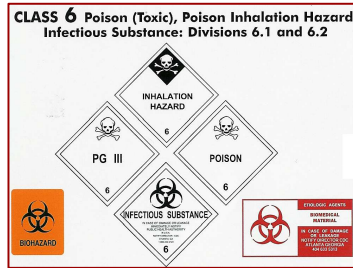

Class 7: Radioactive Material

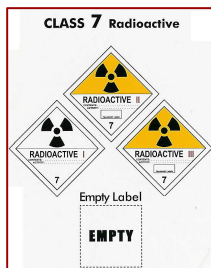

Class 8: Corrosives



Class 9: Miscellaneous Dangerous Goods, or Blank



81 HAZMAT 4 digit Number

The four-digit identification number identifies the specific hazardous material cargo.

The identification number can be found on the diamond shaped placard. On cargo tanks the Hazardous Materials ID Number may also be found on an orange panel adjacent to the placard.



If the four-digit number does not appear on the placard or on an orange panel next to the placard, both the class number and four-digit ID number should be available on the required shipping papers.

UNIFORM HAZARDOUS WASTE MANIFEST

1. Generator's US EPA ID No: V A 5 0 0 1 3 5 7 9 2 4
 2. Page 1 of 1
 3. Generator's Name and Mailing Address: Grey Grubbing Collections, Hill Bottom Road, Cramer Point, VA 61420
 4. Generator's Phone: (668) 202-2653
 5. Transporter 1 Company Name: Boomer Transport
 6. US EPA ID Number: N Y D 0 0 1 2 3 4 5 4 2
 7. Transporter 2 Company Name: [Redacted]
 8. US EPA ID Number: [Redacted]
 9. Designated Facility Name and Site Address: Duell Disposal Systems, Mean Street Extension, Toughtown, VA 21602
 10. US EPA ID Number: V A D 0 0 0 2 4 5 8 6 4
 11. US DOT Description: 9, UN2315, P III, MARINE POLLUTANT
 12. Containers: 0 0 1 T T
 13. Total Quantity: 1 8 1 8 2
 14. Unit Wt/Vol: K

4-digit ID # - 2315 (Polychlorinated Biphenyls, liquids or solids)
 1-digit Class# - 9

BULLOCKS EXPRESS
 TRANSPORTATION INC. 1-800-233-4336
 BEXT (SCAC) • P.O. BOX 16441 • Denver, CO 80216-0441

Delivery Receipt
 7-23-99
 FREIGHT BILL NO: 752-553268

EQUIP	ORIG	DEST	SHIPPER'S NO:	DATE
1	02	05	3003505	7/21/97

ORIG CARRIER (PRO. NO., DATE & DIRECTION)

C.O.D. AMT	ORIG. CARRIER	BEXT REVENUE	BEYOND

PIECES	DESCRIPTION	WEIGHT/LBS.	RATE	CHARGES
2 33	EMERGENCY CONTACT 800 228 5635 PAINT 3, UN1263, P III PAINT ALL ON 1 PLT FUEL SURCHARGE WE APPRECIATE YOUR BUSINESS !!	32 1139		

HAZARDOUS MATERIAL

NO. PIECES: 35
 DATE DELIVERED: 7-23-99
 DELIVERY DRIVER: [Signature]

CONTINUED ON NEXT BILL

4-digit ID # - 1263 (Paint, including paint, lacquer, enamel, stain, shellac solutions, varnish, etc.)
 1-digit Class# - 3

Miscellaneous Hazardous Material Information:

1. *Can a vehicle be required to have a hazardous cargo placard with only small or trace amounts?*

YES – Table 1* - Vehicles transporting any quantity of explosives (1.1, 1.2, 1.3), Poison Gas , Dangerous When Wet , Organic Peroxide, Poison Inhalation Hazard, Radioactive.

2. *Are there certain quantities for certain hazardous materials to have a placard?*

YES if over 1,000 pounds – Table 2* - Other Explosives, Flammable Gas, Non-Flammable Gas, Flammable, Combustible, Flammable Solid, Spontaneously Combustible, Oxidizer, Organic Peroxide, Poison, Keep Away From Food, Corrosive.

3. *Are vehicles with hazardous materials required to have shipping papers in the vehicle?*

YES - Since there is only room on the crash report to record one hazardous material:

- a. Record Table 1 hazardous materials over Table 2 hazardous materials.
- b. If more than one hazardous materials on Table 2, then record the information for the highest quantity of hazardous materials transported.
- c. If there is a spill, record the information for the hazardous material released.

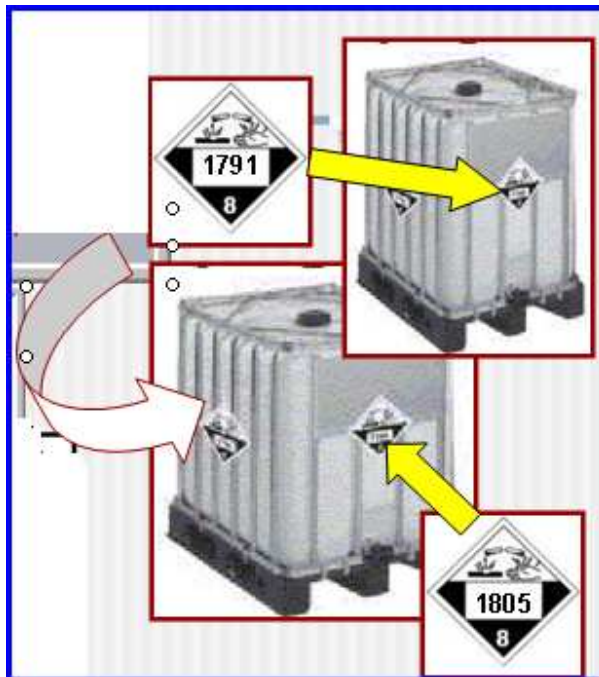

In this example, both containers hold Table #2 Corrosive materials (1791 = Hypochlorite Solution and 1805 = Phosphoric Acid). The bulk package with the Phosphoric Acid had the highest quantity, and would be recorded in the “Hazardous Material Involved” fields.

Was Hazardous Material Released

Was Hazardous Materials Released

No

Clear Selection

1 Yes

2 No

3 Unknown

Did the crash result in a release of hazardous materials from the cargo compartment:

The intent of this question is to determine whether any of the hazardous material was released.

NOTE: Fuel or oil carried by the vehicle for its own use is NOT considered cargo and should not be reported in this section.

Any material other than fuel or oil carried by the vehicle for its own use should be considered cargo.

Property Damage

Damage

Definition: Harm to property that reduces the monetary value of that property.

Damage estimates to non vehicle property should be based upon current fair market value to repair the property.

Estimates should reflect the cost to bring property back to original condition.

Only damage received as a result of the crash being investigated should be considered for repair. Pre-existing damage prior to the crash should not be considered.

Inclusions: Domestic animals that have monetary value, fencing, landscape damage, utility poles, regulatory signs, guardrails, etc

Damage Description

An accurate description of the property damage should be included in this field.

Non Vehicle Property Damage

Damage Description

Property Owner Type

Property Owner Type

Clear Selection

- 1 State
- 2 City or Town
- 3 Utilities
- 4 Private

Select from the drop down list the type of owner for the property damaged. The “type ahead” feature can be used by typing the first letter of the selection.

Property Owner

The officer should type in the owner of the property.

Examples:

State: State of Maine, guardrails, regulatory signs, warning signs, etc.

City or Town: Municipally owned, guardrails, regulatory signs, warning signs, landscaping, etc

Utilities: Poles and wires owned by Central Utility companies such as Central Maine Power.

Private: Property owned by private citizens.

Address

The address field should be entered as the *Physical* Address, City, State (which is a drop down field) and Zip Code. The “State” field is a drop down menu and you may utilize the “type ahead” feature by selecting the first one or two letters of the two-letter state abbreviation.

Address City State Zip Code

Crash Diagram

The crash scene diagram is key portion of the crash report. The diagram represents a visual interpretation of the scene, and should portray a picture of the actual events leading up to the crash through the time period when the event became stabilized. The crash report diagram should be a true and accurate depiction of the entire crash scene.

Edit Diagram

85 **New Drawing (Easy Street Draw)**

The officer should first draw the roadway pattern that corresponds to the location where the crash occurred. This will include any intersecting roads, streets, driveways, or shopping center entrances, places of business, etc.

Include also the identity of the corresponding street names or route numbers.

Indicate North by inserting a north arrow, preferably in the upper right hand corner of the diagram. (North to be indicated as related to the crash scene on all diagrams).



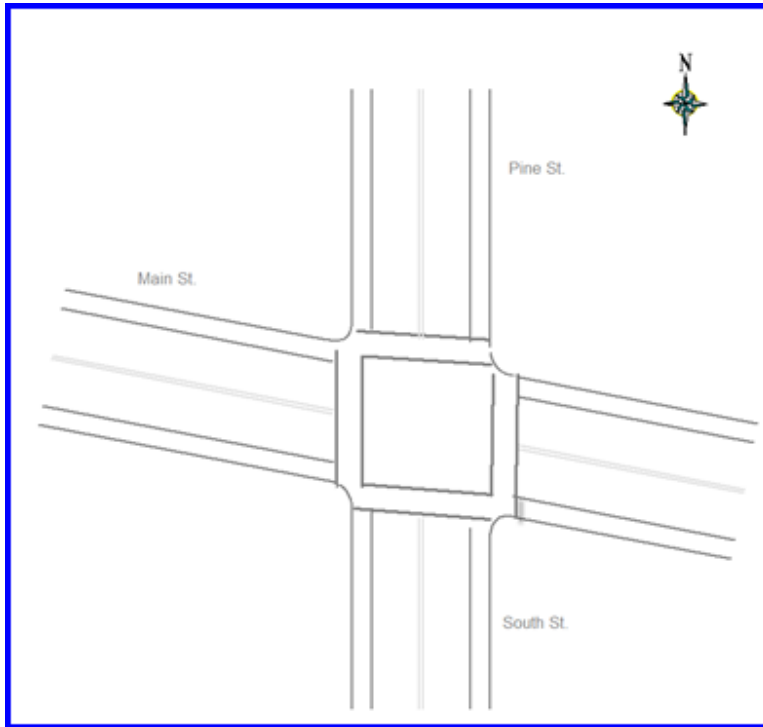

Show paths of approach and position of final rest for all vehicles. The paths of approach may be shown by inserting a vehicle prior to the impact area or by drawing an arrow showing the direction the vehicle was traveling. The area of impact may be shown either by drawing the vehicles at their place of impact, or by labeling it.

Be sure to label each vehicle accordingly.

Place on the diagram, in their proper locations, all measured data relevant to the Crash such as skid marks, utility poles, view obstructions, roadway defects, traffic control signs, automatic signals, objects on the road, etc., giving identity by name to any objects involved or attributing to the Crash. Make sure that everything on the diagram is labeled.

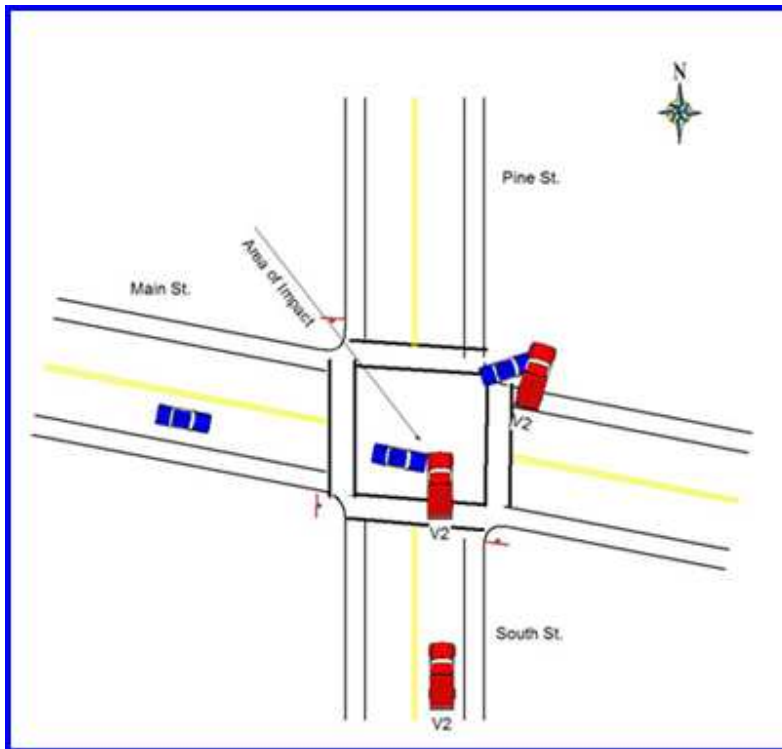

If the crash occurs in a township or smaller town, you may add directional arrows to your diagram to assist in locating the scene. For example: if your crash occurred on Route 100 in Vassalboro, you may add arrows pointing to both Augusta and Waterville for reference.



Diagram Measurements

For crashes involving a Fatality, Serious Injury, or Extensive Property Damage, scene measurements are required. Accurate and thorough measurements by the investigating officer are critical, as most often, these types of crashes result in prosecution or civil litigation. Accurate and detailed measurements are essential in order for a crash reconstruction to be completed if a reconstruction specialist was not called to the scene.

Scene Measurements

What to Measure

Items to measure include:

1. Vehicles at Final Rest (This is the uncontrolled final rest as a result of the crash)
2. Vehicles are measured either at the center of the wheels or the bumper corners
When measuring a vehicle, a minimum of two measurements are required, and they must be taken from the same side of the vehicle. (For example, the left front tire and the left rear tire)
3. Location of Area of Impact (This may be gouge, tire scuff, fluid, debris etc.).
4. Deceased Persons:
5. Decedents inside vehicles do not have to be measured.
6. Decedents (non-motorists and motorists) located outside of a vehicle are measured at the head and crotch.
7. Width of Roadway (Travel lanes, shoulders, etc.).
8. Reference Points (RP) Fixed objects in or around the scene can include: Utility Poles, Storm Drains, Bridge Abutments, Culverts etc.
Trees, Large Rocks and Guard Rails should not be used as reference points!
9. Crash Evidence (Tire marks, debris, gouges, etc.)
10. Location where vehicle left the road, rolled over etc.

Diagramming Method

The preferred method for taking measurements is the Baseline/Offset (Coordinate, X/Y) method.

This method of recording measurements involves the use of a straight “baseline”, from which all measurements are made.

Two measurements are used to locate each item of evidence and all measurements are relative to the baseline.

Baseline Offset measurements allow more information to be placed on a single diagram and are beneficial on crash scenes involving many items to be located.

These measurements can be inserted directly into the MCRS crash report.

This measurement system is based on the four-quadrant system, with the X-axis being the baseline

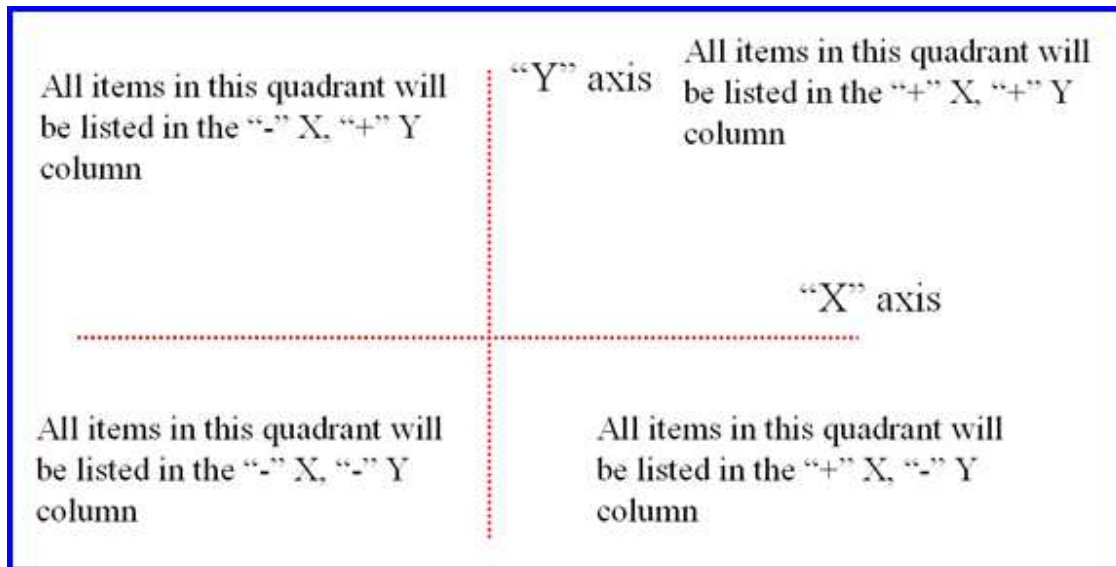

The point where the X and Y axis intersect (baseline begins) is known as “Zero Point ” or the “Origin”, as it has no X or Y value

Measurements taken from “Zero Point” or the “Origin” are taken from the baseline, and are recorded in the +X (East) or –X (West) column.

Measurements taken from the object to the baseline will be listed in the +Y (North) or –Y (South) column

Measurements					
Label	+X	-X	+Y	-Y	Description
<input type="text"/>					
<input type="text"/>					

Measurements along the baseline to the right of the “zero point” will be placed in the +X (East) Column

Measurements along the baseline to the left of the “zero point” will be placed in the -X (West) Column

Measurements from evidence above the baseline will be placed in the +Y (North) Column

Measurements from evidence below the baseline will be placed in the -Y (South) Column

It is important that all measurements are taken perpendicular (90 degrees) with the baseline!

Alphabetical identifiers will be placed along the baseline, in line with each piece of evidence.

In most cases, it is beneficial and easiest to place the “zero” end of the baseline tape measure to the left of all the scene measurements.

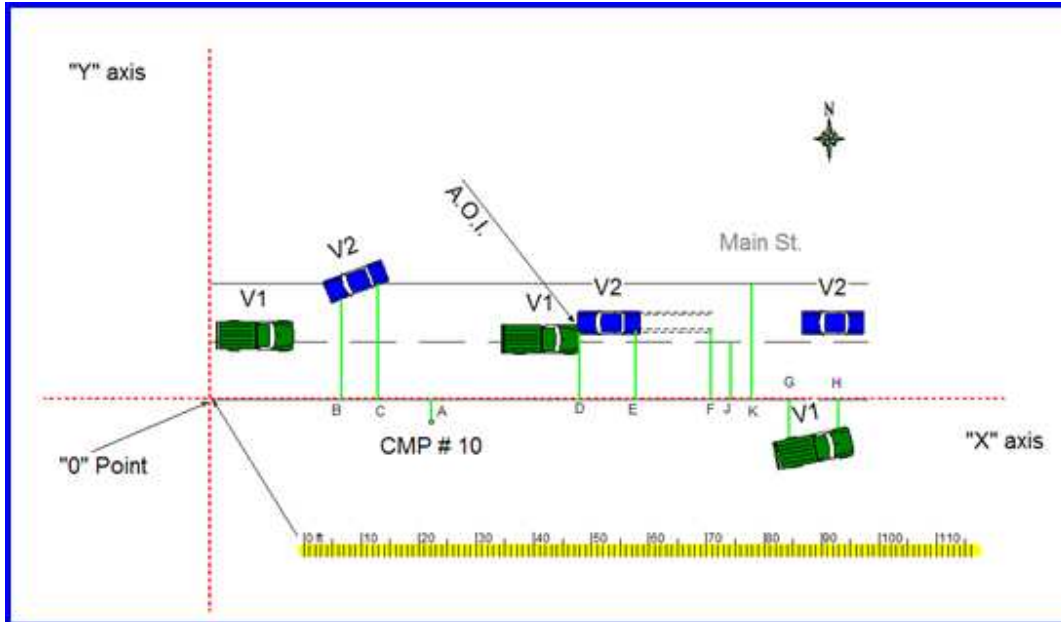

NOTE: Do Not Draw “X” and “Y” Axis lines (red) or lines to evidence (green) as shown above. They are for reference only!

The measurements are then recorded in the legend.

X, Y Recording System					
Label	+X	-X	+Y	-Y	Description
A	50			10	RP1 CMP #10
B	30		22.5		LF V2 at Final Rest
C	39		25		LR V2 at Final Rest
D	95		14		Area of Impact
E	106		13		End of V2 Skid
F	134.4		12.6		Start of V2 Skid
G	153.5			16.6	LR V1 at Final Rest
H	166			15.4	LF V1 at Final Rest
J	140		12		East Bound Travel Lane
K	141		24		Road Width

Important: the baseline always runs left to right (East/West), therefore, when drawing the scene diagram in MCRS, make sure the scene is rotated so the baseline is oriented in the proper direction.

Special Instructions

NOTE: in order for the measurements to be accurate, the baseline (tape measure) must be straight and be at a 90 degree angle to the reference point.

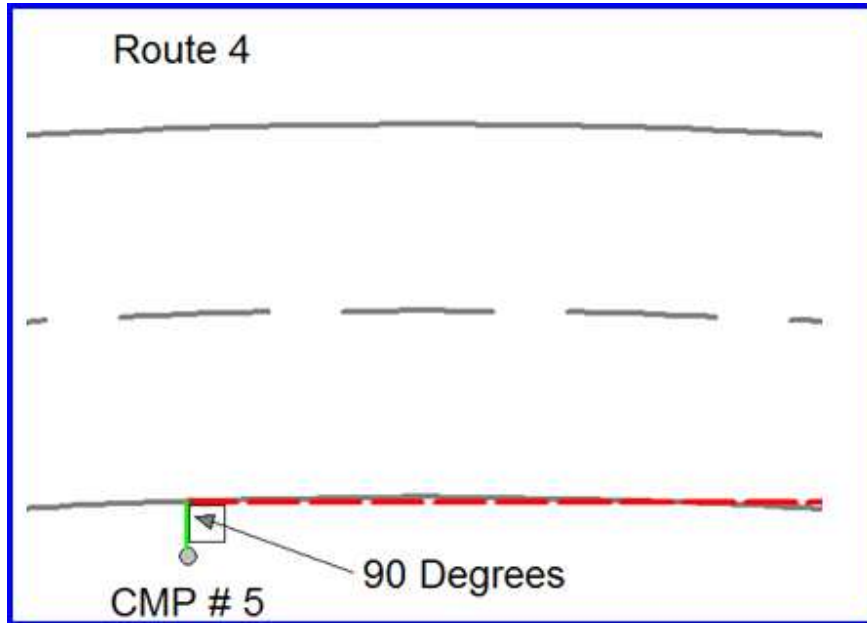

To ensure you are at 90 degrees, you can use anything with a straight edge, like a notebook pad



The baseline Does Not necessarily follow the road edge!

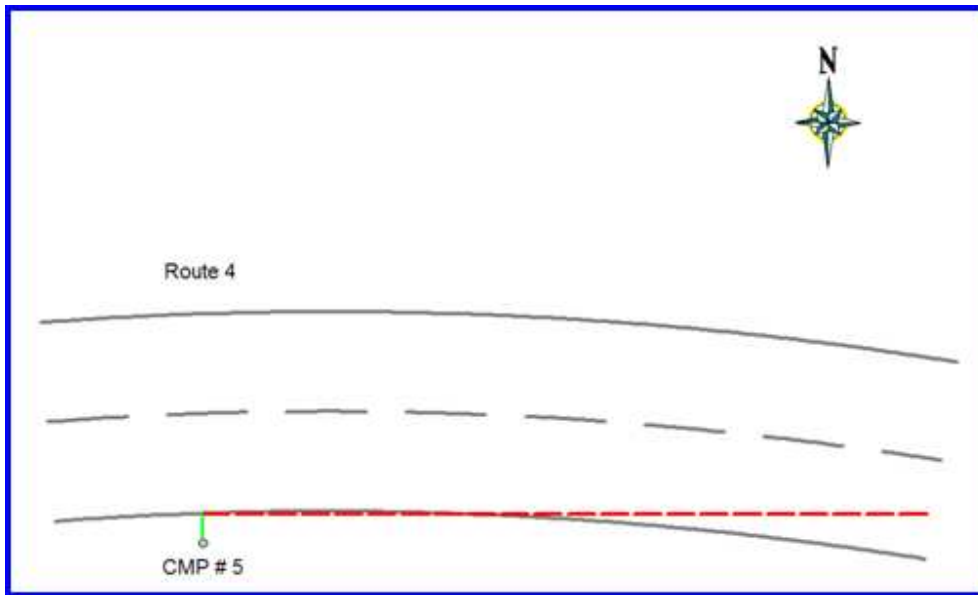

If the baseline does not follow the roadway, try to reference it to a second fixed object.

If there is not a second fixed object near your scene, it may be referenced to the edge of the roadway.

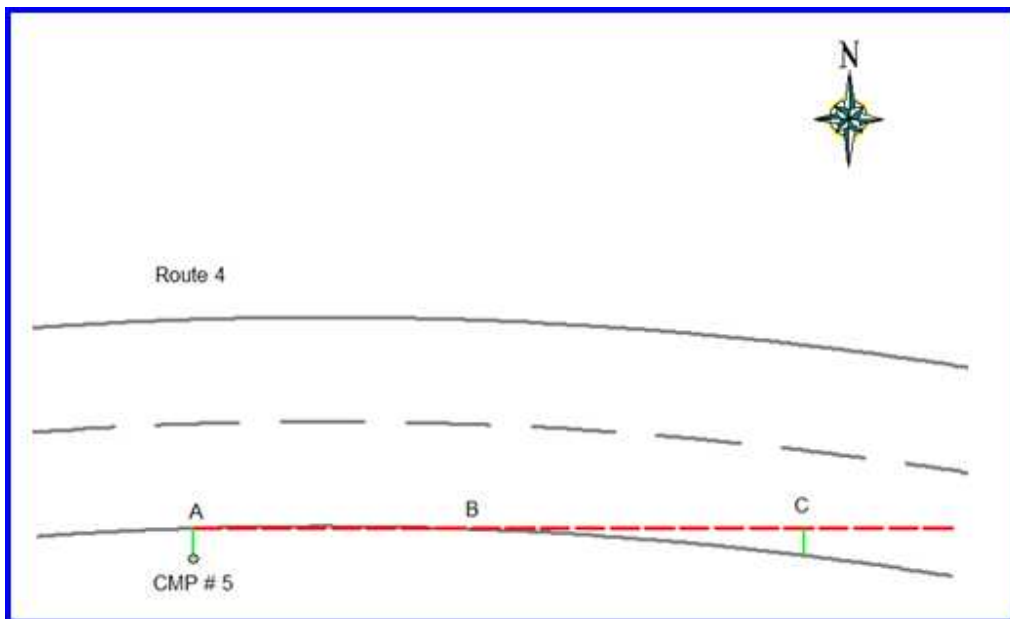

If you don't have a fixed object near your scene to use as a reference point, you may use a curb extension. (Extending two tapes from a curb until they intersect.) The point where the tapes intersect can be marked and used as a reference point.

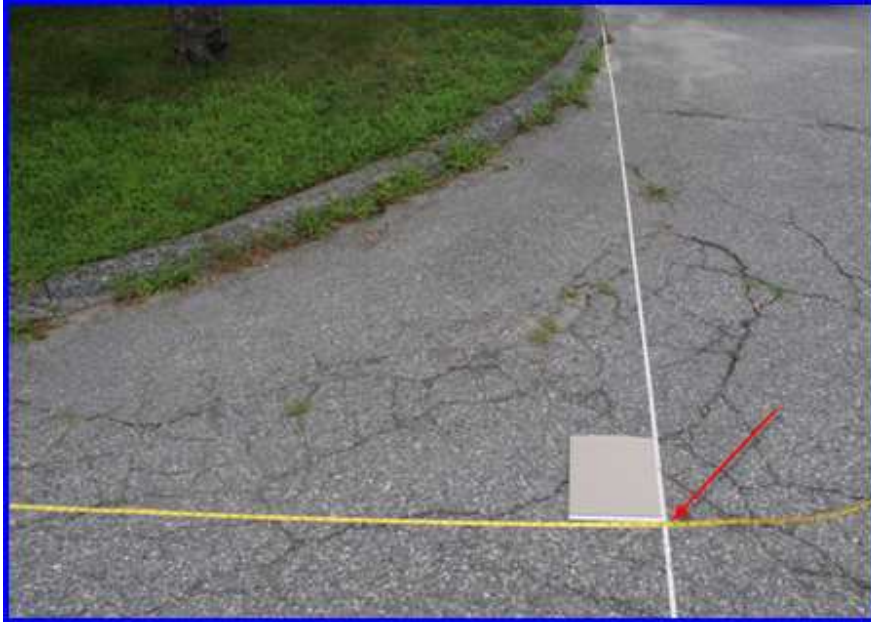

When using two tape measures, ensure that both use the same unit of measure (feet/inches, feet/tenths).

Fatal Crash Investigation

A motor vehicle traffic fatality is any death that is a direct result of injuries received from a motor vehicle traffic accident. The death is assigned to the accident provided that the death takes place within thirty (30) days of the date and time of the accident. (The cause of death is to be assigned by the Medical Examiner in the death certificate).

Whenever a crash involves serious personal injury with potential fatal injuries resulting, the crash should be investigated the same as a fatal crash.

Who can investigate a serious personal injury or fatal crash?

A fatal crash must be investigated by an officer who has met the training standards of a full-time Law Enforcement Officer.

Equipment

Some equipment and supplies are essential for obtaining and especially recording traffic crash information. However, excellent data collection is possible with a well-trained investigator who has only a pencil and paper for notes. Elaborate equipment such as a forensic mapping total station is no substitute for investigator competence.

Emergency Equipment

The need for such items as warning devices and first aid supplies for emergencies depends on facilities of associated agencies such as fire departments, rescue squads, and towing agencies in your area.

Forms

Forms including the MCRS crash report are basic pieces of equipment necessary for complete data collection at a crash scene. Properly structured forms can guide routine data collection. This is very helpful for experienced and inexperienced investigators.

A *clipboard* or other writing surface is usually provided for making notes in the field. It is recommended that all filed notes are retained for potential litigation.

Interviewing requires only a pencil and paper for notes. However, tape recorders or digital recorders are recommended.

Measuring

Minimum equipment for measurements is two 100 foot long tape measures. Both tape measures should be incremented in the same units such as feet and tenths of feet and inches.

Additional equipment for measurements may include:

A tape rule, preferably 25 feet long

A measuring wheel

Surveyor pins or “PK” nails

Anchor weights, for holding the end of a tape when you have no helper.

Material for marking spots to be located: Lumber crayon or aerosol spray paint.

Nails and cards for marking off-road locations.

A line level and chalk line for measuring grades and horizontal and vertical distances of falls.

Forensic Mapping total station and data collector.

Photography

Photography has long been an important adjunct to crash investigation. Photos are an indisputable, permanent record of observations.

Cameras, even the simplest can take important pictures. Over recent years the rapid increase in digital technology with regard to resolution has resulted in most agencies phasing out film-based photography. It is possible to obtain very inexpensive digital cameras for quick scene shots with relatively good quality. A useful document in the use of digital photography by police agencies is entitled “Recommendations and Guidelines for use in Digital Image Processing in the Criminal Justice System.” And is available online at the International Association for Identification Web site, www.theiai.org.

Flash Equipment is essential for night photos.

Planning At-Scene Investigation

Principles and Problems

Why planning is needed. Often an investigator wishes that he could go back and investigate a crash all over again. He or she may have neglected to look into an important matter or forgotten a vital activity. These and other mistakes result from lack of planning.

Planning is laying out a course of action or method of accomplishing objectives. Activities necessary to accomplish the objectives are the various techniques of crash investigation. Consequently, in planning, decisions are made about what *must* be done, what *should* be done, and what *might* be done. These decisions establish priorities for activities. Planning also determines the sequence of activities. The most important activity is not always the most urgent. Planning a particular at-scene investigation is always difficult because it must be done on extremely short notice, and usually with very limited knowledge of the situation. Also, planning at-scene investigations must be continually adapted to circumstances as the investigation proceeds. Throughout the investigation, tactics planned must be guided by the objectives of investigation and associated tasks (for example, emergency activities).

Five times during investigation at the scene, the situation can be evaluated well enough to plan what to do next. These stages of planning are:

On learning of the collision

On arrival at the scene

When the emergency is under control

When the urgent data collection is complete

When the work at the scene is complete

For each of these five stages of planning the following exhibit lists activities to be considered. Activities are more or less in the order in which they might be performed.

1. ON LEARNING OF THE COLLISION	
<p><u>Ask first.</u> Exactly when and where did the collision happen? How bad was the collision and what vehicles were involved? Did you see the collision happen and where can you be found? <u>Decide whether to go to the scene.</u> Will the scene have been cleaned by the time of arrival? Is it in the investigator's area? Should headquarters be informed or consulted? <u>Then find out, if necessary.</u> Is traffic blocked? Has ambulance, wrecker, or fire apparatus been called? <u>Arrange for any needed help.</u></p>	<p><u>Start for the scene.</u> With radio, the two previous things can be done while on the way. <u>Choose best approach.</u> Consider time, possible traffic jams, possible route of drivers involved, and probable situation at the scene. <u>Be alert for vehicles leaving the scene</u> as possibly carrying witnesses or hit and run drivers. Record registration numbers of any likely looking vehicles. <u>Look for conditions</u> confronting a driver approaching scene: low visibility, view obstructions, and traffic controls. <u>Note hazards</u> to approaching traffic. Place fuseses, etc.</p>
2. ON ARRIVAL AT THE SCENE OF THE COLLISION	
<p><u>Select a parking place</u> carefully. Is it safe? Will it block traffic? Can headlights illuminate scene? <u>Look over bystanders and others</u> for drivers, possible witnesses and volunteer helpers. <u>Look for fire and electrical hazards.</u> Get them under control. Have spilled hazardous materials guarded. <u>Look for hazards.</u> Put out fires. Ask helper to direct traffic. Keep bystanders out of roadway. <u>Look for physical evidence.</u> Have it guarded until it can be examined, collected, or located by measurements.</p>	<p><u>Look for congestion.</u> Direct traffic or have it directed. <u>Care for injured.</u> Stop arterial bleeding and treat for shock. <u>Ask for emergency assistance</u> from bystanders or others. <u>Locate drivers.</u> Consider possibility of hit and run and need to alert head quarters. <u>Look for witnesses still at scene.</u> Arrange to question and get names and addresses. Note registration plates on vehicles as leads to witnesses. <u>Arrange for clearing roadway.</u> Delay removal of vehicles, except to aid injured, until positions are marked.</p>
3. WHEN THE EMERGENCY IS UNDER CONTROL	
<p><u>Preliminary questions of drivers:</u> Who was driving each vehicle and what were travel plans? Note unpremeditated statements. Look for signs of nervousness, confusion, intoxication. <u>Gather evidence clues</u> for hit and run cases. <u>Question other witnesses,</u> especially bystanders who may be anxious to leave. If important, get signed statements at once from any person who may be difficult to find later. <u>Examine driver condition.</u> Look for signs of intoxication and drugs; question about drinking, get specimen for chemical test. Question about trip plan for possible fatigue.</p>	<p><u>Question drivers more fully:</u> Check license and registration; record data from them; verify address and identity. Get step-by-step account of what driver saw and did. <u>Observe vehicle condition.</u> Note lights, light switches, gear position, and tires. <u>Photograph</u> tire marks and location of vehicles. <u>Measure</u> to locate marks on road and vehicle final positions. <u>Record</u> place to which injured persons and damaged vehicles were or are to be taken. <u>Have road cleared</u> if traffic is obstructed.</p>
4. WHEN URGENT DATA-COLLECTION IS COMPLETE	
<p><u>Decide whether proof of violation is sufficient</u> for enforcement action. If so take enforcement action. <u>Tell drivers</u> what reports they must make and dismiss them. <u>Have involved parties exchange</u> names and insurance data. <u>Determine exact location of collision</u> and record it. <u>Make test skids,</u> if needed and not possible later. <u>Complete examination of vehicles.</u></p>	<p><u>Make additional photographs:</u> View obstructions, vehicle damage, pavement condition, control devices, general views. <u>Get additional statements</u> from witnesses remaining at scene. <u>Measure for map</u> if location will be difficult to revisit. <u>Clean up location</u> or arrange to have it done. <u>Report to headquarters.</u></p>
5. WHEN WORK AT THE SCENE IS FINISHED	
<p><u>Notify relatives</u> of dead or injured and owner of vehicle. <u>Inform</u> other agencies of conditions needing attention. <u>Identify</u> all notes with place and file.</p>	<p><u>Complete factual data</u> on report if not completed at scene. <u>Complete report.</u> Submit for approval and file. <u>Present case summary</u> to prosecutor.</p>

Planning begins on first learning of the crash and continues until at-scene activities are completed. Information on which initial planning is based comes at the time you learn that you will have responsibilities at the scene. At this time, obtain as much data as you can about the crash. Other information includes:

Location of the crash

Time of occurrence

What is involved

Extent of injury and damage

Obstruction of traffic

Whether fire is involved

Have ambulance, tow truck, fire equipment, and other investigators been called

What assistance or other resources may be available

On the basis of this information, plan your route to the scene and consider possible things to be done at arrival. As you approach the scene, begin investigation by watching for vehicles that may have passed the scene. Noting their registration numbers may lead to discovery of a witness who otherwise would have been unknown.

Considerations in Planning

Flexibility is necessary. Trying to follow a fixed step-by-step procedure in investigating at the scene can be as bad as having no plan at all. Plan as far ahead as possible with the information available at the moment. Then adjust and extend the plan as more information becomes available. While each thing is being done, give it careful attention, but at the same time consider the next step.

Urgency is the basis of timing. Decisions based on urgency are intended to accomplish first those things which will be most troublesome if put off. In every crash, for example, the first thing to do on arrival at the scene is to keep the crash from getting worse by preventing fire, attending to the injured, taking measures to keep traffic from plowing into people or vehicles on the road at the scene. In other words **Secure The Scene**. Often several things can be done at the same time. When helping an injured pedestrian for instance, his or her position can and location can be noted and perhaps marked, possibly, he may be able to answer questions. Some activities can be divided and advantageously done at different times during the investigation. For example, necessary photographs of cars in their final positions may be taken soon after arrival at the scene. Then much later, after the cars have been moved, other pictures may be made of damage to the vehicles.

Severity of the crash will largely determine what must be done first. When you arrive at the scene, you may find urgent matters to be attended to that are not part of the actual investigation. Think immediately of what could cause the *worst* additional damage or injury and take care of those things first. Usually three possibilities must be considered:

Oncoming vehicles are dangerous, especially at night and at places where visibility is limited. Park your police vehicle in a safe, convenient position at the scene. Flares and reflectors may be placed at intervals along the road. If necessary, and available, additional personnel must be stationed on the road to direct traffic and warn oncoming drivers of a hazard ahead.

Injured person must be given what help is possible at the scene, and transported to hospitals if necessary.

Fire must be extinguished as quickly as possible and, if necessary, fire fighting equipment requested. Attention must be given to possible fire and explosion hazards such as spilled fuel or chemicals; the whole area may have to be secured to prevent bystanders from contributing to the hazard. The power company must be called if wires are down.

How and when to request help is essentially a communication issue. Usually it is not known whether help is necessary until the investigation is started. Any of three types of help may be needed:

Emergency Help, such as ambulance, fire equipment, and help controlling crowds or traffic

Help in investigating is needed, usually taking statements from witnesses who live far away and will be difficult to talk to later. Crash reconstruction, and forensic mapping specialists may be needed

Other police personnel to take over if your duties take you away from the scene.

Division of work. When there are two or more investigators at the scene of a crash, a logical division of effort may be accomplished by one concentrating on observations and the other on information from people. Observations would include noting marks on the road, final positions of vehicles, and damage to vehicles. This investigator would be responsible for measurements and photographs to record these observations. Information from people would involve inquiries of those involved and other witnesses as to what they had seen, where they were located, or what they know of the circumstances of the crash.

Information from People

Three components of the highway system are involved in every motor vehicle crash:

1. People
2. Vehicles
3. Roads

Four kinds of information can be gathered in crash investigation for each of these three components:

1. Identification
2. Description
3. Condition prior to crash
4. Results of the crash on the component.

In crash investigation, obtaining information from people is more complicated than obtaining data on roads and vehicles. Numerous people are involved in one way or another with virtually every crash and it is often difficult to find these people.

Informants

People connected with the collision. The extent to which a person can contribute to your knowledge about a traffic crash depends on his relation to the events of the crash or its aftermath. The terms used to classify people concerned with the collision have the following meaning:

1. *Driver.* The person who drives or is in actual physical control of the vehicle. Generally this is the operator of a motor vehicle, but it could also be a bicyclist. What will be said of drivers can also be said of pedestrians who were involved in the crash.
2. *Passenger.* Any person in or on the vehicle involved in the crash other than the driver.
3. *Witness.* Any person other than a driver or passenger who was at the scene of a crash while vehicles or people involved were still there. Such a witness may have actually seen some of the events of the crash occur, or he may only have seen some of the results. In this respect, police, rescue personnel, tow personnel, bystanders, and passers-by are witnesses.
4. *Acquaintance.* Any person other than a driver, passenger, or witness who is acquainted with people or vehicles connected with the collision or knows some of the results or other circumstances of the collision. "Acquaintance" as used here means more than the casual friend of a driver or some other person. It includes such people as physicians who treat the injured, vehicle owners, relatives of people involved, bartenders who saw drivers before the collision.

If any of these four kinds of people give information about the crash, he/she may be spoken of as an informant. In this case an informant is someone who has information about the crash. Drivers, pedestrians, and passengers may also be spoken of as *the injured* if they were hurt in the collision.

Levels of Inquiry

The extent to which investigators go in obtaining information from people about a traffic crash depends on circumstances. Ordinarily only a few facts will suffice. Sometimes, however, the fullest possible detail is needed. Thus, there are levels of inquiry that resemble the five levels of collision investigation. These levels may be designated as:

1. Identification and description only – first level of questioning and information gathering.
2. At-scene inquiry – second level of questioning and information gathering.
3. Detailed statements – third level of questioning and information gathering.
4. Testimony and depositions – fourth level in which a person is under oath, transcripts are made, questions can be asked by attorneys, and there can be cross examination.

5. Formal questioning – the fifth level of obtaining information. Its main purpose is to attempt to obtain a confession from a person guilty of a crime. This is usually conducted by prosecuting attorneys or police specialists (detectives) and never at the scene.

Place of Inquiry

Questions about a traffic crash are asked of informants at a variety of places:

1. *First at the scene.* Information obtained here is most reliable because events are fresh in the minds of persons being questioned.
2. *At a hospital.* Injured persons are sometimes transported to hospitals before there is a chance to question them.
3. *Later at the site.* Sometimes it is helpful to meet informants at the site some time after the crash when conditions for inquiry are more favorable than they were at the scene.
4. *Elsewhere.* It may be necessary to question people at other locations depending on the convenience of the investigator and informant. This may be by telephone.

In theory, you should get all the information possible about the crash at the scene.

In practice this is impossible for a number of reasons. The most obvious is that the injured are often in no condition to answer any questions. But even when questioning would be possible, circumstances prevent it. Uncomfortable weather conditions, bothersome bystanders, and the urgency of restoring normal traffic flow often take a precedent. Under these conditions, decisions have to be made in serious crashes about whom to question and what to ask.

As a rule it is better to identify as many people as possible who may have information than trying to get detailed statements from one or two.

Finding Informants at the Scene

There is a revealing first question which you can ask any person who might be an informant. “How did you first know about this crash?” The answer will probably tell you at once whether he/she has anything significant to say. It also may tell you whether he/she was involved in any way. Two additional questions (see Initial Questioning at the Scene) will usually tell whether the information a person has is worth pursuing. If the informant does seem to have useful facts, identify him at once by getting his/her name, address, and contact information.

Finding Driver at the Scene

Locating drivers is the first thing to be done after handling emergencies at the scene. In many crashes, finding the driver is not difficult. He/She may still be sitting at the wheel of the vehicle, or he and another driver may be the only persons at the scene. Sometimes the driver will walk up to you and identify himself/herself.

Driver-finding difficulties

1. Occupants are dead or too badly injured to say who was driving, and you cannot determine this from the positions of their bodies.
2. The survivor says the dead occupant was driving but you suspect otherwise.
3. Occupants decline to reveal which one of them was driving. Sometimes a passenger will falsely claim to have been driving. This might be done for several reasons. The actual driver may have been intoxicated, under age, or have a bad driving record.

Look for physical signs that might indicate who was driving, especially if there was more than one adult in the vehicle and no one was properly behind the wheel after the crash.

Look for signs of where bodies struck the interior of the vehicle so they can be matched with injuries. For example, a steering wheel often inflicts chest injuries.

Get detailed description of injuries from medical personnel, surgeons, or medical examiners.

Look for telltale signs such as imprints of brake or accelerator pedals on footwear.

Sometimes hair can be found in windshields.

Finding Witness and Passengers

Look for witness and passengers as soon as possible after getting to the scene. If only a few people are present, witness can be located by asking each person if they saw the crash.

When a crowd has gathered at the scene, locating witnesses is often difficult. Because volunteers are rare, you often have to appeal to the crowd. Start, for example by asking “Who was here first after the collision?” Later questioning will reveal whether the person actually saw the crash.

Another way to locate witnesses is to watch reactions of people in the crowd to statements made by the driver or passengers. For example, a driver may tell you he was traveling 20 mph. You repeat this in an audible voice. This may cause a person in the crowd to come forward and tell you the driver was not going 20 mph. It was more like 35 mph. Such a volunteer may be able to give other information.

Useful witnesses are not only those who actually saw the crash, but also people who arrived at the scene before you did. Such witnesses can tell you whether bodies or vehicles were moved before you arrived and may report things drivers said to them.

Description of the informant. In addition to sex, age, occupation, and relationship of the informant to the crash (driver, passenger, etc.), the relationship of the informant to people involved in the crash (friend, relative, employee, etc.) helps evaluate the reliability of the information.

Initial Questioning at the Scene

The scene of a crash is not the easiest place to ask people what happened. There is too much going on and many other conditions may be unfavorable. Yet this may be the best and possibly the only opportunity you have to get certain information.

Therefore, try to get *basic* facts from as many informants as you can as quickly as possible and identify each informant so that additional data can be obtained later, either at the scene or elsewhere.

Basic Questions

Some basic questions are listed below:

1. How did you first know about this crash?
2. Where were you at that time?
 - a. In the vehicle?
 - b. Elsewhere?
3. What were you doing?
 - a. In the vehicle
 - b. Vehicle movement on the road
 - c. As a bystander or passer by
4. What is your name?
5. Where do you live?

Persons in the involved vehicle

1. Which direction were you traveling before the crash?
2. Who was driving the vehicle you were in?
3. What was he/she (you) planning to do?
4. How did he/she (you) try to avoid the crash?
5. Show me exactly where the crash occurred.

Bystander or Passer By

1. Show me the where the vehicle (pedestrian) was when first seen by you.
2. What was he/she (it) doing at that time?

3. If you saw the actual crash, show me exactly where it occurred.
4. If you saw the actual crash, show me exactly where you were at the time of the crash.
5. Show me where the vehicle (pedestrian) came to rest.

Written Statements. Sometimes you can ask the informant to write, at the scene, what he/she knows about the crash. He/she may do this either on a blank sheet of paper or some kind of prepared form. This may be useful if you are working alone. However it rarely saves you time because you must review carefully what was written to be sure it is legible and sufficient for the purpose.

Detailed Statements. A detailed statement is taken to obtain a written record of exactly what a certain person says about the crash. This statement may include answers to specific questions during a follow-up interview. The detailed statement may include such information listed below:

1. Time and place the trip began
2. Intended destination and expected time of travel
3. Time, location, duration, and purpose of stops made before reaching the scene of the crash
4. Principal purpose of the trip, such as, home from work, shopping, or visiting friends
5. Intended movement immediately before the crash, for example, turning left, merging, overtaking, slowing to park
6. Trip vehicle, general description
7. Passengers' names and addresses (if not already known to the investigator), where seated in the vehicle, age, sex
8. What was the exact position of each vehicle when it came to rest?
9. Where was each involved person after the crash? Especially where were the injured?
10. What damage to the vehicles did you observe?
11. Were there marks on the road? Including tire marks, gouges, and liquid splatters

Condition before the Crash

After a traffic crash, determining whether unfavorable driver/pedestrian conditions contributed to the event is more difficult than determining conditions of the road or vehicle. Roads and vehicles generally remain, for some time after the crash in about the same condition so that they may be examined carefully and perhaps tested. People begin to change in important ways soon after the crash.

Distinguish between driver conditions before and after a crash. The crash often changes the condition of the driver. We are interested primarily in prior conditions as possible contributing factors. You can observe many driver conditions, particularly physical abilities or disabilities, after the crash. However, you must ordinarily use methods other than observations to determine what a driver's attitude or even physical condition was immediately before the crash.

Driver behavior is a factor in nearly every traffic crash. The driver makes the decisions and controls the vehicle. The vehicle does not perceive potential or actual hazards. The vehicle does not adjust its speed or position on the road according to existing conditions. The vehicle does not determine what evasive actions are appropriate. The vehicle does not evaluate the risk of the trip in the first place.

At the scene of a crash the investigator must rely on his or her observations of the drivers/pedestrians, information gathered from informants such as witnesses and acquaintances, and statements made by involved parties.

Driving Impairment

Five main conditions may temporarily impair the ability to drive:

1. Alcohol
2. Drugs and medications
3. Driver distractions
4. Drowsiness and sleep
5. Sudden disablement (medical condition such as seizure, blackout, sudden extreme pain)

These conditions may be identified by investigator observations, informant information, and/or follow up chemical tests.

There are many other factors in driver behavior that are beyond the scope of this manual. They include:

1. Reaction times
2. Perception and perception delays
3. Driver abilities both natural and learned
4. Visual acuity or sharpness of vision

These factors may be investigated by personnel with special training such as a crash reconstruction specialist.

Information from the Vehicles

Examining anything involved in a traffic crash requires obtaining four kinds of factual information about the person, road, or vehicle:

1. Identification
2. Description
3. Condition prior to the crash
4. Effects of the crash.

Identification

There are several ways to identify a motor vehicle, that is, to distinguish from all other vehicles. :

1. Registration number
2. Owner's name and address
3. Vehicle Identification Number (VIN)
4. Manufacturer
5. Make
6. Model year

Description

Description of the vehicle as it was immediately before the crash serves two main purposes: 1) classification for statistical tabulations; and 2) description of the vehicle and its load, especially descriptions of conditions that may have contributed to the crash.

Descriptions of vehicles generally include:

1. Body style and appearance
2. Size and general structure
3. Use or service
4. Vehicle modifications
5. Vehicle load
6. Type, make, and condition of tires
7. Overall condition of the vehicle prior to the crash

Damage

The amount of damage sustained is one measure of crash severity.

It is most effective to document damage in a chronological order or use damage-location diagrams.

Damage should be noted both outside and inside of the vehicle.

An example of a chronological documentation of damage would be to start at the right front corner of the vehicle and move in a clockwise direction indicating the location and severity of all damage.

Other useful information that may be documented is:

1. The position of all windows
2. The current position of the headlight switch. It should be noted that a headlight switch should NOT be turned on to determine if the lights are functional. This may destroy evidence of use prior to the crash.
3. The position of the radio volume
4. The seat position as it relates to the size of the driver and passenger
5. The position and condition of seatbelts
6. Air bag deployment
7. Speedometer readings



8. Accelerator position and freedom of movement
9. Cargo space
10. Presence of alcoholic containers

Except under unfavorable conditions, the best time and place to match contact damage on vehicles to marks in the road and roadside is at the scene.

If there are gouges or scrapes on the pavement, there are nearly always corresponding wear, abrasions, or breakage of vehicle parts. This may be easy to see, for example, broken door handles, scraped fenders, or dented roofs if the vehicle has rolled over.

Damage to the underside of a vehicle is usually more significant and is often entirely overlooked. The easiest time to look for signs of road contact on the vehicle is when it is lifted for towing.

Be sure to photograph both the mark on the roadway and the corresponding damage and mark on the vehicle.

Technical Post Crash Inspection

There are times when it is appropriate to utilize additional personnel trained with an expertise in conducting a more detailed post crash inspection.

The post crash inspections are conducted with specific questions in mind such as:

1. Was there a pre-existing vehicle defect that contributed to the crash?
2. Was the crash caused by a tire failure?
3. Were the airbags deployed appropriately? If not, why?
4. What condition was the seatbelt? Was there any pretensioners fired as a result of the crash?
5. Was the vehicle's suspension braking and steering systems working properly prior to the crash?

In most cases a search warrant or written consent is required for this type of inspection. For information regarding sample search warrants for vehicle autopsies and CDR downloads, contact your local DA or the Maine State Police Traffic Safety Unit at 624-8939.

Information from the Roads

Many crash investigators expect someone to *tell* them what happened and so, they neglect to *look* for themselves. In some fatal crashes, nobody is left to tell the story and all you know about what took place must be learned from the study of the results of the crash. You can often get important and reliable information about the traffic crash by studying the road afterward.

The Roadway in General

The investigator must consider the physical characteristics and condition of the road and adjacent properties encountered by the persons involved in the crash.

Observations should be made from the driver's and pedestrian's line of sight.

Examine the crash scene for:

1. Obstructions alongside a roadway that limit a driver's ability to see existing or potential hazards or traffic-control devices. Particular attention should be given to billboards, cars parked too close to corners, building proximities to roadways, hedges, trees, embankments, etc.
2. Obstructions or defects on the roadway or shoulder which might cause a vehicle to go out of control, e.g. soft shoulders, shoulder lip, potholes, ruts, etc.



3. Inadequate or improper roadway design, alignment, grade, width of pavement or shoulder, superelevation of curves, etc.
4. Improperly placed, defective or inadequate traffic-control devices, i.e. traffic lights, stop signs, yield signs, etc.



5. Lack of street lighting. This is particularly important in pedestrian crashes.
6. Glare from fixed lights that impair a driver's view of traffic-control devices or other traffic, including pedestrians.



7. Slippery road surface caused by inclement weather, spilled oil, warm tar or asphalt, wooden surfaces such as bridges and moisture on dusty pavement or dirt roads.
8. Roadway alignment with positions of the sun or oncoming headlights. These conditions can adversely affect the driver's ability to see hazardous or potentially hazardous situations.

All physical features that can be adjusted to eliminate or minimize crashes, should be brought to the attention of local or state highway department officials for remedial action.

Evidence on the Roadway as a result of the Crash Events

Every motor vehicle crash leaves some physical sign of what occurred. If you can discover and *correctly* interpret them, such physical evidence can not be disputed. They can rarely explain all the events that took place in a crash, but they can often supplement statements by witnesses and other people involved, prove or disprove theories of what occurred, and guide the direction of further investigation.

It is important to record and measure evidence in the roadway.

Typical roadway marks as the result of a crash:

1. **Skidmarks** – A mark made on the surface of the road by a tire on a vehicle that is not rotating. A skidmark can only be made by a locked and sliding tire or a vehicle that is sliding completely sideways or perpendicular to the roadway. This could be due to braking, crash damage, or to other circumstances.



2. **Yaw marks** – Curved marks made by a tire that is rotating and sliding on pavement or other surface that is more or less parallel to its axis. These marks are sometimes called critical speed scuffmarks or sideslip marks. The marks contain angled striations caused by the gritty particles caught in the grooves or by the sidewall ribs.



3. **Acceleration marks** – Marks made when sufficient power is supplied to the drive wheels of a vehicles to make at least one of them spin or slip on the road surface.



4. **Flat tire marks** – A mark made by an over deflected tire, a tire which has too little air pressure in it for the load on it.

5. **Imprints** – An imprint is a mark on a roadway or other surface made without sliding by a rolling tire or a person’s foot. An imprint usually shows the pattern of the tire tread or shoe that made it.



6. **Scrub marks** – A tire scrub is a tire mark resulting from a wheel that is

locked or jammed during the crash and moving along the roadway until the vehicle stops or the wheel becomes free to rotate. The beginning of the scrub mark often helps in determining the area of impact.

Road Scars – A road scar is any sign that the road, roadside, or fixed object has been damaged or marred by a traffic crash.

1. **Scratches and scrapes** are made with little pressure. They show where sheet metal or body parts dragged across the surface or stronger metal parts moved lightly over an area.



2. **Gouges** – Places where pavement material has been dug out by strong metal parts such as frames, transmission housing, and control arms which have been forced down onto the roadway. The shape of the gouge may suggest how it was made.

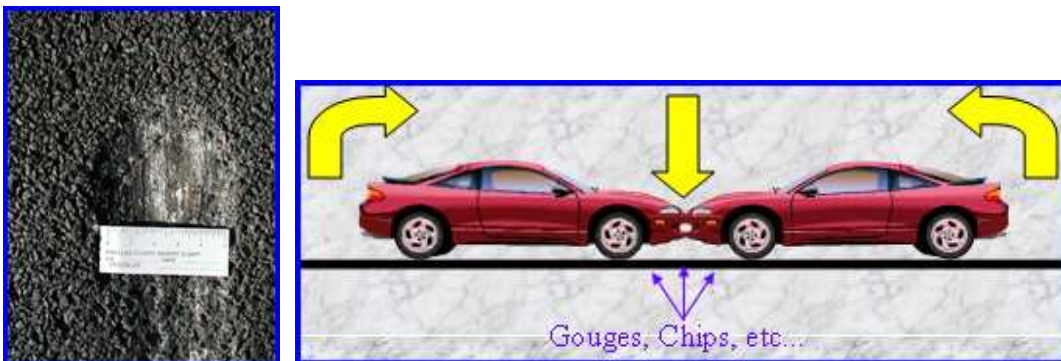

3. **Grooves** - A long narrow indentation or furrow caused by a bolt or other protrusion. Can show the direction of movement of the vehicle out of the crash.

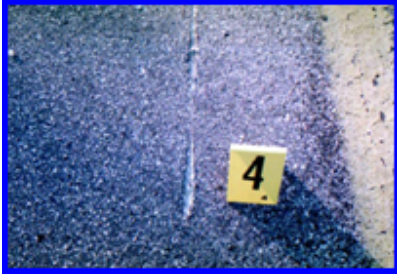

Debris – Debris is loose material scattered about at the scene as a result of a traffic crash. Debris may be dirt, liquids, vehicle parts, personal belongings and other things.

1. **Underbody debris** – (mud, rust, paint, snow, and sometimes gravel) sticks to the underside of fenders, engine block, and other parts. In a crash this comes loose in two ways:
 - a. The metal to which it is stuck bends or crinkles and debris chips off; and
 - b. The shock or the crash loosens it.

Remember, if a vehicle is moving when underbody debris is dislodged, the debris is also moving and does not drop straight to the ground. It continues to move in the direction the vehicle was moving and at approximately the same speed until it reaches the ground. Debris is usually a poor indicator of where the impact occurred but may be the only indicator. This type of evidence is helpful in establishing the direction of the applied force exerted on the vehicle.

2. **Liquid debris** – Coolant, battery acid, fuel, and other liquids may escape from containers after a crash. Blood and other liquids may also appear.



Meaning of the marks

In the above descriptions, each kind of mark on the road was described as though it were quite separate and by itself. Generally this is not the case.

The combination of marks can tell us about the sequence of events in a crash. Some of these combinations are clear while others are more puzzling.

You will remember that skid marks indicate a tire that was not rotating. Where they begin indicates where the brakes locked the wheels but not necessarily where the brakes were first applied. Where they end tells us where the brakes were released or the vehicle stopped.

Yaw marks before a crash indicate where steering started to swerve the vehicle but not exactly where steering began.

Thus it is the beginning, end, and where the changes in marks tell us where something unusual happened.

First Contact Point or Area of Impact

The first contact point (FCP) is the exact location on a vehicle, pedestrian, or other object touched in a crash. It can be the place on the road or ground closest to the first contact between the colliding objects.

Because FCP is very often difficult to determine exactly we often can only identify the Area of Impact (AOI).

Area of impact can often be identified by the following:

1. **Irregularity or offsets in skid marks** – very often a change in direction of skid marks or scrub marks will indicate the location of the tires when a force redirected the direction of the vehicle.



2. **Spatter on the road** is usually directly below the radiator or other container which liquid was forcibly ejected by the force of the crash. Spatter is most likely to occur at maximum engagement.



3. **Other kinds of vehicle debris** are much less reliable to determine the FCP. Most other kind of debris scatter widely. After a crash which dislodges underbody debris, the debris, while falling to the ground, continues to move in the direction of travel of the vehicle at the vehicle's speed until it strikes the ground, hits some underpart of the vehicle, or is stopped by whatever other object the vehicle struck. After striking the ground the debris may still slide or roll in more or less the same direction.



If debris is heaped in a limited area, especially if the heap is at the end of skidmarks, first contact or area of impact was probably close to the debris area.

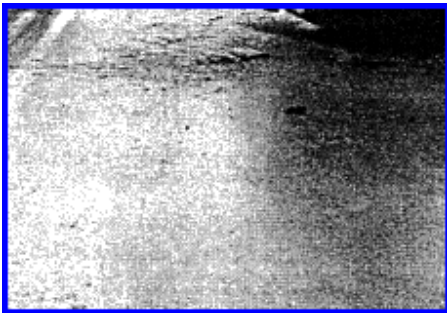

That is because 1) the vehicles were moving slowly and the debris did not scatter at impact or 2) neither vehicle moved significantly after impact.

If underbody debris is two feet above ground when it comes loose it will take a third of a second to hit the ground. If the vehicle is traveling 30 mph (44 feet per second) the debris will land approximately 15 feet from where it came loose provided it does not hit something first. Therefore, the AOI may be that far from the debris.

Off the ground

Sometimes a vehicle leaves the ground for a short distance. There are two main ways this can happen:

1. By a fall
2. By a flip

A Fall is a downward and onward movement in the air under the force of gravity after forward momentum carries an object beyond its supporting surface.

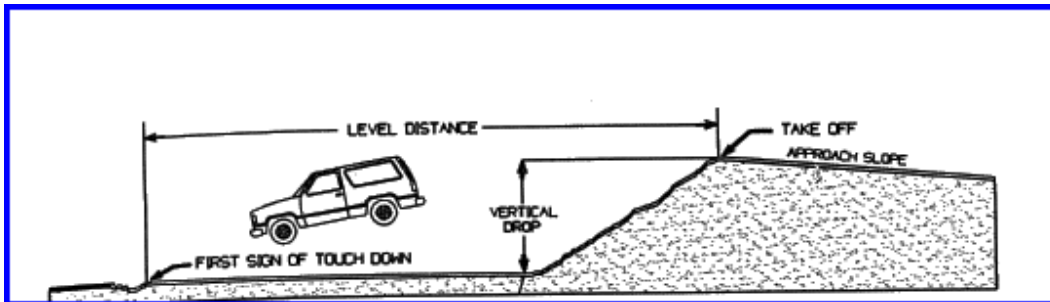

Signs of a fall – In a fall there are no marks between where a vehicle left the surface and where it landed.

A Flip is a sudden upward and onward movement off the ground when an object's horizontal movement is obstructed below its center of mass.

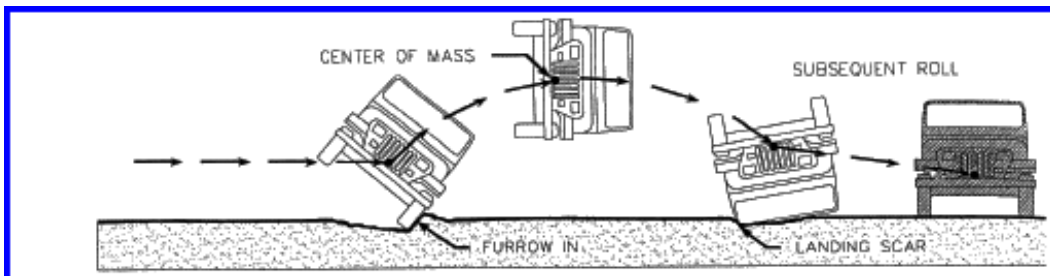

Signs of a flip – As in falls, the absence of any marks between takeoff and landing is the important fact to establish.

Flips can follow sideslipping or yaw when the tire hits a curb or furrows. When a tire slides sideways, make a furrow in loose material, the furrow deepens and the material piles up until the tire stops. This is a very distinct spot and is easy to locate.

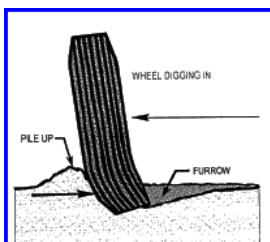

Final Positions

Final position is the exact location of a vehicle or body after a traffic crash. It may be controlled or uncontrolled.

Uncontrolled final positions are those reached by vehicles or bodies unintentionally after crashes. In serious or fatal crash locate the vehicle or body using measurements.

Controlled final positions are those to which vehicles or bodies are moved on purpose after a crash. For example, if a vehicle strikes a pedestrian and is then driven to the side of the road and parked. Likewise, if the pedestrian, after being struck, staggers or crawls off the road before falling to the ground, his or her position means less than if he did not move from where he first stopped. Such controlled or intentional final rest positions need to be noted but are generally less significant than uncontrolled final positions.

Photographing Crash Scenes

An important part of crash investigation is recording information so that it can be used later. Photography is an indispensable means of recording certain kinds of crash information.

An in depth discussion of photography techniques, lighting, film, and cameras is beyond the scope of this manual. Most police departments have invested in digital cameras that provide high resolution pictures.

Photos can be employed in two ways to preserve information:

1. As a permanent, accurate, unbiased record of something specifically observed by an investigator.
2. To capture the detailed appearance of something such as a mark on the road or damage to a vehicle, which may later reveal significant details that were not observed at the time the photo was taken.

Photos taken at a crash scene must depict a True and Accurate Representation of the scene and the items being photographed

The majority of the time police agencies take all of their own photographs, either by the investigating officer or specialized crime scene personnel. Some agencies employ professional photographers to take all on-scene photographs.

In serious or fatal crash investigations, photographs of the general scene should be taken as soon as possible before anything can be moved. In cases where some evidence or vehicles have been moved prior to your arrival, it would be acceptable to solicit any on-scene photographs taken by other persons prior to your arrival.

If you are going to mark evidence at the scene for measurement purposes, i.e. spray paint, crayon, or evidence markers, it is prudent to photograph the evidence both before and after marking the evidence.

Photographs can be broken down into three categories:

1. General At-Scene pictures
2. Road and road evidence pictures
3. Vehicle pictures

General At-Scene Photos

General at-scene pictures should include several views of the following:

1. Final positions of vehicles and bodies
2. Signs of the crash on the road
3. Signs of the crash on the roadside
4. Recognizable landmarks such as traffic signs which will identify the location on the road
5. The view that a driver may have had approaching the area of impact or the place where the vehicle left the roadway

Try to arrange each picture so that it will make distances easy to judge. If possible, take views straight down the road, preferably in the center of the lane the vehicle had been traveling. Or take views straight across the road at right angles to the edge of the pavement.

Likewise, if you can do it by moving your viewpoint, take the picture squarely toward a side or end of a vehicle as you would in photographing vehicle damage.

In choosing a viewpoint, consider what camera position will best capture most of the desirable elements.

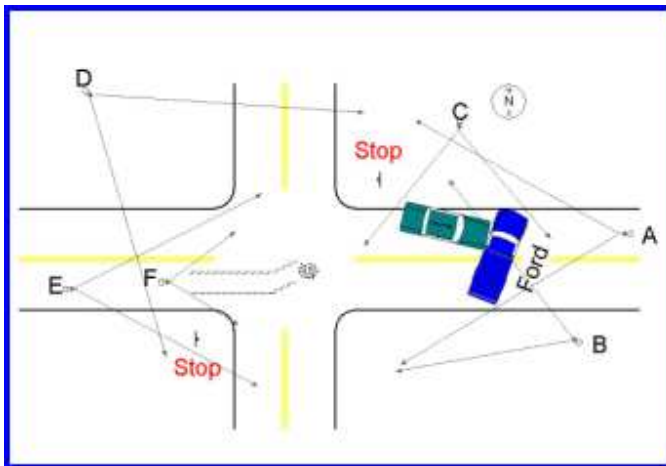

Position A gives a view straight down the road, includes both cars, some debris, and a landmark stop sign; the Ford obscures most of the Chevrolet and all tire marks.

Position B is a good view of the right side damage of the Ford, but it does not show whether the vehicles are actually touching each other. The tire marks and stop sign are too far to be clearly visible.

Position C is a good view of damage to the left side of the Chevrolet. It does clearly show that the cars are still engaged but it omits the tire marks and both landmark stop signs. It does not show the position on the road well.

Position D includes everything but is so far off (more than 80 feet) from anything significant to be very useful.

Position E shows everything that position D does, but better. It is close enough to show the tire marks well. It also shows the major debris. Aimed straight down the middle of a lane, it shows well the position of the vehicles on the road and indicates they are engaged. Thus, it is a better overall picture.

Now we can think of additional useful views. A closer view of the tire marks from position F shows their beginning well. Then a photo from direction B but much closer shows the condition of the whole right side of the Ford. A similar picture from the direction of C will do for the left side of the Chevrolet.

Example of general photos taken on a curved roadway

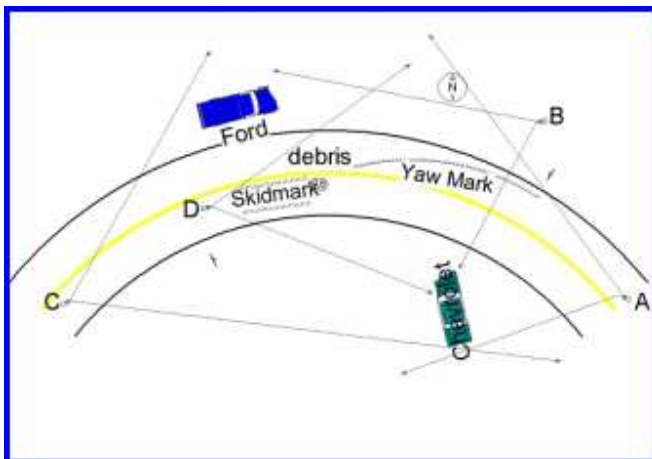

Road and Roadway Evidence Photos

After taking several general view pictures of the crash scene, more detailed pictures are required to capture tire marks, gouges, scrapes, and other evidence left as a result of the crash.

This requires close-ups of the road surface. Too often, however, such photos fail to identify where on the road the evidence was located. To avoid this difficulty, do one or more of the following:

1. Aim the camera to include a landmark fixed object such as a sign post or traffic signal.

2. If the detailed picture is straight downward toward the road, (for example to show striations in a yaw mark), take a second shot which includes a background object by which the location can be identified.
3. Near the detailed photo place an evidence marker which connects the photo with a measurements or other location identification.

It is also important to take photos of the road that depict:

1. View obstructions from each driver's perspective including:
 - a. Vertical view obstructions such as crests of hills, banks, or buildings beside the road.
 - b. Horizontal view obstructions at curves, intersections, and railroad grade crossings.
 - c. View obstructions from vegetation including trees, brush, or crops.
2. Sight lines for each driver involved in the crash.
3. Traffic control devices.

Vehicle Damage Photos

In crash reconstruction, we want to know such things as how one vehicle fits against another vehicle or fixed object at maximum engagement, from what direction the major force came from, whether it was involved in more than one contact during the crash, what areas received contact damage, and what parts of the vehicle were forced into contact with the road.

It is important to photograph the vehicle at the scene before the vehicle has been moved. This eliminates the possibility of further damage being caused by the removal of the vehicle.

At a minimum four photos of each vehicle involved are required, one from each side and end of the vehicle.

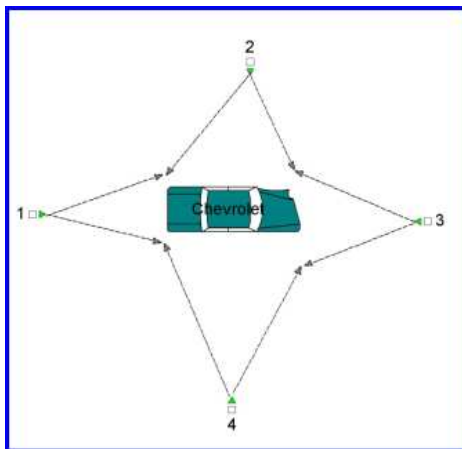

Once the general view photos have been taken, it is important to get more detailed views of both the interior and exterior of the vehicle. The detailed views should show such details as:

1. Imprints of one vehicle on another
2. Friction or abrasion marks
3. Paint transfers
4. Damage to lamps
5. Damage to the load
6. Sources of injury to pedestrians or occupants
7. Detailed damage to tires and wheels
8. Any damage to the underside of the vehicle

Evidence Collection

Photo/Video Footage

In addition to documenting the scene through the use of photos there are other sources of evidence that may be collected:

1. Security Camera – Investigate the possibility of crash footage captured on local business or residential security cameras.
2. Video from police cruiser video cameras
3. Possible video from witness cell phones.

It may be necessary to obtain a search warrant for some of the above listed items.

Blood Samples for All Operators

Mandatory submission to test - Title 29-A §2522 states If there is probable cause to believe that a death has occurred or will occur as a result of a crash, an operator of a motor vehicle involved in the motor vehicle crash shall submit to a chemical test, as defined in section 2401, subsection 3, to determine an alcohol level or drug concentration in the same manner as for OUI.

Administration of test - The investigating law enforcement officer shall cause a blood test to be administered to the operator of the motor vehicle as soon as practicable following the crash and may also cause a breath test or another chemical test to be administered if the officer determines appropriate. The operator shall submit to and complete all tests administered. Except as otherwise provided in this section, testing must be conducted in accordance with section 2521 (*Implied consent to chemical tests*).

Suspension – The Secretary of State shall suspend for a period of one year the license of a person who fails to submit to a test.

Vehicle Impound/Inventory

In all serious injury or fatal crash cases it is prudent to impound or “hold” a vehicle for a several days until it can be determined if the case warrants a post crash inspection, a Airbag/Powertrain Control Module download, or a review for prosecution by the District Attorney’s office.

It should be noted if prosecution is considered the vehicles must be held for a *reasonable* amount of time until any potential defense experts have the opportunity to examine the vehicles.

An impounded vehicle *should not* be released without first consulting with the District Attorney assigned to the case.

Inventory – All impounded vehicles should be inventoried for possible evidence and property recovery.

Cell Phones – Driver or passenger cell phone records may contain valuable information relating to pre-crash actions.

Log Books – In all commercial vehicle crashes, driver log books should be seized for review by The Maine State Police Commercial Vehicle Unit.

Drugs/Medications – Any drugs or medications found inside the vehicle or on persons involved in the crash should be collected as evidence and considered for possible contributing factors in the crash.

Airbag/Powertrain Control Modules – Many vehicles possess Airbag Control Modules and Powertrain Control Modules that can be downloaded by trained personnel. These modules often contain valuable information regarding the crash sequence. A list of vehicles that can be downloaded can be found on the Maine State Police Traffic Safety Unit website.

http://www.maine.gov/dps/msp/vehicles_inspections/crash_investigations

Search Warrant – In nearly all cases a search warrant must be obtained to gain access to the above listed evidence.

Additional Resources

In many serious injury or fatal crashes it is necessary to utilize additional resources with special training and skills.

A law enforcement officer who investigates a crash involving a bus or truck with a gross vehicle weight rating or a registered weight in excess of 10,000 pounds and engaged in commerce that results in the death of any person shall *request* a **certified crash reconstruction specialist** and the **Bureau of State Police Commercial Vehicle Enforcement Unit** to assist in the investigation of the crash. The Attorney General shall designate an assistant attorney general familiar with federal commercial vehicle laws and regulations to serve as a resource to any district attorney who initiates a prosecution arising from a crash involving a bus or truck with a

gross vehicle weight rating or a registered weight in excess of 10,000 pounds that results in the death of any person.

Crash Reconstruction specialist – Reconstruction specialists can be requested in most all serious injury or fatal crashes, but should, in all cases, be requested if an emergency vehicle was involved or the crash will result in criminal prosecution.

Maine State Police Commercial Vehicle Unit – An MSP Commercial Vehicle Enforcement Unit (CVEU) Specialist must be requested when any crash involving a bus or truck with a gross vehicle weight rating or registered weight in excess of 10,000 pounds and is engaged in commerce results in the death of any person. An MSP CVEU specialist **may** be requested when any crash involves a bus or truck with a gross vehicle weight rating or registered weight in excess of 10,000 pounds.

Forensic Mapping Unit – May be requested when a crash involves commercial vehicles as defined above, serious or fatal injuries or serious or fatal injuries involving prosecution.

Vehicle Autopsy Unit – May be requested when a serious personal injury or fatal crash occurs and there is reason to believe a mechanical failure contributed to the crash.

Evidence Response Team (ERT)/Detectives – May be requested when a crash results in serious or fatal injuries and may involve prosecution. The ERT/Detectives are useful when there is a great deal of scene evidence to be processed, in-depth interviews to be conducted, extensive photos need to be taken, or DNA to be collected.

Notifications

Medical Examiner - Must be notified in all fatal crashes

District Attorney - Must be called on all fatal and serious injury crashes

Crash Reconstruction Specialist – May be called for serious crashes involving more than one vehicle or single vehicle crashes with prosecution.

Commercial Vehicle Enforcement Unit - Must be called if the crash involves a bus or truck with a gross vehicle weight rating or registered weight in excess of 10,000 pounds and is engaged in commerce, that results in the death of any person.

US Dept. of Transportation/Federal Motor Carrier Safety Administration - Must be called (207-622-8358) when:

1. Any highway crash involving the death of 5 or more persons.
2. Any commercial vehicle crash involving a fatality, numerous injuries, extensive property damage, fires, or explosions involving hazardous materials.
3. Spectacular or catastrophic major highway crashes.
4. Any crash that might cause a major highway to be closed for two or more hours.

Maine Department of Transportation – Must be called (207-624-3339) when:

1. All school bus crashes involving death or injury.
2. Any fatal or serious injury crash where road conditions or traffic control devices caused or contributed to the crash.
3. Vehicle/Train Crashes.
4. Truck Crashes involving spills of cargo onto the roadway.
5. Crashes involving the transportation of hazardous materials.

Department of Agriculture – Must be called (207-287-3841) when:

1. Any crash involving damage to a cargo of food produce of any type.

Department of Environmental Protection – Must be called (1-800-482-0777) when:

1. Any crash involving damage to a cargo of any type of hazardous material that could cause water or other environmental problem.

Next of Kin – When a crash results in fatal injuries the closest next of kin must be notified as soon as practical. When notification is made, document the name and time the notification was made.

It is very important to give next of kin information on how to contact the investigating officer.

Funeral Home – When a crash results in fatal injuries, a funeral home must be called to remove the deceased from the scene. This can be coordinated with the Medical Examiner and/or family.

Wrecker/Tow Company – Wreckers or tow vehicles need to be called to remove the involved vehicles from the scene. This should be coordinated so scene measurements, photos and evidence collection can be completed before removal.

1. Specify what type of wrecker is needed for vehicles.
2. Clarify if the wrecker company must keep vehicle(s) in a secure location.
3. Advise if any special equipment is needed to retrieve vehicles.

Investigating Vehicle/Train collisions



When motorists disregard signs, lights, bells, and gates at highway-rail grade crossings, the consequences are often deadly. A collision involving a vehicle and a train is twenty times more likely to result in a fatality than a crash involving motor vehicles.

As law enforcement officers, the odds are you will respond to these incidents. Being familiar with railroad terminology and operations is of paramount importance as you consider your safety and the safety of others. The following tips may save your life and reduce the chance of making the situation worse.

Tips for Law Enforcement Officers

- When approaching a highway-rail grade crossing collision, do not stop your car on or near the tracks.
- Be aware hazardous materials may be involved. With the conductor's assistance, ascertain from the train's consist and bills of lading what materials are being transported. For expert advice on hazardous materials call CHEM-TREC at 1-800-424-9300.
- Protect yourself, the scene, witnesses and approaching vehicles. Care for the injured as in any other crash scene.
- If multiple tracks are present, be aware train traffic may continue to pass on unaffected tracks.
- Obtain operator information from the conductor and engineer. The engineer's certification card and employee identification may be available. A state motor vehicle operator's license is not required to operate a train.
- Do not climb on, crawl under or over the rail cars or engine without the knowledge of the crew and only if you have had specific training. Trains have unseen moving parts that can seriously injure or kill you.
- Look for evidence of suicide. The motor vehicle may be in park or neutral and the emergency brake may be set. Check to see if the keys are in the ignition, and inspect the roadway for signs of skid marks prior to impact.
- Record the lead locomotive's engine number, and the total number of rail cars and engines. If rail cars are stopped at the crossing, obtain their identification numbers as well.

- Before releasing the train, determine that the locomotive's headlight, alerting (ditch) lights, horn and bell were in operating condition.
- Record the U.S. DOT crossing number. This will be found on the signal gate, sign post, or on the crossing bungalow.
- All locomotives operating over 30 miles per hour are equipped with an event recorder. This instrument samples and records speed, time, braking and other vital information. Railroad officials will assist investigating officers in obtaining this information as needed.
- If the crossing is equipped with active warning devices (lights, bells, gates), observe if they are working. Also, check to see if passive warning devices (crossbucks, advance warning signs, and pavement markings) are in place.
- Locate witnesses, and take detailed statements from each. Include their observations of the active or passive warning devices and the actions of the motor vehicle operator.
- The local railroad police or company officer will assist you in the investigation. He or she is familiar with train operations and is a valuable resource.

General Information

- The approach of a train triggers "active warning devices" (flashing red lights, bells, and gates). They begin operating at least 20 seconds before the arrival of the fastest train on that line.
- In case of electrical or mechanical failure, active warning devices are designed to default to the fail-safe or "active" mode.
- If active warning devices fail-safe or appear to be malfunctioning, or their view is obstructed, report it to the appropriate railroad immediately.
- Enforcing trespass laws can alleviate vandalism and save lives. Vandals have been responsible for causing signal malfunctions that cause collisions.

If you have questions about engineering, regulatory, or operating issues, contact the appropriate railroad, highway authority, state department of transportation or the Federal Railroad Administration.

Report Writing

A crash involving serious or fatal injuries requires a more detailed and substantial investigative report. The report should contain detailed chronological descriptions of all activities by all investigators involved.

All investigative reports must be completed within 30 days of the date of the event. The Traffic Crash Report Form 13:20A, **MAY NOT** be held for submission with the completed investigative report and must be submitted in compliance with M.R.S.A. Title 29A, section 2251. During the investigation, if any information is identified which requires changes to the 13:20A electronic crash report, an amendment can be submitted to the Maine Crash Database by the investigating officer.

Fatal Investigative Report

INVESTIGATIVE REPORT SUBJECT TITLES

SYNOPSIS:

A synopsis is a brief and concise description of the crash and the results of the investigation. The synopsis should include the date, time and location of the crash, a brief description of the crash event, and any conclusions regarding causation or contributing factors as a result of the investigation.

KILLED AND INJURED:

Full name, sex, race, date of birth, and address of each person killed or injured.

Cause of death and type of injuries.

Copy of Death Certificate if possible.

DETAILS OF INVESTIGATION:

Follow a sequential chronological reporting by dates and time as to what occurred throughout the officer's full investigation.

Keep paragraphs short and report only known facts. Double space between all paragraphs.

COURT OR CRIMINAL RECORD CHECK:

All involved operators, pedestrians, or other suspects.

NCIC CHECK:

All involved operators, pedestrians, other suspects.

CRASH HISTORY CHECK:

All involved operators, pedestrians, or other suspects.

PHYSICAL CONDITION AND HEALTH HISTORY:

All involved operator, pedestrians, or other suspects.

ALCOHOL INVOLVEMENT:

All involved operators, deceased passengers or pedestrians or bicycle operators that a blood or breath sample was taken from and the chemical results of these tests.

DRUG INVOLVEMENT:

All involved operators, deceased passengers or pedestrians or bicycle operators who were known to be taking drugs prior to or at the time of the Crash.

CARBON MONOXIDE INVOLVEMENT:

All involved operators or passengers who were tested for carbon monoxide and the results of those tests.

VEHICLE DAMAGE:

List color, year, make, model, registration number and serial number of each involved vehicle. Include mileage reading and full inspection sticker data. Describe all observed damage by clockwise sequence for the outside areas followed by inside compartment areas.

List known mechanical condition of each unit prior to Crash and any mechanical defects found after the Crash. Focus attention on condition of brakes, tires, lights, steering, and exhaust systems or other condition that may have caused or attributed to the Crash.

List the name of persons who examined the vehicle after the Crash and where each vehicle is presently stored.

TRAFFIC AND HIGHWAY CONDITIONS:

Fully describe the known traffic and highway conditions that existed when the Crash occurred. Information on traffic signal controls and posted highway signs should be included, in addition to known speed limits. List any factor that may have caused or attributed to the Crash. Include any sight line obstructions.

WEATHER CONDITIONS:

Describe known weather conditions at the time of the Crash. List factors that may have caused or contributed to the Crash.

LIGHT CONDITIONS:

Describe known light conditions at the time of the Crash. Include natural and artificial lighting. List factors that may have caused or contributed to the Crash.

COURT ACTION TAKEN OR CONTEMPLATED:

Describe court action taken or contemplated against any involved person. Pleas, findings, fines, and jail sentences should be included with the full court data, if available.

OPINION (S) OF INVESTIGATOR AS TO CAUSE AND GENERAL CONCLUSIONS:

Opinion(s) of the investigator should be based on known facts that were discovered throughout the investigation. It should include a primary causation factor, secondary causation factor and other related cause factors. General conclusions should contain a brief summary of the results of investigation.

The investigator may wish to have this section of the report placed on a separate confidential sheet and identified as such.

LIST FULL NAMES, ADDRESSES, AND HOME TELEPHONE NUMBERS OF ALL WITNESSES:

Briefly state after each witness' name what the witness can testify to in relation to the fatal Crash and if a signed statement was obtained.

LIST FULL NAMES AND TITLES OF ALL INVESTIGATORS AND OTHER OFFICERS:

List the full names, titles, and agencies of all investigators and officers that participated in the fatal Crash investigation.

ENCLOSURES:

List and identify all documents that are attached to the investigator's fatal Crash report, such as:

- a. Signed Statements:
- b. Photographs:
- c. Physical Evidence Lists:
- d. Special Diagrams:
- e. Court and Criminal Records:
- f. Medical Reports:
- g. Chemical and Laboratory Results:
- h. Miscellaneous Documents and Other Reports, and
- i. Receipts for clothing, money and other articles.

File 14-1 First Report of Fatal Teletype

In all fatal crashes a File 14-1 First Report of Fatal Teletype must be completed and sent to the following agencies:

1. State Police Traffic Safety Unit
2. Medical Examiners Office
3. Attorney General's Office
4. Bureau of Motor Vehicles
5. Bureau Highway Safety
6. State Bureau of Identification

Format and explanation of First Report of Fatal

Whenever a department investigates a fatal traffic accident, a First Report of Fatal message shall be sent statewide to APB Maine (FILE-14I), which will automatically direct the message to BMV,

Maine and SP Traffic Division via a File 14-I Administrative Message, attention Chief Medical Examiner and Traffic Division (example message/format follow).

If all information is not available at the time the message is sent, a supplemental ADDED information message should be sent as soon as that information is available. It is recommended that item #11, notification of next of kin, be conducted BEFORE sending a message, to avoid release to the media before notification is made.

Attention: State Police RCC's: **Items 6, 7, & 8, shall NOT be released to the Press.** Be sure item 11 has been conducted before releasing.

Format:

1. Date and Hour of occurrence: Whether area is rural or urban:

Route number or Street of occurrence: City or Town of occurrence:

2. Investigating officer(s) assigned to investigation: Complaint Number:

3. Date of notification of fatal accident or delayed death, time received and by whom:

4. Assign unit number to each vehicle involved for the following:

Name and Address of Operator Age DOB Vehicle (Year/Make/Model)

Unit #1 _____

Unit #2 _____

(Refer to vehicle(s) by unit number above in remainder of report)

5. Status of driver's license of EACH driver:

6. If physical defect contributed to accident, list name type of defect:

7. Names of driver(s) or pedestrian(s) who had been drinking:

8. Was alcohol test taken? If Yes, name(s) of person(s) tested:

9. Give names of deceased using seat belts, if passenger, indicate Unit number:

10. Name, address, age, and date of birth of EACH person killed: (Designate if driver, passenger, pedestrian, bike or sled rider)

(If passenger, indicate in which unit number)

11. Date and time of notification of death to next of kin; by whom:

12. Name, address, age, nature of injury and where taken, if injured: (If passenger, indicate in which unit number)

13. Did highway/street conditions or inadequate road signs/signals contribute?

14. PRIMARY CAUSE of this accident:

15. Why and how accident occurred: Refer to vehicles by Unit numbers:

16. Name of Medical Examiner:

17. Autopsy: Yes or No:

18. If motorcycle, was operator wearing a helmet: Yes or No:

18A If motorcycle, was passenger wearing a helmet: Yes or No:

(If no motorcycle involved, lines 18 & 18A should read: N/A)

19. Is accident being reconstructed: Yes or No; If Yes, officers name:

20. Is accident being forensically mapped: Yes or No; If Yes, officer's name

Sources

1. *Manual on Classification of Motor Vehicle Traffic Accidents* (ANSI D16.1 – 2007), National Safety Council, Itasca, Ill.
http://downloads.nsc.org/pdf/D16.1_Classification_Manual.pdf
2. *Model Minimum Uniform Crash Criteria Third Edition*, June 2008, U.S. Department of Transportation, Washington, DC www.mmucc.us
3. *Manual on Uniform Traffic Control Devices*, 2009, U.S. Department of Transportation, Federal Highway Administration, Washington, DC
4. *Traffic Records Systems Data Dictionary Release 5.0.0* (ANSI D20.1 - 2010), American Association of Motor Vehicle Administrators, AAMVA, Inc 4301 Wilson Boulevard Suite 400 Arlington, Virginia
<http://www.aamva.org/aamva/DocumentDisplay.aspx?id=%7B0287CE5F-165E-4855-93FE-5EEC2AF9AFB1%7D>
5. Baker, Kenneth S., *Traffic Collision Investigation*, 2001, The Northwestern University Center for Public Safety, Evanston, Ill.
6. Ferdico, John N., *Maine Motor Vehicle Statutes*, Title 29-A, 2010, Swan Island Press, Bowdoinham, Me
7. Ferdico, John N., *Maine Criminal Statutes*, Title 17-A, 2010, Swan Island Press, Bowdoinham, Me
8. *Crash Data Collection for Commercial Motor Vehicles*, August 2007, Federal Motor Carrier Safety Administration, National Institute for Safety Research, Inc., Oakland, Md
9. Rivers, R.W., *Technical Traffic Accident Investigator's Handbook*, 1997, Charles C. Thomas Publisher, LTD, Springfield, Ill.